

CONCRETE | LOG CABINS | OUTDOOR PLAY | CARPORTS | GARAGES | ANIMAL HOUSES | ROOFS
DECKING | GARDEN PARTITIONS | GARDEN STORAGE | DECORATION | GARDEN TIMBER | GARDEN FURNITURE | WELLNESS

Tuindeco

*durable
wood*

*more than 3.500
products*

2019

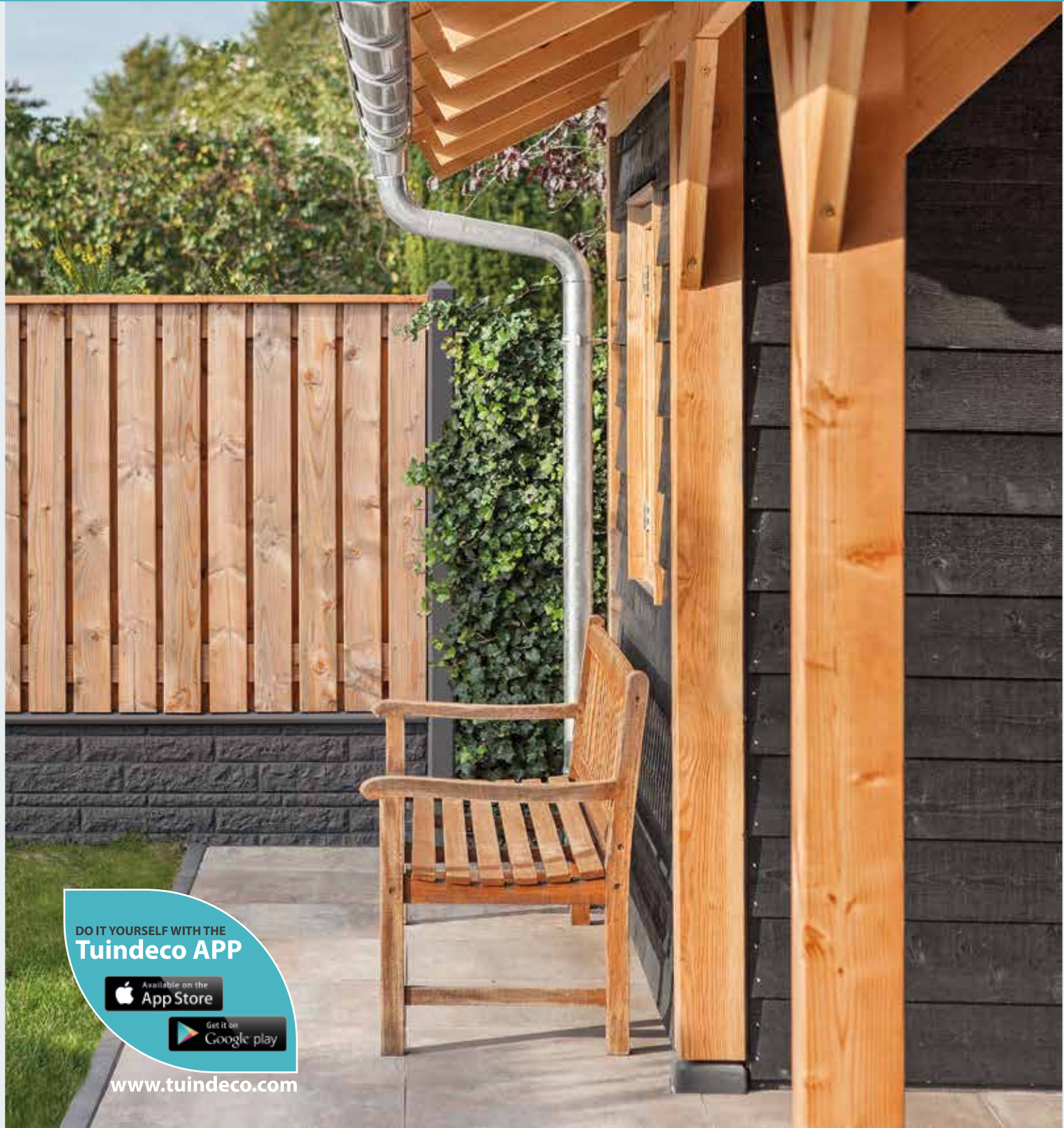

DO IT YOURSELF WITH THE
Tuindeco APP



www.tuindeco.com

DO IT YOURSELF WITH THE TUINDECO APP

"See what a log cabin would look like in your own garden!"



The **Tuindeco APP** makes it very easy for you to place a virtual log cabin in your garden. Simply a question of scanning the ground, selecting your favourite log cabin and placing it in the desired position. Complete your design in just **3 steps**.

SCAN THE SURFACE



1

SELECT A PRODUCT



2

POSITION IT AND YOU'RE DONE!



3

The APP also has a handy **QR Code Scanner**. Aim the camera at the image in the catalogue and the APP will quickly bring you more information about the log cabin. That way, you can be sure you are making the right choice.

With the Tuindeco APP, you no longer need worry about size or whether it will suit or fit in the garden. Besides, this APP enables you to view the inside of the log cabin too. Have you decided on a different log cabin? View this virtual log cabin in your garden in a flash.

If you would like to get other opinions, you can share the design with family, friends and acquaintances.

Download the APP free and start designing your garden straight away!

- ✓ Easy to use
- ✓ Will inspire you
- ✓ Share via social media
- ✓ Additional product information

GARDEN PARTITIONS & CONCRETE SYSTEMS	
Concrete	5
Garden fences	25
Garden fence gates	39
Mesh and trellises	42
Natural partitions	47
Fencing	48
GARDEN TIMBER	
Posts	54
Construction wood	55
Garden planks	56
Roundwood	61
FLOOR & TERRACE	
Gravel and grit	64
Decking elements	64
Garden tiles	69
GARDEN STORAGE & DECORATION	
Pergolas	72
Garden storage	73
Accessories	79
OUTDOOR PLAY	
Play centers	81
Children's furniture	89
Play accessories	91
Playhouses	94
ANIMAL HOUSES	
Animal houses	98
GARDEN FURNITURE	
Wicker garden furniture	102
Parasols	125
Terrace heating	127
WELLNESS	
Hottubs	130
Saunas	131
ROOFS, CARPORTS & GARAGES	
Shade nets and shade canvases	137
Arbours and pavilions	138
Garage and carports	149
DIY constructions	167
Modular roofs	177
Larch elements	218
LOG CABINS & GARDEN HOUSES	
Log cabin gazebos	223
Log cabins	230
Specials	387
New Record	395
Log cabin accessoires	398
OTHER	
Decorations	411
Ironmongery	411
Concrete accessories	413
Maintenance products	416

Tuindeco has made a deliberate choice to create the correct balance between People, Planet and Profit in its business activities. As well as focusing on new market opportunities, growth and innovation Tuindeco places a considerable emphasis on protecting our environment, society and humankind. For many years now Tuindeco has done its utmost to ensure that the wooden materials and products it supplies comply with its required standards for sustainable quality, and that wood sourced from illegal logging is never purchased or used.

Tuindeco has been a member of the Netherlands Forest Stewardship Council (FSC) partner network since 2013. Being one of the largest garden timber suppliers in the Netherlands, this is how Tuindeco realises its ambitions to have forest stewardship implemented globally and contribute to the protection and responsible management of forests all over the world. Furthermore, we purposely go one step further than required under the European Forest Law Enforcement Governance & Trade Decree (FLEGT) introduced in March 2013, which aims to ban the importation of illegal wood.

As a supplier of products that use the natural forest resources, it is crucial for us to know exactly where these materials come from and how the forests in question are managed. As you can imagine, it is of paramount importance for us to be able to continue with the supply of wooden products in the future. The use of FSC wood and our partnership with FSC Netherlands are the perfect means of realising these ambitions.



FLEGT stands for Forest Law Enforcement, Governance and Trade.

The FLEGT action plan was introduced as early as 2003, with the aim of reducing illegal logging through promoting and implementing sustainable and legal forestry management.

The first volunteer partnership agreement with Indonesia came into effect on since the 15th November 2016, and from this date, all wood products imported into Europe from Indonesia have to meet the FLEGT regulations.

In the Netherlands, the NVWA is the responsible authority that inspects all incoming goods verifying their authenticity and compliance with the regulations agreed in the permit. In collaboration with customs, the NVWA checks samples of the goods being sent.



Tuindeco is FSC (Forest Stewardship Council) and PEFC (Programme for the Endorsement of Forest Certification) certified.

The PEFC, the Programme for the Endorsement of Forest Certification, is a global non-profit and non-governmental organisation whose purpose is to promote sustainable forest management. The ultimate objective of PEFC is the establishment of sound management for all forests on the planet. By means of a system of certification, forest proprietors are able to demonstrate their compliance with PEFC requirements in terms of forest management. Wood can safely and responsibly be logged from PEFC-certified forests. Chain of Custody-certified companies further along the chain can process this wood in PEFC-certified products. For more information, visit the PEFC international website: www.pefc.org.



The FSC promotes responsible forest management. For more information, visit the FSC international website: www.fsc.org. Here you will also find the 10 FSC principles of responsible forest management.

Forest proprietors, wood traders, environmental groups and local residents' representatives must work together to globally improve forest management. One of the main objectives in this respect is to establish financially viable and ecologically and socially responsible wood production methods.

The FSC's core activity is to ensure proper management for the earth's forests, both tropical and non-tropical. The FSC certification system enables forest proprietors who comply with the agreements to distinguish themselves from those whose forests are poorly managed.

Moreover, the FSC makes certified wood recognisable for consumers, thus guaranteeing them that the wood originates from well-managed forests and that the entire supply chain is monitored. The instrument used in this is certification, both for forest management and for the supply chain. Certificates are issued by one of the independent organisations that have been acknowledged by the FSC.

Rather than formulate the demands for proper forest management themselves, the PEFC has relied on international stakeholder consultations to provide more than 250 requirements. These internationally defined criteria are endorsed by 149 countries. In addition to economical and ecological requirements, the PEFC also prescribes strict social conditions in respect of social working standards (International Labour Organization). Ultimately we have to be sure that a product is FSC or PEFC-certified only if it has the FSC or PEFC quality mark. It is the task of independent inspectors to enforce compliance with the regulations.



The KOMO quality mark is issued by the Netherlands Wood Inspection Agency Foundation (SKH). The tasks of this foundation are to issue quality certificates and to supervise, among other things, the high-pressure impregnation of wood with a fungus and insect-repelling, life-span extending product.

This foundation aims for all quality-related processes within the entire wood industry to be certified according to pre-established guidelines, from basic resources to final product. The guidelines for wood impregnation contain, among other things, the requirements with which impregnating liquids, impregnation processes and impregnated products must comply. Tuindeco always impregnates wood in accordance with the latest guidelines.

In short:

A KOMO certification guarantees an environmentally responsible wood impregnation process and a well-impregnated final product. You can recognise KOMO-certified Tuindeco products by their KOMO hallmark.

In this catalogue, FSC- or PEFC-certified products are marked with the FSC or PEFC hallmark.



There are various ways of creating a partition in your garden. Concrete Systems of various heights are available for this which together with garden fences ensure privacy. Our range is so extensive that you can make an attractive, natural and permanent partition yourself. You can be as creative as you want in this when designing your garden.



CONCRETE SYSTEM 180 WITH BOTTOM PANELS

The concrete posts for this system are available in various lengths, thereby accommodating height differences. The concrete posts have a fixed rebate dimension that is suitable for both smooth and small patterned panels. When using a small patterned panel, a wooden cover is only possible if you shorten the garden screen to a height of 178cm.

If you decide to use the concrete posts in combination with arched fences you must use special filler blocks at the underside of the rebate. These can be found on page 23.

The 308cm long concrete posts have a rebate that is suitable for 2 smooth bottom panels or 2 small patterned bottom panels. It is also possible to use 1 wide patterned panel, but then you must fill the underside with special filler blocks, which can be found on page 23. Both possibilities in combination with 180cm high garden fences.

For a very comprehensive range of garden fences for this wood-concrete system, please see pages 26-39.





Concrete post, white/grey with diamond-shaped head and bevelled edge

- 1.52180** 10.0x10.0x180cm - Intermediate model for fences 90cm high
- 1.52180E** 10.0x10.0x180cm - End model for fences 90cm high
- 1.52220** 10.0x10.0x220cm - Intermediate model for fences 120cm high
- 1.52250** 10.0x10.0x250cm - Intermediate model for fences 150cm high
- 1.52280** 10.0x10.0x280cm - Intermediate model suitable for both straight and arched fences 180cm high
- 1.52280H** 10.0x10.0x280cm - Corner model suitable for both straight and arched fences 180cm high
- 1.52280E** 10.0x10.0x280cm - End model suitable for both straight and arched fences 180cm high
- 1.52280T** 10.0x10.0x280cm - T-model suitable for both straight and arched fences 180cm high
- 1.52700** 10.0x10.0x280cm - Intermediate model with Cable duct suitable for both straight and arched fences 180cm high
- 1.52308** 10.0x10.0x308cm - Intermediate model for 2 smooth panels and suitable for both straight and arched fences 180cm high
- 1.52308H** 10.0x10.0x308cm - Corner model for 2 smooth panels and suitable for both straight and arched fences 180cm high
- 1.52308E** 10.0x10.0x308cm - End model for 2 smooth panels and suitable for both straight and arched fences 180cm high



Concrete post, charcoal with diamond-shaped head and bevelled edge

- 1.53180** 10.0x10.0x180cm - Intermediate model for fences 90cm high
- 1.53180E** 10.0x10.0x180cm - End model for fences 90cm high
- 1.53220** 10.0x10.0x220cm - Intermediate model for fences 120cm high
- 1.53250** 10.0x10.0x250cm - Intermediate model for fences 150cm high
- 1.53280** 10.0x10.0x280cm - Intermediate model suitable for both straight and arched fences 180cm high
- 1.53280H** 10.0x10.0x280cm - Corner model suitable for both straight and arched fences 180cm high
- 1.53280E** 10.0x10.0x280cm - End model suitable for both straight and arched fences 180cm high
- 1.53280T** 10.0x10.0x280cm - T-model suitable for both straight and arched fences 180cm high
- 1.53700** 10.0x10.0x280cm - Intermediate model with Cable duct suitable for both straight and arched fences 180cm high
- 1.53308** 10.0x10.0x308cm - Intermediate model for 2 smooth panels and suitable for both straight and arched fences 180cm high
- 1.53308H** 10.0x10.0x308cm - Corner model for 2 smooth panels and suitable for both straight and arched fences 180cm high
- 1.53308E** 10.0x10.0x308cm - End model For 2 smooth panels and suitable for both straight and arched fences 180cm high



Concrete post, with round head and bevelled edge

- 1.52703** 10.0x10.0x280cm - Intermediate model white/grey suitable for both straight and arched fences 180cm high
- 1.53703** 10.0x10.0x280cm - Intermediate model charcoal suitable for both straight and arched fences 180cm high



Concrete post, with diamond-shaped head, 3 grooves and bevelled edge

- 1.58470** 10.0x10.0x280cm - Intermediate model suitable for both straight and arched fences 180cm high
- 1.58570** 10.0x10.0x280cm - Intermediate model suitable for both straight and arched fences 180cm high



The lightweight concrete post is much stronger than the standard concrete post thanks to its special composition. Due to its lower weight, the lightweight concrete post is easier to handle.



Concrete post, white/grey, light-weight with diamond-shaped head and bevelled edge

- 1.52800** 10.0x10.0x280cm - Intermediate model suitable for both straight and arched fences 180cm high
- 1.52800H** 10.0x10.0x280cm - Corner model suitable for both straight and arched fences 180cm high
- 1.52800E** 10.0x10.0x280cm - End model suitable for both straight and arched fences 180cm high
- 1.52800T** 10.0x10.0x280cm - T-model suitable for both straight and arched fences 180cm high



Concrete post, charcoal, light-weight with diamond-shaped head and bevelled edge

- 1.53800** 10.0x10.0x280cm - Intermediate model suitable for both straight and arched fences 180cm high
- 1.53800H** 10.0x10.0x280cm - Corner model suitable for both straight and arched fences 180cm high
- 1.53800E** 10.0x10.0x280cm - End model suitable for both straight and arched fences 180cm high
- 1.53800T** 10.0x10.0x280cm - T-model suitable for both straight and arched fences 180cm high

THE SLIMLINE CONCRETE POST ®

The Slimline concrete post of 7.5x7.5cm is a slimmer version of the standard 10.0x10.0cm concrete post.

Despite its smaller dimensions, this post is exceptionally strong due to the composition of the raw materials used. The mechanical properties are comparable with 10.0x10.0cm posts.

Thanks to its lower weight, the Slimline concrete post is easier to handle.

Slimline concrete post, white/grey with diamond-shaped head and bevelled edge ®

- 1.58600** 7.5x7.5x280cm - Intermediate model
- 1.58600E** 7.5x7.5x280cm - End model
- 1.58700** 7.5x7.5x280cm - Intermediate model
- 1.58700E** 7.5x7.5x280cm - End model

New

These specially developed products for Tuindeco are patented



Smooth bottom panels

Bottom panels feature 2 smooth visible sides and a drainage roof

- 1.55184** H24.0xD3.5xL184cm white/grey bottom panel feature 2 smooth visible sides and a drainage roof
- 1.55224** H24.0xD3.5xL224cm white/grey bottom panel feature 2 smooth visible sides and a drainage roof
- 1.56184** H24.0xD3.5xL184cm charcoal bottom panels feature 2 smooth visible sides and a drainage roof
- 1.56224** H24.0xD3.5xL224cm charcoal bottom panels feature 2 smooth visible sides and a drainage roof



Rock patterned panel small, white/grey

Bottom panels feature 2 visible sides

1.55526 H26.0xD4.8xL184cm



Rock patterned panel small, charcoal

Bottom panels feature 2 visible sides

1.56526 H26.0xD4.8xL184cm



Slate patterned panel small, white/grey

Bottom panels feature 2 visible sides

1.55926 H26.0xD4.8xL184cm



Slate patterned panel small, charcoal

Bottom panels feature 2 visible sides

1.56926 H26.0xD4.8xL184cm



Roman patterned panel small slate, white/grey

Bottom panels feature 2 visible sides

1.55726 H26.0xD4.8xL184cm

New



Roman patterned panel small, charcoal

Bottom panels feature 2 visible sides

1.56726 H26.0xD4.8xL184cm

New



shiplaped panel small, white/grey

Bottom panels feature 2 visible sides

1.55826 H26.0xD4.8xL184cm

New



shiplaped panel small, charcoal

Bottom panels feature 2 visible sides

1.56826 H26.0xD4.8xL184cm

New





CONCRETE SYSTEM 150 WITH 2 BOTTOM PANELS

The 280cm concrete posts have a fixed rebate dimension in which 2 smooth or 2 small, patterned bottom panels can be incorporated. A finial should be placed on top on the panels. When choosing small bottom plates take into account that only 1 finial can be used with a 150cm fence. A choice therefore has to be made between a concrete finial on the bottom panel or a wooden finial on top of the garden fence. When you want a cap on both, it is only possible when you trim the garden screen of 150cm.

This system is suitable for 150cm fences. For a very comprehensive range of garden fences for this wood-concrete system, please see pages 26-39.

Concrete post, white/grey with diamond-shaped head and bevelled edge

For 2 smooth or 2 patterned panels small

- 1.58285** 10.0x10.0x280cm - Intermediate model suitable for fences 150cm high
- 1.58285H** 10.0x10.0x280cm - Corner model suitable for fences 150cm high
- 1.58285E** 10.0x10.0x280cm - End model suitable for fences 150cm high
- 1.58285T** 10.0x10.0x280cm - T-model suitable for fences 150cm high
- 1.52702** 10.0x10.0x280cm - Intermediate model with cable entry suitable for fences 150cm high



Concrete post, charcoal with diamond-shaped head and bevelled edge

For 2 smooth or 2 patterned panels small

- 1.58385** 10.0x10.0x280cm - Intermediate model suitable for fences 150cm high
- 1.58385H** 10.0x10.0x280cm - Corner model suitable for fences 150cm high
- 1.58385E** 10.0x10.0x280cm - End model for fences 150cm high
- 1.58385T** 10.0x10.0x280cm - T-model suitable for fences 150cm high
- 1.53702** 10.0x10.0x280cm - Intermediate model with cable entry for fences 150cm high



Smooth bottom panels

Bottom panels feature 2 smooth visible sides and a drainage roof

- 1.55184** H24.0xD3.5xL184cm white/grey bottom panel feature 2 smooth visible sides and a drainage roof
- 1.55224** H24.0xD3.5xL224cm white/grey bottom panel feature 2 smooth visible sides and a drainage roof
- 1.56184** H24.0xD3.5xL184cm charcoal bottom panels feature 2 smooth visible sides and a drainage roof
- 1.56224** H24.0xD3.5xL224cm charcoal bottom panels feature 2 smooth visible sides and a drainage roof



Patterned panel, small white/grey rock pattern

Bottom panels feature 2 visible sides

1.55526 H26.0xD4.8xL184cm



Patterned panel, small charcoal rock pattern

Bottom panels feature 2 visible sides

1.56526 H26.0xD4.8xL184cm



Patterned panel, small white/grey slate pattern

Bottom panels feature 2 visible sides

1.55926 H26.0xD4.8xL184cm



Patterned panel, small charcoal slate pattern

Bottom panels feature 2 visible sides

1.56926 H26.0xD4.8xL184cm



Patterned panel, small white/grey roman pattern

Bottom panels feature 2 visible sides

1.55726 H26.0xD4.8xL184cm



New

Patterned panel, small charcoal roman pattern

Bottom panels feature 2 visible sides

1.56726 H26.0xD4.8xL184cm



New

Patterned panel small, white/grey shiplap

Bottom panels feature 2 visible sides

1.55826 H26.0xD4.8xL184cm



New

Patterned panel small, charcoal shiplap

Bottom panels feature 2 visible sides

1.56826 H26.0xD4.8xL184cm



New

Garden fence gates

The concrete finial is mounted on top of the upper most panel

1.59510 180cm white/grey



Garden fence gates

The concrete finial is mounted on top of the upper most panel

1.59515 180cm charcoal





CONCRETE SYSTEM 130 WITH PATTERNED PANELS

The 280-cm concrete posts have a fixed rebate in which 2 wide patterned panels can be incorporated. It is also possible to use 2 small rock patterned panels with a rock patterned filling panel on top. The advantage of the latter option is that the panels can be handled easily due to their lower weight. The patterned panels are joined together with tongue and groove making the result visually identical to 2 wide rock patterned panels. A finial should be placed on top on these panels as finish.

This system is suitable for 130-cm-high fences.

For a very comprehensive range of garden fences for this wood-concrete system, please see pages 26-39.

Concrete post, white/grey with diamond-shaped head and bevelled edge

For patterned panels

- 1.58030** 10.0x10.0x280cm - Intermediate model for 2 patterned panels and suitable for fences 130cm high
- 1.58030H** 10.0x10.0x280cm - Corner model for 2 patterned panels and suitable for fences 130cm high
- 1.58030E** 10.0x10.0x280cm - End model for 2 patterned panels and suitable for fences 130cm high
- 1.58030T** 10.0x10.0x280cm - T-model for 2 patterned panels and suitable for fences 130cm high



Concrete post, charcoal with diamond-shaped head and bevelled edge

For patterned panels

- 1.58001** 10.0x10.0x280cm - Intermediate model for 2 patterned panels and suitable for fences 130cm high
- 1.58001H** 10.0x10.0x280cm - Corner model for 2 patterned panels and suitable for fences 130cm high
- 1.58001E** 10.0x10.0x280cm - End model for 2 patterned panels and suitable for fences 130cm high
- 1.58001T** 10.0x10.0x280cm - T-model for 2 patterned panels and suitable for fences 130cm high



Patterned panels white/grey rock pattern

Patterned panels feature 2 visible sides

- 1.55526** H26.0xD4.8xL184cm
- 1.55520** H20.0xD4.8xL184cm
- 1.55536** H36.0xD4.8xL184cm



Patterned panels charcoal rock pattern

Bottom panels feature 2 smooth visible sides

- 1.56526** H26.0xD4.8xL184cm
- 1.56520** H20.0xD4.8xL184cm
- 1.56536** H36.0xD4.8xL184cm



Patterned panels white/grey slate pattern

Patterned panels feature 2 visible sides

- 1.55936** H36.0xD4.8xL184cm



Patterned panels charcoal slate pattern

Bottom panels feature 2 smooth visible sides

- 1.56936** H36.0xD4.8xL184cm



Patterned panels white/grey wood pattern

Bottom panels feature 2 smooth visible sides

- 1.55636** H36.0xD4.8xL184cm



Patterned panels charcoal wood pattern

Bottom panels feature 2 smooth visible sides

- 1.56636** H36.0xD4.8xL184cm



Concrete finial white/grey

The concrete finial is mounted on top of the upper most panel

- 1.59510** 180cm white/grey



Concrete finial charcoal

The concrete finial is mounted on top of the upper most panel

- 1.59515** 180cm charcoal





WOOD-CONCRETE SYSTEM WITH GROOVED POST AND STACKING PROFILES

The concrete posts for this system have a length of 280cm. The rebate of these posts are 3cm wide with a length of 173cm. Under the normal groove there is a wider groove of 4.5cm width and a height of 26cm. A smooth or small patterned bottom panel can be incorporated in this undermost wide groove.

The 173cm groove can be filled further with wooden stack profiles. To finish, you can use a wooden coupling cap, see page 16, or the specially developed galvanised U-profiles. Due to the effect of the wooden stack profiles, this finish is highly recommended.

For a comprehensive range of stack profiles for this system, see pages 59 and 61

Wood-concrete system white/grey with wider groove at bottom



1.50410 10.0x10.0x280cm
Intermediate model

1.50410E 10.0x10.0x280cm
End model

New

Wood-concrete system charcoal with wider groove at bottom



1.51410 10.0x10.0x280cm
Intermediate model

1.51410E 10.0x10.0x280cm
End model

New

Galvanized U-profile ®
for stacking profiles



1.59150 U-profile 29mm
1.59150Z Cover cap 29mm
Powder coated Black

These specially developed products for Tuindeco are patented.

New



Patterned panel, small white/grey rock pattern

Bottom panels feature 2 visible sides

1.55526 H26.0xD4.8xL184cm



Patterned panel, small charcoal rock pattern

Bottom panels feature 2 visible sides

1.56526 H26.0xD4.8xL184cm



Patterned panel, small white/grey slate pattern

Bottom panels feature 2 visible sides

1.55926 H26.0xD4.8xL184cm



Patterned panel, small charcoal slate pattern

Bottom panels feature 2 visible sides

1.56926 H26.0xD4.8xL184cm



Patterned panel small white/grey roman pattern

Bottom panels feature 2 visible sides

1.55726 H26.0xD4.8xL184cm

New



Patterned panel, small charcoal roman pattern

Bottom panels feature 2 visible sides

1.56726 H26.0xD4.8xL184cm

New



Patterned panel small white/grey shiplap

Bottom panels feature 2 visible sides

1.55826 H26.0xD4.8xL184cm

New



Patterned panel small, charcoal shiplap

Bottom panels feature 2 visible sides

1.56826 H26.0xD4.8xL184cm

New



Smooth bottom panel

Bottom panels feature 2 smooth visible sides and a drainage roof

1.55180 H24.0xD3.5xL180cm

1.55184 H24.0xD3.5xL184cm

1.56180 H24.0xD3.5xL180cm

1.56184 H24.0xD3.5xL184cm





270cm grooved concrete posts have a 3.8cm wide and 204cm long groove. The groove fits 1 smooth bottom panel (180cm) with a 180cm garden fence on top, finished with a wooden coupling cap, see page 16, or the specially developed U-profiles, see page 13 and 31. A 270cm grooved post can be filled with 8.5 smooth bottom panels. You can opt for the standard smooth bottom panel or the piling panel. You can finish this with one cover cap and finial or opt for a wooden coupling cap, see page 16, or the specially developed U-profiles, see page 13 and 31.

280cm grooved concrete posts have a 3.8cm wide and 216cm long groove. The groove fits 1 wider patterned panel with a 180cm garden fence on top. A 280cm grooved post can be filled with 9 smooth bottom panels. You can opt for the standard smooth bottom panel or the piling panel. You can also place 6 wider patterned panels in this post. You can finish this with one cover cap and finial or opt for a wooden coupling cap, see page 16, or the specially developed U-profiles, see page 13 and 31.

316cm grooved concrete posts have a 3.8cm wide and 252cm long groove. The groove fits 2 wider patterned panels with a 180cm garden fence on top. A 316cm grooved post can be filled with 10.5 smooth bottom panels. You can opt for the standard smooth bottom panel or the piling panel. The groove fits 7 wider patterned panels. You can finish this with one cover cap and finial or opt for a wooden coupling cap, see page 16, or the specially developed U-profiles, see page 13 and 31.

Ask your reseller for more information regarding all options for these slot post systems.

For a comprehensive range of garden fences for these systems, please see page 26-39 (excluding the Prive garden fence)



Patterned panels white/grey rock pattern

Patterned panels feature 2 visible sides



- 1.55536** H36.0xD4.8xL184cm
- 1.55526** H26.0xD4.8xL184cm
- 1.55520** H20.0xD4.8xL184cm

Patterned panel small white/grey roman pattern

Bottom panels feature 2 visible sides



- 1.55726** H26.0xD4.8xL184cm



Patterned panels white/grey slate pattern

Patterned panels feature 2 visible sides



- 1.55936** H36.0xD4.8xL184cm
- 1.55926** H26.0xD4.8xL184cm

Patterned panel small white/grey shiplap

Bottom panels feature 2 visible sides



- 1.55826** H26.0xD4.8xL184cm



Patterned panels white/grey wood pattern

Bottom panels feature 2 smooth visible sides



- 1.55636** H36.0xD4.8xL184cm

Concrete piling plate white/grey

Bottom panels feature 2 visible sides



- 1.55300** H24.0xD3.5xL184cm
Tongue-and-groove
- 1.55300E** H24.0xD3.5xL184cm
End panel

Smooth bottom panel, white/grey

Bottom panels features 2 visible sides

The patterned panels of 184cm are only to be used with a complete concrete stack system, not in combination with fences.



- 1.55180** H24.0xD3.5xL180cm
- 1.55184** H24.0xD3.5xL184cm

Concrete finial white/grey

The concrete finial is mounted on top of the upper most panel

- 1.59510** 180cm white/grey



Concrete cover cap white/grey

- 1.59550** Intermediate model
- 1.59550H** Corner model
- 1.59550E** End model
- 1.59550T** T-model



Patterned panels charcoal rock pattern

Bottom panels feature 2 smooth visible sides



- 1.56536** H36.0xD4.8xL184cm
- 1.56526** H26.0xD4.8xL184cm
- 1.56520** H20.0xD4.8xL184cm

Patterned panel small charcoal roman pattern

Bottom panels feature 2 visible sides



- 1.56726** H26.0xD4.8xL184cm

New

Patterned panels charcoal slate pattern

Bottom panels feature 2 smooth visible sides



- 1.56936** H36.0xD4.8xL184cm
- 1.56926** H26.0xD4.8xL184cm

Patterned panel small charcoal shiplap

Bottom panels feature 2 visible sides



- 1.56826** H26.0xD4.8xL184cm

New

Patterned panels charcoal wood pattern

Bottom panels feature 2 smooth visible sides



- 1.56636** H36.0xD4.8xL184cm

Concrete piling panel charcoal

Bottom panels feature 2 visible sides



- 1.56300** H24.0xD3.5xL184cm
Piling panel with
togue-and- groove
- 1.56300E** H24.0xD3.5xL184cm
End pannel with
groove

Concrete bottom panels charcoal

Bottom panel features 2 visible sides The patterned panels of 184 cm are only to be used with a complete concrete stack system, not in combination with fences.



- 1.56180** H24.0xD3.5xL180cm
- 1.56184** H24.0xD3.5xL184cm

Concrete finial charcoal

The concrete finial is mounted on top of the upper most panel

- 1.59515** 180cm charcoal



Concrete cover cap charcoal

- 1.59555** Intermediate model
- 1.59555H** Corner model
- 1.59555E** End model
- 1.59555T** T-model





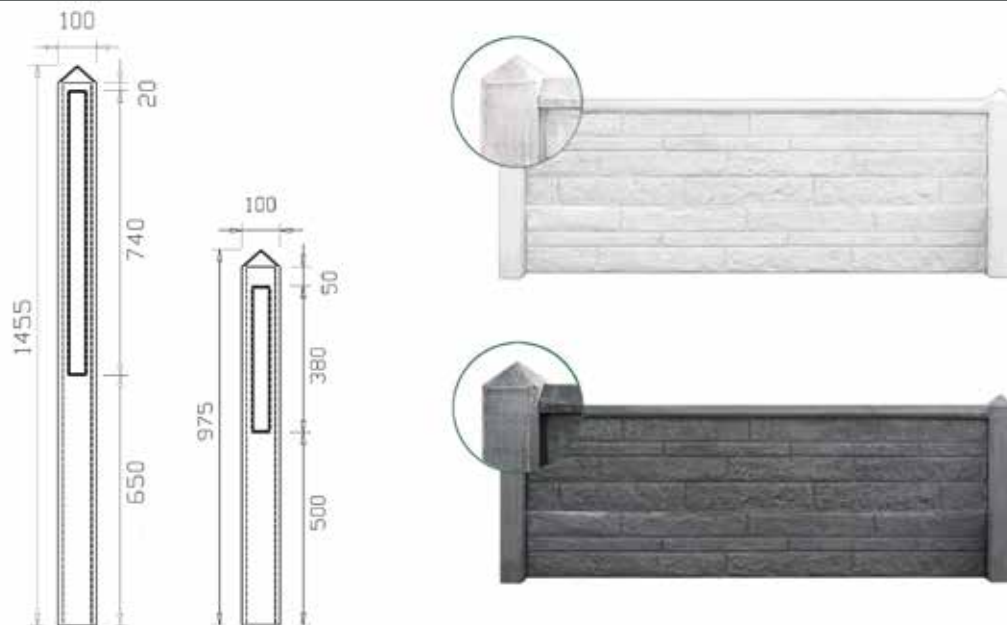

GARDEN FENCE POSTS AND BORDER POSTS

Both wide patterned and small patterned bottom panels, as well as smooth bottom panels, can be incorporated in this system. The post dimensions overview specifies how many panels are required to perfectly fill the posts. You can use this system for soil retention and low fencing. This can be finished with a concrete finial.



Concrete garden fence and border post, white/grey with diamond head and bevelled edge

- 1.52104** 10.0x10.0x104cm - Intermediate model for 1 smooth or 1 wide patterned panel
- 1.52104H** 10.0x10.0x104cm - Corner model for 1 smooth or 1 wide patterned panel
- 1.52104E** 10.0x10.0x104cm - Endpost for 1 smooth or 1 wide patterned panel
- 1.52104T** 10.0x10.0x104cm - T-model for 1 smooth or 1 wide patterned panel
- 1.52140** 10.0x10.0x145cm - Intermediate model for 3 smooth or 2 wide patterned panel
- 1.52140H** 10.0x10.0x145cm - Corner model for 3 smooth or 2 wide patterned panel
- 1.52140E** 10.0x10.0x145cm - End model for 3 smooth or 2 wide patterned panel
- 1.52140T** 10.0x10.0x145cm - T-model for 3 smooth or 2 wide patterned panel



Concrete diamond-shaped head garden fence and border post, charcoal with bevelled edge

- 1.53104** 10.0x10.0x104cm - Intermediate model for 1 smooth or 1 wide patterned panel
- 1.53104H** 10.0x10.0x104cm - Corner model for 1 smooth or 1 wide patterned panel
- 1.53104E** 10.0x10.0x104cm - End model for 1 smooth or 1 wide patterned panel
- 1.53104T** 10.0x10.0x104cm - T-model for 1 smooth or 1 wide patterned panel
- 1.53140** 10.0x10.0x145cm - Intermediate model for 3 smooth or 2 wide patterned panel
- 1.53140H** 10.0x10.0x145cm - Corner model for 3 smooth or 2 wide patterned panel
- 1.53140E** 10.0x10.0x145cm - End model for 3 smooth or 2 wide patterned panel
- 1.53140T** 10.0x10.0x145cm - T-model for 3 smooth or 2 wide patterned panel



Concrete bottom panels

Bottom panels feature 2 smooth visible sides and a drainage roof

- 1.55180** H24.0xD3.5xL180cm white/grey
- 1.55184** H24.0xD3.5xL184cm white/grey
- 1.56180** H24.0xD3.5xL180cm charcoal
- 1.56184** H24.0xD3.5xL184cm charcoal

Patterned panel white/grey rock pattern

Bottom panels feature 2 visible sides



- 1.55500** H36.0xD4.8xL180cm
- 1.55536** H36.0xD4.8xL184cm
- 1.55526** H26.0xD4.8xL184cm

Patterned panel small white/grey roman pattern

Bottom panels feature 2 visible sides



- 1.55726** H26.0xD4.8xL184cm

New

Patterned panels white/grey slate pattern

Patterned panels feature 2 visible sides



- 1.55936** H36.0xD4.8xL184cm
- 1.55926** H26.0xD4.8xL184cm

Patterned panel small white/grey shiplap

Bottom panels feature 2 visible sides



- 1.55826** H26.0xD4.8xL184cm

New

Patterned panels white/grey wood pattern

Bottom panels feature 2 smooth visible sides



- 1.55636** H36.0xD4.8xL184cm

Concrete finial white/grey

The concrete finial is mounted on top of the upper most panel



- 1.59510** 180cm white/grey



Patterned panels charcoal rock pattern

Bottom panels feature 2 visible sides



- 1.56500** H36.0xD4.8xL180cm
- 1.56536** H36.0xD4.8xL184cm
- 1.56526** H26.0xD4.8xL184cm

Patterned panel small charcoal roman pattern

Bottom panels feature 2 visible sides



- 1.56726** H26.0xD4.8xL184cm

New

Patterned panels charcoal slate pattern

Bottom panels feature 2 smooth visible sides



- 1.56936** H36.0xD4.8xL184cm
- 1.56926** H26.0xD4.8xL184cm

Patterned panel small charcoal shiplap

Bottom panels feature 2 visible sides



- 1.56826** H26.0xD4.8xL184cm

New

Patterned panels charcoal wood pattern

Bottom panels feature 2 smooth visible sides



- 1.56636** H36.0xD4.8xL184cm

Concrete finial, charcoal

The concrete finial is mounted on top of the upper most panel

- 1.59515** 180cm charcoal





1.59001
Concrete fitting kit
yellow galvanised
 Set of 4
 Incl. patent bolts



1.59002
Concrete fitting kit
Stainless steel
 Set of 4
 Incl. patent bolts



1.59003
Concrete corner or wall profile



1.59607
Concrete sinking prevention
D5xØ25cm
 For concrete posts/pad footings



1.59606
Concrete filling blocks white/grey
10cm
 For grooved posts



1.59605
Concrete filling blocks charcoal
10cm
 For grooved posts



1.93005
Quick-drying concrete 25kg
 Ready-made, just add water



1.93006
Concrete mortar 25kg
 Ready-made, just add water

REQUIRED QUANTITY IN KG

Pit depth > 30cm 45cm 60cm
 Pit 20x20cm 20kg 28kg 37kg
 Pit 25x25cm 32kg 46kg 62kg
 Pit 30x30cm 46kg 67kg 90kg



1.59013
Stone adhesive kit for concrete
 Tube 290ml
 For gluing finials and cover caps

Due to the effects of the weather and water absorption, the concrete posts and panels will discolour after time. What's more, concrete has the tendency to "bleed", which is due to calcium formation. You can prevent both problems by having your concrete posts and panels coated ex-works. The coating is also available separately so that you can coat your concrete posts and panels yourself.



Example uncoated posts



Example coated posts



Example uncoated posts



Example coated posts

The advantages of coating:

- Gives an attractive smooth finish
- Protects and extends the life span
- Strongly reduces the water reduction
- Longer colour retention
- Makes concrete easy to clean thoroughly
- Prevents frost and heat damage
- Surface structure remains fully intact
- Effective against moss, algae and fungi
- Prevents water, dirt, oil and acid penetration
- Reduces calcium formation
- UV-neutral



Example coated panels



Example coated panels



Example coated panels

Coated charcoal posts

- 1.53703C** Intermediate model, smooth with half-round head 10.0x10.0x280cm
- 1.58570C** Intermediate model, 3 grooves with diamond-shaped head 10.0x10.0x280cm
- 1.53180C** Intermediate model with diamond-shaped head 10.0x10.0x180cm
- 1.53180EC** End model with diamond-shaped head 10.0x10.0x180cm
- 1.53220C** Intermediate model with diamond-shaped head 10.0x10.0x220cm
- 1.53250C** Intermediate model with diamond-shaped head 10.0x10.0x250cm
- 1.53280C** Intermediate model with diamond-shaped head 10.0x10.0x280cm
- 1.53700C** Intermediate model with cable duct 10.0x10.0x280cm
- 1.53280HC** Corner model with diamond-shaped head 10.0x10.0x280cm
- 1.53280EC** End model with diamond-shaped head 10.0x10.0x280cm
- 1.53280TC** T-model with diamond-shaped head 10.0x10.0x280cm
- 1.53308C** Intermediate model with diamond-shaped head 10.0x10.0x308cm
- 1.53308HC** Corner model with diamond-shaped head 10.0x10.0x308cm
- 1.53308EC** End model with diamond-shaped head 10.0x10.0x308cm
- 1.58385C** Intermediate model with diamond-shaped head 10.0x10.0x280cm
- 1.58385HC** Corner model with diamond-shaped head 10.0x10.0x280cm
- 1.58385EC** End model with diamond-shaped head 10.0x10.0x280cm
- 1.58385TC** T-model with diamond-shaped head 10.0x10.0x280cm
- 1.58001C** Intermediate model with diamond-shaped head 10.0x10.0x280cm
- 1.58001HC** Corner model with diamond-shaped head 10.0x10.0x280cm
- 1.58001EC** End model with diamond-shaped head 10.0x10.0x280cm
- 1.51700C** Intermediate model grooved post 10.0x10.0x270cm
- 1.51700EC** End model grooved post 10.0x10.0x270cm
- 1.51410C** Intermediate model for wood piling system 10.0x10.0x275cm
- 1.51410EC** End model for wood piling system 10.0x10.0x275cm
- 1.57280C** Intermediate model grooved post 11.5x11.5x280cm
- 1.57280HC** Corner model grooved post 11.5x11.5x280cm
- 1.57280EC** End model grooved post 11.5x11.5x280cm
- 1.57280TC** T-model grooved post 11.5x11.5x280cm
- 1.57316C** Intermediate model grooved post 11.5x11.5x316cm
- 1.57316HC** Corner model grooved post 11.5x11.5x316cm
- 1.57316EC** End model grooved post 11.5x11.5x316cm

- 1.53104EC** Intermediate model garden fencing/border 10.0x10.0x104cm
- 1.53104HC** Corner model garden fencing/border 10.0x10.0x104cm
- 1.53104EC** End model garden fencing/border 10.0x10.0x104cm
- 1.53104TC** T-model garden fencing/border 10.0x10.0x104cm
- 1.53140C** Intermediate model garden fencing/border 10.0x10.0x145cm
- 1.53140HC** Corner model garden fencing/border 10.0x10.0x145cm
- 1.53140EC** End model garden fencing/border 10.0x10.0x145cm
- 1.53140TC** T-model garden fencing/border 10.0x10.0x145cm
- 1.53800C** Light-weight intermediate model with diamond-shaped head 10.0x10.0x280cm
- 1.53800HC** Light-weight corner model with diamond-shaped head 10.0x10.0x280cm
- 1.53800EC** Light-weight end model with diamond-shaped head 10.0x10.0x280cm
- 1.53800TC** Light-weight T-model with diamond-shaped head 10.0x10.0x280cm

Coated charcoal bottom panels

- 1.56184C** Bottom panel 3.5x24.0x184cm
- 1.56180C** Bottom panel 3.5x24.0x180cm
- 1.56224C** Bottom panel 3.5x24.0x224cm
- 1.56536C** Rock pattern bottom panel 4.8x36.0x184cm
- 1.56936C** Slate pattern bottom panel 4.8x36.0x184cm
- 1.56636C** Wood pattern bottom panel 4.8x36.0x184cm
- 1.56500C** Rock pattern bottom panel 4.8x36.0x180cm
- 1.56300C** Piling plate with tongue-and-groove 3.5x24.0x184cm
- 1.56300EC** Piling plate with only groove 3.5x24.0x184cm
- 1.56526C** Rock pattern bottom panel, narrow 3.5x26.0x184cm
- 1.56836C** Slate pattern bottom panel, narrow 4.8x26.0x184cm
- 1.56726C** Roman pattern bottom panel, narrow 4.8x26.0x184cm
- 1.56826C** Tongue-and-groove wood pattern bottom panel, narrow 4.8x26.0x184cm
- 1.56520C** Rock pattern filling panel 4.8x20.0x184cm

Coated charcoal coloured finials and cover caps

- 1.59515C** Concrete finial
- 1.59555C** Cover cap, intermediate model
- 1.59555HC** Cover cap, corner model
- 1.59555EC** Cover cap, end model
- 1.59555TC** Cover cap, T-model



- 1.59016** Concrete coating 1ltr, suitable for coating concrete
Consumption approx. 1 ltr. per 6m² (3 poles and 3 plates)



- 1.59017** Repair set 100ml, suitable for coated concrete, incl. brush



8.14180
Aalsmeer - Garden Fence
 H180xW180cm
 19 planks of D1.0xW10.0cm
 Intermediate slat: D1.5xW5.0cm
 Rough, impregnated pine, stapled



8.14186
Haaksbergen - Garden Fence
 H180xW180cm
 19 planks of D1.5xW14.0cm
 Intermediate slat: D1.5xW14.0cm
 Planed, impregnated pine,
 Stainless steel screwed



8.14181
Ermelo - Garden Fence
 H180xW180cm
 19 planks of D1.0xW10.0cm
 Intermediate slat: D1.5xW5.0cm
 Rough, impregnated pine, stapled



8.14190
Venray - Garden Fence
 H180xW180cm
 19 planks of D1.7xW14.0cm
 Intermediate slat: D1.7xW14.0cm
 Planed, impregnated pine,
 Stainless steel screwed



8.14182
Den Haag - Garden Fence
 H180xW180cm
 15 planks of D1.5xW14.0cm
 Intermediate slat: D1.5xW7.0cm
 Planed, impregnated pine, screwed



8.14191
Prive - Garden Fence
 H195xW180cm
 19 planks of D1.6xW14.0cm
 Intermediate slat: D1.6xW14.0cm
 Planed, impregnated pine,
 Stainless steel screwed



8.14183
Maastricht - Garden Fence
 H180xW180cm
 15 planks of D1.5xW14.0cm
 Intermediate slat: D1.5xW7.0cm
 Planed, impregnated pine, screwed



8.14188
Monaco - Garden Fence
 H180xW180cm
 19 planks of D1.6xW14.0cm
 Intermediate slat: none
 Fitted with upper and lower slats
 Planed, impregnated pine,
 Stainless steel screwed



8.14184
Uden - Garden Fence
 H180xW180cm
 15 planks of D1.5xW14.0cm
 Intermediate slat: D1.5xW7.0cm
 Planed, impregnated pine,
 Stainless steel screwed



8.80086
Twente - Garden Fence
 H180xW180cm
 11 planks of D1.8xW20.0cm
 Intermediate slat: none
 Fitted with upper and lower slats
 Planed, impregnated pine,
 Stainless steel screwed



8.14185
Erica - Garden Fence
 H180xW180cm
 15 planks of D1.6xW14.0cm
 Intermediate slat: D1.6xW7.0cm
 Planed, impregnated pine,
 Stainless steel screwed



8.14189
Losser - Garden Fence
 H180xW180cm
 11 planks of D1.8xW20.0cm
 Intermediate slat: none
 Fitted with upper and lower slats
 Rough, impregnated pine,
 Stainless steel screwed





8.10180
Coevorden 180 - Garden Fence
 H180xW180cm
 15 planks of D1.6xW14.0cm
 Intermediate slat: D1.6xW14.0cm
 Planed, impregnated pine,
 Stainless steel screwed



8.11180
Vasse 180 - Garden Fence
 H180xW180cm
 17 planks of D1.6xW14.0cm
 Intermediate slat: D1.6xW14.0cm
 Planed, impregnated pine,
 Stainless steel screwed



8.10150
Coevorden 150 - Garden Fence
 H150xW180cm
 15 planks of D1.6xW14.0cm
 Intermediate slat: D1.6xW14.0cm
 Planed, impregnated pine,
 Stainless steel screwed



8.11150
Vasse 150 - Garden Fence
 H150xW180cm
 17 planks of D1.6xW14.0cm
 Intermediate slat: D1.6xW14.0cm
 Planed, impregnated pine,
 Stainless steel screwed



8.10130
Coevorden 130 - Garden Fence
 H130xW180cm
 15 planks of D1.6xW14.0cm
 Intermediate slat: D1.6xW14.0cm
 Planed, impregnated pine,
 Stainless steel screwed



8.11130
Vasse 130 - Garden Fence
 H130xW180cm
 17 planks of D1.6xW14.0cm
 Intermediate slat: D1.6xW14.0cm
 Planed, impregnated pine,
 Stainless steel screwed



8.10090
Coevorden 90 - Garden Fence
 H90xW180cm
 15 planks of D1.6xW14.0cm
 Intermediate slat: D1.6xW14.0cm
 Planed, impregnated pine,
 Stainless steel screwed



8.11090
Vasse 90 - Garden Fence
 H90xW180cm
 17 planks of D1.6xW14.0cm
 Intermediate slat: D1.6xW14.0cm
 Planed, impregnated pine,
 Stainless steel screwed



8.10918
Coevorden verloop - Garden Fence
 H180>90xW180cm
 15 planks of D1.6xW14.0cm
 Intermediate slat: D1.6xW14.0cm
 Planed, impregnated pine,
 Stainless steel screwed



8.11918
Vasse verloop - Garden Fence
 H180>90xW180cm
 17 planks of D1.6xW14.0cm
 Intermediate slat: D1.6xW14.0cm
 Planed, impregnated pine,
 Stainless steel screwed





8.12180
Enschede 180 - Garden Fence
 H180xW180cm
 19 planks of D1.6xW14.0cm
 Intermediate slat: D1.6xW14.0cm
 Planed, impregnated pine,
 Stainless steel screwed



8.13180
Zaltbommel 180 - Garden Fence
 H180xW180cm
 21 planks of D1.6xW14.0cm
 Intermediate slat: D1.6xW14.0cm
 Planed, impregnated pine,
 Stainless steel screwed



8.12150
Enschede 150 - Garden Fence
 H150xW180cm
 19 planks of D1.6xW14.0cm
 Intermediate slat: D1.6xW14.0cm
 Planed, impregnated pine,
 Stainless steel screwed



8.13150
Zaltbommel 150 - Garden Fence
 H150xW180cm
 21 planks of D1.6xW14.0cm
 Intermediate slat: D1.6xW14.0cm
 Planed, impregnated pine,
 Stainless steel screwed



8.12130
Enschede 130 - Garden Fence
 H130xW180cm
 19 planks of D1.6xW14.0cm
 Intermediate slat: D1.6xW14.0cm
 Planed, impregnated pine,
 Stainless steel screwed



8.13130
Zaltbommel 130 - Garden Fence
 H130xW180cm
 21 planks of D1.6xW14.0cm
 Intermediate slat: D1.6xW14.0cm
 Planed, impregnated pine,
 Stainless steel screwed



8.12090
Enschede 90 - Garden Fence
 H90xW180cm
 19 planks of D1.6xW14.0cm
 Intermediate slat: D1.6xW14.0cm
 Planed, impregnated pine,
 Stainless steel screwed



8.13090
Zaltbommel 90 - Garden Fence
 H90xW180cm
 21 planks of D1.6xW14.0cm
 Intermediate slat: D1.6xW14.0cm
 Planed, impregnated pine,
 Stainless steel screwed



8.12918
Enschede verloop - Garden Fence
 H180>90xW180cm
 19 planks of D1.6xW14.0cm
 Intermediate slat: D1.6xW14.0cm
 Planed, impregnated pine,
 Stainless steel screwed



8.13918
Zaltbommel verloop - Garden Fence
 H180>90xW180cm
 21 planks of D1.6xW14.0cm
 Intermediate slat: D1.6xW14.0cm
 Planed, impregnated pine,
 Stainless steel screwed



8.14194
Laren - Garden Fence
 H180xW180cm
 19 planks of D1.6xW14.0cm
 Intermediate slat: D1.6xW14.0cm
 Planed, impregnated pine,
 Stainless steel screwed





8.62180
Dordrecht 180 - Garden Fence
 H180xW180cm
 19 planks of D1.8xW14.5cm
 Intermediate slat: D1.8xW14.5cm
 Planed, impregnated,
 Northern Swedish spruce,
 Stainless steel screwed



8.61130
Azewijn 130 - Garden Fence
 H130xW180cm
 19 planks of D1.6xW14.5cm
 Intermediate slat: D1.6xW14.5cm
 Planed, impregnated
 Central European spruce,
 Stainless steel screwed



Cover slat, impregnated pine
 Planed, for straight screen



- 35.0918** Pyramid 180cm (2-plank clearance)
- 35.1018** Pyramid 180cm (3-plank clearance)
- 35.1024** Pyramid 240cm (3-plank clearance)



8.62150
Dordrecht 150 - Garden Fence
 H150xW180cm
 19 planks of D1.8xW14.5cm
 Intermediate slat: D1.8xW14.5cm
 Planed, impregnated,
 Northern Swedish spruce,
 Stainless steel screwed



8.62130
Dordrecht 130 - Garden Fence
 H130xW180cm
 19 planks of D1.8xW14.5cm
 Intermediate slat: D1.8xW14.5cm
 Planed, impregnated,
 Northern Swedish spruce,
 Stainless steel screwed



Cover slat, impregnated pine
 Planed, for straight and arched fences



- 35.0818** 183cm
- 35.0824** 240cm



8.62090
Dordrecht 90 - Garden Fence
 H90xW180cm
 19 planks of D1.8xW14.5cm
 Intermediate slat: D1.8xW14.5cm
 Planed, impregnated,
 Northern Swedish spruce,
 Stainless steel screwed



Cover slat, impregnated spruce
 Planed, for straight screen



- 35.2018** Rectangular 180cm (3-plank clearance)



8.62918
Dordrecht verloop - Garden Fence
 H180>90xW180cm
 19 planks of D1.8xW14.5cm
 Intermediate slat: D1.8xW14.5cm
 Planed, impregnated,
 Northern Swedish spruce,
 Stainless steel screwed



Cover slat, impregnated spruce
 Planed, for straight screen



- 35.3018** Pyramid 180cm (3-plank clearance)



8.61180
Azewijn 180 - Garden Fence
 H180xW180cm
 19 planks of D1.6xW14.5cm
 Intermediate slat: D1.6xW14.5cm
 Planed, impregnated
 Central European spruce,
 Stainless steel screwed





8.30180
Antwerpen - Garden Fence
 H180xW180cm
 15 planks of D1.6xW14.0cm
 Intermediate slat: D1.6xW14.0cm
 Planed, grey coated pine,
 Stainless steel screwed



8.31180
Luik - Garden Fence
 H180xW180cm
 17 planks of D1.6xW14.0cm
 Intermediate slat: D1.6xW14.0cm
 Planed, grey coated pine,
 Stainless steel screwed



8.32180
Brussel 180 - Garden Fence
 H180xW180cm
 19 planks of D1.6xW14.0cm
 Intermediate slat: D1.6xW14.0cm
 Planed, grey coated pine,
 Stainless steel screwed



8.33180
Gent 180 - Garden Fence
 H180xW180cm
 21 planks of D1.6xW14.0cm
 Intermediate slat: D1.6xW14.0cm
 Planed, grey coated pine,
 Stainless steel screwed



8.32150
Brussel 150 - Garden Fence
 H150xW180cm
 19 planks of D1.6xW14.0cm
 Intermediate slat: D1.6xW14.0cm
 Planed, grey coated pine,
 Stainless steel screwed



8.33150
Gent 150 - Garden Fence
 H150xW180cm
 21 planks of D1.6xW14.0cm
 Intermediate slat: D1.6xW14.0cm
 Planed, grey coated pine,
 Stainless steel screwed



8.32130
Brussel 130 - Garden Fence
 H130xW180cm
 19 planks of D1.6xW14.0cm
 Intermediate slat: D1.6xW14.0cm
 Planed, grey coated pine,
 Stainless steel screwed



8.33130
Gent 130 - Garden Fence
 H130xW180cm
 21 planks of D1.6xW14.0cm
 Intermediate slat: D1.6xW14.0cm
 Planed, grey coated pine,
 Stainless steel screwed



8.32090
Brussel 90 - Garden Fence
 H90xW180cm
 19 planks of D1.6xW14.0cm
 Intermediate slat: D1.6xW14.0cm
 Planed, grey coated pine,
 Stainless steel screwed



8.33090
Gent 90 - Garden Fence
 H90xW180cm
 21 planks of D1.6xW14.0cm
 Intermediate slat: D1.6xW14.0cm
 Planed, grey coated pine,
 Stainless steel screwed



8.32918
Brussel verloop - Garden Fence
 H180>90xW180cm
 19 planks of D1.6xW14.0cm
 Intermediate slat: D1.6xW14.0cm
 Planed, grey coated pine,
 Stainless steel screwed



8.33918
Gent verloop - Garden Fence
 H180>90xW180cm
 21 planks of D1.6xW14.0cm
 Intermediate slat: D1.6xW14.0cm
 Planed, grey coated pine,
 Stainless steel screwed





8.34180
Jack - Garden Fence
 H180xW180cm
 11 planks of D2.0xW20.0cm
 Intermediate slat: none
 Fitted with upper and lower slats
 Rough, grey coated pine,
 Stainless steel screwed



8.34182
Ellen - Garden Fence
 H180xW180cm
 19 planks of D1.7xW14.5cm
 Intermediate slat D1.7xW14.5cm
 Rough, grey coated pine,
 Stainless steel screwed



8.34181
Mark - Garden Fence
 H180xW180cm
 15 planks of D1.7xW14.5cm
 Intermediate slat D1.7xW14.5cm
 Rough, grey coated pine,
 Stainless steel screwed



35.10180G
Cover slat, coated grey
 Pyramid 180cm
 (3-plank clearance)
 Planed, for straight fences



8.34130
Rene - Garden Fence
 H130xW180cm
 19 planks of D1.7xW14.5cm
 Intermediate slat D1.7xW14.5cm
 Rough, grey coated pine,
 Stainless steel screwed



Galvanized U-profile ®
 For screens

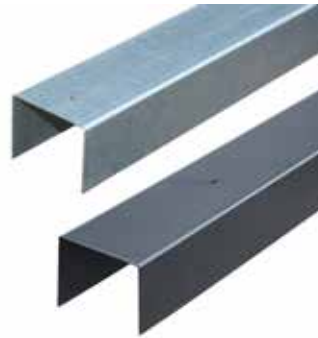

1.59151 Cover cap 50mm
1.59151Z Cover cap 50mm
 powder coated

*These specially
 developed
 products for
 Tuindecó are
 patented.*

New





8.20180
Zillertal - Garden Fence
 H180xW180cm
 15 planks of D1.6xW14.0cm
 Intermediate slat: D1.6xW14.0cm
 Planed, untreated
 larch/douglas,
 Stainless steel screwed



8.21180
Hamburg - Garden Fence
 H180xW180cm
 17 planks of D1.6xW14.0cm
 Intermediate slat: D1.6xW14.0cm
 Planed, untreated
 larch/douglas,
 Stainless steel screwed



8.22180
Zwarte Woud 180 - Garden Fence
 H180xW180cm
 19 planks of D1.6xW14.0cm
 Intermediate slat: D1.6xW14.0cm
 Planed, untreated
 larch/douglas,
 Stainless steel screwed



8.23180
Harz 180 - Garden Fence
 H180xW180cm
 21 planks of D1.6xW14.0cm
 Intermediate slat: D1.6xW14.0cm
 Planed, untreated
 larch/douglas,
 Stainless steel screwed



8.22150
Zwarte Woud 150 - Garden Fence
 H150xW180cm
 19 planks of D1.6xW14.0cm
 Intermediate slat: D1.6xW14.0cm
 Planed, untreated
 larch/douglas,
 Stainless steel screwed



8.23150
Harz 150 - Garden Fence
 H150xW180cm
 21 planks of D1.6xW14.0cm
 Intermediate slat: D1.6xW14.0cm
 Planed, untreated
 larch/douglas,
 Stainless steel screwed



8.22130
Zwarte Woud 130 - Garden Fence
 H130xW180cm
 19 planks of D1.6xW14.0cm
 Intermediate slat: D1.6xW14.0cm
 Planed, untreated
 larch/douglas,
 Stainless steel screwed



8.23130
Harz 130 - Garden Fence
 H130xW180cm
 21 planks of D1.6xW14.0cm
 Intermediate slat: D1.6xW14.0cm
 Planed, untreated
 larch/douglas,
 Stainless steel screwed



8.22090
Zwarte Woud 90 - Garden Fence
 H90xW180cm
 19 planks of D1.6xW14.0cm
 Intermediate slat: D1.6xW14.0cm
 Planed, untreated
 larch/douglas,
 Stainless steel screwed



8.23090
Harz 90 - Garden Fence
 H90xW180cm
 21 planks of D1.6xW14.0cm
 Intermediate slat: D1.6xW14.0cm
 Planed, untreated
 larch/douglas,
 Stainless steel screwed



8.22918
Zwarte Woud verloop - Garden Fence
 H180>90xW180cm
 19 planks of D1.6xW14.0cm
 Intermediate slat: D1.6xW14.0cm
 Planed, untreated
 larch/douglas,
 Stainless steel screwed



8.23918
Harz verloop - Garden Fence
 H180>90xW180cm
 21 planks of D1.6xW14.0cm
 Intermediate slat: D1.6xW14.0cm
 Planed, untreated
 larch/douglas,
 Stainless steel screwed





35.8018
Cover slat, larch/douglas
 Pyramid 180cm
 (3-plank clearance)
 Planed, untreated for straight
 screens



8.24186
Saksen - Garden Fence
 H180xW180cm
 11 planks of D1.8xW20.0cm
 Intermediate slat: none
 Fitted with upper and lower slats,
 planed, larch/douglas, Stainless
 steel screwed



8.24180
Winterberg - Garden Fence
 H180xW180cm
 15 planks of D1.6xW14.0cm
 Intermediate slat: D1.6xW14.0cm
 Rough, untreated
 larch/douglas,
 Stainless steel screwed



8.24182
Klagenfurt, rhombus fence
 H180xW180cm
 28 planks of D1.4xW5.8/6.9cm
 clings 4 lines: D1.6xW6.8cm
 Planed, untreated, larch/douglas,
 Stainless steel screwed



8.24185
Saarland, Garden fences
 H180xW180cm
 11 planks of D1.8xW20.0cm
 Intermediate slat: none
 Fitted with upper and lower slats
 Rough, larch/douglas,
 Stainless steel screwed



Larch/Douglas Rhombus slat
 Planed, dried, untreated



35.0918 1.6x4.3x180cm
35.1018 1.6x4.3x285cm
35.1024 1.6x4.3x385cm



8.24184
Innsbruck, Garden fence
 H180xW180cm
 17 planks of D1.6xW14.0cm
 Intermediate slat: D1.6xW14.0cm
 Rough, untreated
 larch/douglas,
 Stainless steel screwed



8.54180
Fulda - Garden Fence
 H180xW180cm
 21 planks D1.6xW14.0cm
 Intermediate slat: D1.6xW14.0cm
 Planed, black coated pine,
 Stainless steel screwed



8.51180
Koblenz - Garden Fence
 H180xW180cm
 17 planks D1.6xW14.0cm
 Intermediate slat: D1.6xW14.0cm
 Planed, black coated pine,
 Stainless steel screwed





8.52180
Stuttgart 180 - Garden Fence
 H180xW180cm
 19 planks of D1.6xW14.0cm
 Intermediate slat: D1.6xW14.0cm
 Planed, black coated pine,
 Stainless steel screwed



8.53180
Dresden 180 - Garden Fence
 H180xW180cm
 21 planks of D1.6xW14.0cm
 Intermediate slat: D1.6xW14.0cm
 Planed, black coated pine,
 Stainless steel screwed



8.52150
Stuttgart 150 - Garden Fence
 H150xW180cm
 19 planks of D1.6xW14.0cm
 Intermediate slat: D1.6xW14.0cm
 Planed, black coated pine,
 Stainless steel screwed



8.53150
Dresden 150 - Garden Fence
 H150xW180cm
 21 planks of D1.6xW14.0cm
 Intermediate slat: D1.6xW14.0cm
 Planed, black coated pine,
 Stainless steel screwed



8.52130
Stuttgart 130 - Garden Fence
 H130xW180cm
 19 planks of D1.6xW14.0cm
 Intermediate slat: D1.6xW14.0cm
 Planed, black coated pine,
 Stainless steel screwed



8.53130
Dresden 130 - Garden Fence
 H130xW180cm
 21 planks of D1.6xW14.0cm
 Intermediate slat: D1.6xW14.0cm
 Planed, black coated pine,
 Stainless steel screwed



8.52090
Stuttgart 90 - Garden Fence
 H90xW180cm
 19 planks of D1.6xW14.0cm
 Intermediate slat: D1.6xW14.0cm
 Planed, black coated pine,
 Stainless steel screwed



8.53090
Dresden 90 - Garden Fence
 H90xW180cm
 21 planks of D1.6xW14.0cm
 Intermediate slat: D1.6xW14.0cm
 Planed, black coated pine,
 Stainless steel screwed



8.52918
Stuttgart verloop - Garden Fence
 H180>90xW180cm
 19 planks of D1.6xW14.0cm
 Intermediate slat: D1.6xW14.0cm
 Planed, black coated pine,
 Stainless steel screwed



8.53918
Dresden verloop - Garden Fence
 H180>90xW180cm
 21 planks of D1.6xW14.0cm
 Intermediate slat: D1.6xW14.0cm
 Planed, black coated pine,
 Stainless steel screwed



8.50180
Hamburg - Garden Fence
 H180xW180cm
 15 planks of D1.6xW14.0cm
 Intermediate slat: D1.6xW14.0cm
 Planed, black coated pine,
 Stainless steel screwed



35.1018ZW
Cover slat, black coated
 Pyramid 180cm
 (3-plank clearance)
 Planed, for straight screen





8.42180
Dronten 180 - Garden Fence
 H180xW180cm
 19 planks of D1.4xW14.0cm
 Intermediate slat: D1.4xW14.0cm
 Front 2 V-grooves
 Planed, hardwood,
 Stainless steel screwed



8.43180
Hoorn 180 - Garden Fence
 H180xW180cm
 21 planks of D1.4xW14.0cm
 Intermediate slat: D1.4xW14.0cm
 Front 2 V-grooves
 Planed, hardwood,
 Stainless steel screwed



8.42150
Dronten 150 - Garden Fence
 H150xW180cm
 19 planks of D1.4xW14.0cm
 Intermediate slat: D1.4xW14.0cm
 Front 2 V-grooves
 Planed, hardwood,
 Stainless steel screwed



8.43150
Hoorn 150 - Garden Fence
 H150xW180cm
 21 planks of D1.4xW14.0cm
 Intermediate slat: D1.4xW14.0cm
 Front 2 V-grooves
 Planed, hardwood,
 Stainless steel screwed



8.42130
Dronten 130 - Garden Fence
 H130xW180cm
 19 planks of D1.4xW14.0cm
 Intermediate slat: D1.4xW14.0cm
 Front 2 V-grooves
 Planed, hardwood,
 Stainless steel screwed



8.43130
Hoorn 130 - Garden Fence
 H130xW180cm
 21 planks of D1.4xW14.0cm
 Intermediate slat: D1.4xW14.0cm
 Front 2 V-grooves
 Planed, hardwood,
 Stainless steel screwed



8.42090
Dronten 90 - Garden Fence
 H90xW180cm
 19 planks of D1.4xW14.0cm
 Intermediate slat: D1.4xW14.0cm
 Front 2 V-grooves
 Planed, hardwood,
 Stainless steel screwed



8.43090
Hoorn 90 - Garden Fence
 H90xW180cm
 21 planks of D1.4xW14.0cm
 Intermediate slat: D1.4xW14.0cm
 Front 2 V-grooves
 Planed, hardwood,
 Stainless steel screwed



8.42918
Dronten verloop - Garden Fence
 H180>90xW180cm
 19 planks of D1.4xW14.0cm
 Intermediate slat: D1.4xW14.0cm
 Front 2 V-grooves
 Planed, hardwood,
 Stainless steel screwed



8.43918
Hoorn verloop - Garden Fence
 H180>90xW180cm
 21 planks of D1.4xW14.0cm
 Intermediate slat: D1.4xW14.0cm
 Front 2 V-grooves
 Planed, hardwood,
 Stainless steel screwed



8.40180
Kampen 180 - Garden Fence
 H180xW180cm
 15 planks of D1.4xW14.0cm
 Intermediate slat: D1.4xW14.0cm
 Front 2 V-grooves
 Planed, hardwood,
 Stainless steel screwed



8.40090
Kampen 90 - Garden Fence
 H90xW180cm
 15 planks of D1.4xW14.0cm
 Intermediate slat: D1.4xW14.0cm
 Front 2 V-grooves
 Planed, hardwood,
 Stainless steel screwed





8.44180
Leeuwarden 180 - Garden Fence
 H180xW180cm
 23 planks of D1.2xW9.0cm
 Intermediate slat: D1.5xW7.0cm
 Relief plank, hardwood,
 Stainless steel screwed



8.45180
Makkum, rhombus fence
 H180xW180cm
 26 planks of D1.4xW5.8/6.9cm
 Clings 4 lines: D1.6xW6.8cm
 Planed, hardwood,
 Stainless steel screwed



8.44090
Leeuwarden 90 / Garden Fence
 H90xW180cm
 23 planks of D1.2xW9.0cm
 Intermediate slat: D1.5xW7.0cm
 Relief plank, hardwood,
 Stainless steel screwed



35.9018
Cover slat, hardwood
 Pyramid 180cm
 (3-plank clearance)
 Planed, for straight fences



8.41180
Harlingen - Garden Fence
 H180xW180cm
 17 planks of D1.4xW14.0cm
 Intermediate slat: D1.4xW14.0cm
 Front 2 V-grooves
 Planed, hardwood,
 Stainless steel screwed



35.9818
Cover slat, hardwood
 183cm
 Planed, for both straight and arched fences



Fence supports



- 39.0003** Stainless steel
30x30mm
(per item)
- 39.0002** Yellow-galvanised
30x30mm
(per item)
- 39.0001** Yellow-galvanised
30x30mm
(per pack of 12)
Screws included

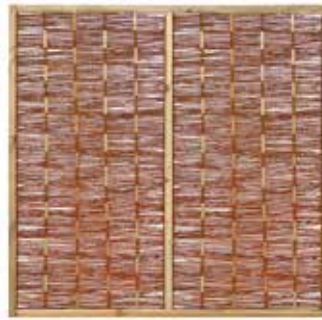

8.35180
Willow Garden Fence
H180xW180cm
Frame: D3.0xW4.5cm
Planed, impregnated pine



L-bracket



- 39.0005** 30x30mm
- 39.0006** 40x40mm



8.35090
Willow Garden Fence
H90xW180cm
Frame: D3.0xW4.5cm
Planed, impregnated pine



Quarter circle, two-sided
Bar: 1.6cm
Planed, impregnated pine



- 12.2150** 1/4Ø 150cm
- 12.2180** 1/4Ø 170cm



8.14187
Rustiek - Garden Fence
H180xW180cm
13 planks of D1.8xW20.0-25.0cm
Intermediate slat: D1.6xW7.0cm
Rough, impregnated pine,
Stainless steel screwed



8.71515
Garden fence chestnut
H150xW150cm





GARDEN FENCE ENSCHEDE 180 ARCH



GARDEN FENCE ZWARTE WOOD 180 SUPERIOR STRAIGHT



GARDEN FENCE ENSCHEDE 180 SUPERIOR ARCH



GARDEN FENCE DRONTEN 180 ARCH

GARDEN FENCE SUPERIOR AND ARCH

A large number of screens are also available in a counter and / or superior variant. Superior means that an inset frame, as shown on this page, is mounted in the screen. Above you will see four variants.

The insert frames are also available separately for handy do-it-yourselfers.



8.41111
Frame for straight fence,
impregnated pine
H80xW160cm
Thickness: 4.8cm
(3 planks of 1.6cm)



8.71111
Hardwood frame for straight
fence
H80xW160cm
Thickness: 4.2cm
(3 planks of 1.4cm)



8.51111
Frame for straight fence,
larch/ douglas
H80xW160cm
Thickness: 4.8cm
(3 planks of 1.6cm)



New



8.42222
Frame for arched fence,
impregnated pine
H80xW138cm
Thickness: 4.8cm
(3 planks of 1.6cm)



8.72222
Hardwood frame for arched
fence
H80xW148cm
Thickness: 4.2cm
(3 planks of 1.4cm)



Superieur and/or arch variant

- 8.10180RS** Coevorden 180 Superior - Garden Fence, straight
- 8.10150RS** Coevorden 150 Superior - Garden Fence, straight
- 8.10180TO** Coevorden 180 - Garden Fence, arch
- 8.10150TO** Coevorden 150 - Garden Fence, arch
- 8.10180TS** Coevorden 180 Superior- Garden Fence, arch
- 8.10150TS** Coevorden 180 Superior- Garden Fence, arch

- 8.11180RS** Vasse 180 Superior - Garden Fence, straight
- 8.11150RS** Vasse 150 Superior - Garden Fence, straight
- 8.11180TO** Vasse 180 - Garden Fence, arch
- 8.11150TO** Vasse 150 - Garden Fence, arch
- 8.11180TS** Vasse 180 Superior - Garden Fence, arch
- 8.11150TS** Vasse 150 Superior - Garden Fence, arch

- 8.12180RS** Enschede 180 Superior - Garden Fence, straight
- 8.12150RS** Enschede 150 Superior - Garden Fence, straight
- 8.12180TO** Enschede 180 - Garden Fence, arch

- 8.12150TO** Enschede 150 - Garden Fence, arch
- 8.12180TS** Enschede 180 Superior - Garden Fence, arch
- 8.12150TS** Enschede 150 Superior - Garden Fence, arch

- 8.42180RS** Dronten 180 Superior - Garden Fence, straight
- 8.42180TO** Dronten 180 - Garden Fence, arch
- 8.42180TS** Dronten 180 Superior - Garden Fence, arch

- 8.40180RS** Kampen 180 Superior - Garden Fence, straight
- 8.40180TO** Kampen 180 - Garden Fence, arch
- 8.40180TS** Kampen 180 Superior - Garden Fence, arch



FLEX FENCE

Adjustable, decorative and durable
The decorative Flex Fence has a wonderfully unique feature. By simply rotating the bars you can choose the amount of privacy or shade that you want.

You can use the Flex Fence system as fencing or a partition wall but also as a roof on a pergola for example.

You can adjust and adapt the Flex Fence to any desired dimensions.



8.99180

Stainless Steel DIY Pack Flex Fence 165cm

The DIY pack consists of pre-assembled upper and lower rail. It's your own creativity that determines the ultimate, unique result!

Example 1:

Do you want to construct a Flex Fence from impregnated wood with the dimensions 180x180cm?

Do you want to place it **vertically** and give it a wooden border?

Required:

Stainless steel DIY Flex Fence

14 planks 1.9x14.5x180cm

Wooden border, 4 pieces 4.4x7.0x180cm

Example 2:

Do you want to make a Flex Fence of hardwood with the dimensions 90x180cm? Do you want to place it **horizontally** and give it a wooden border and horizontal planks?

Required:

Stainless steel DIY Flex Fence

6 planks 1.4x14.0x180cm

Wooden border, 2 pieces 4.4x6.8x305cm





11.0100
Aalsmeer - Garden gate
 H180xW100cm
 11 planks of D1.0xW10.0cm
 Rough, impregnated pine, stapled



11.0102
Ermelo - Garden gate
 H180xW100cm
 11 planks of D1.0xW10.0cm
 Rough, impregnated pine, stapled



11.0700
Erica - Garden gate
 H180xW100cm
 15 planks of D1.6xW14.0cm
 Planed, impregnated pine, Stainless steel screwed



11.0200
Hoogeveen - Garden gate
 H180xW100cm
 9 planks of D1.6xW14.0cm
 Planed, impregnated pine, Stainless steel screwed



11.1110
Heerenveen - Garden gate with stainless steel lock
 H180xW100cm
 2-sided Timber cladding elements of D1.8xW14.5cm
 Planed, impregnated pine, screwed



11.1301
End plank, impregnated pine for solid door
 D1.6xW8.5xH180cm
 Supplied complete with cylinder lock and 2 keys



11.1330
Petten - Garden gate with stainless steel lock
Fitted with iron frame
 H200xW100cm
 2-sided Timber cladding elements of D1.8xW14.5cm
 Planed, impregnated Swedish spruce timber cladding, screwed, right-hinged



11.1335
Schoorl - Garden gate with stainless steel lock
Fitted with iron frame
 H200xW100cm
 2-sided Timber cladding elements of D1.8xW14.5cm
 Planed, impregnated Swedish timber cladding, screwed



1.59009
Garden Gate Frame + Stop Beam
 Impregnated pine
 H210xW90>150cm
 Beams D4.4xW8.8cm

Solide - Garden gate (fitted with iron frame)
 Planks of D1.6xW14.0cm
 Planed, impregnated pine, screwed



11.1309 H180xW90cm
11.1310 H180xW100cm
11.1311 H180xW110cm
11.1312 H180xW120cm

Privacy - Garden gate with stainless steel lock (fitted with iron frame)
 Planks of D1.6xW14.0cm
 Planed, impregnated pine, screwed



11.1319 H195xW90cm
11.1320 H195xW100cm
11.1321 H195xW110cm
11.1322 H195xW120cm
11.1323 H195xW130cm
11.1324 H195xW140cm
11.1325 H195xW150cm



11.1350
Solide - Garden gate
 H180xW100cm
 (fitted with iron frame)
 9 planks of D1.4xW14.0cm
 Front 2 V-grooves
 Planed, hardwood,
 screwed



Privacy - Garden gate with stainless steel lock (fitted with iron frame)

Planks of D1.4xW14.0cm
 Front 2 V-grooves
 Planed, hardwood, screwed



- 11.1369** H195xW90cm
- 11.1370** H195xW100cm
- 11.1371** H195xW110cm
- 11.1372** H195xW120cm
- 11.1373** H195xW130cm
- 11.1374** H195xW140cm
- 11.1375** H195xW150cm



11.1200
Kampen - Garden gate
 H180xW100cm
 9 planks of D1.4xW14.0cm
 Front 2 V-grooves
 Planed, hardwood,
 Stainless steel screwed



Privacy - Garden gate with stainless steel lock (fitted with iron frame)

Planks of D1.6xW14.0cm
 Planed, larch/douglas, screwed



- 11.1384** H195xW90cm
- 11.1385** H195xW100cm
- 11.1387** H195xW120cm



11.1000
Leeuwarden - Garden gate
 H180xW100cm
 13 planks of D1.2xW9.0cm
 Relief plank, hardwood,
 Stainless steel screwed



Privacy - Garden gate with stainless steel lock (fitted with iron frame)

Planks of D1.6xW14.0cm
 Planed, grey coated pine, screwed



- 11.1359** H195xW90cm
- 11.1360** H195xW100cm
- 11.1362** H195xW120cm



11.1351
End plank, hardwood for Solide door
 D1.4xW8.5xH180cm
 Supplied complete with
 cylinder lock and 2 keys



Privacy - Garden gate with stainless steel lock (fitted with iron frame)

Planks of D1.6xW14.0cm
 Planed, black coated pine, screwed



- 11.1389** H195xW90cm
- 11.1390** H195xW100cm
- 11.1392** H195xW120cm



1.59010
Garden Gate Frame + Stop Beam
 H210xW90>150cm
 Beams D4.4xW8.8cm
 Hardwood

Iron gate frame

For making a garden gate oneself

The planks can be mounted onto the frame using drill screws.

Number of required spiggots: up to 110cm wide, 2 items, as of 120cm wide, 3 items.



- 11.5080** H80xW100cm
- 11.5090** H155xW90cm
- 11.5100** H155xW100cm
- 11.5110** H155xW110cm
- 11.5120** H155xW120cm
- 11.5130** H155xW130cm
- 11.5140** H155xW140cm
- 11.5150** H155xW150cm
- 11.5200** H155xW200cm



39.0210
Spigot 38.0x5.0mm
Per item

Iron gate frame with lock casing

For making a garden gate oneself

The planks can be mounted onto the frame using drill screws.



- 11.5500** H155xW100cm
Number of required spiggots: 2 items
- 11.5501** H200xW100cm
Number of required spiggots: 3 items



39.0211
Spigot adjustable
Per item



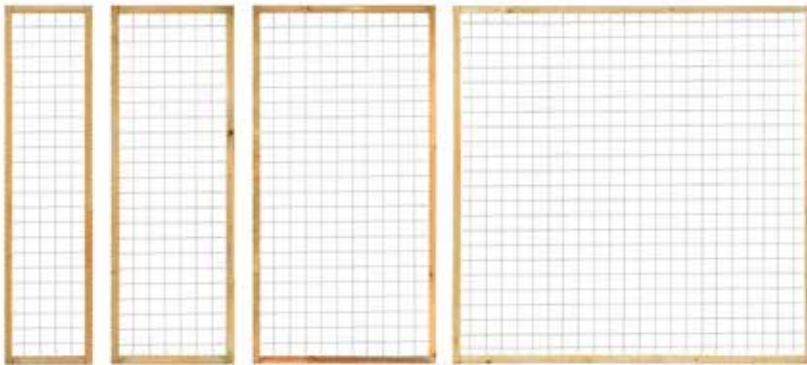

Meshed Elements with an impregnated wooden frame

Frame thickness: 4.5x4.5cm

Mesh width: 7.5x7.5cm

Mesh: 3.8mm, galvanised

15.2040 Meshed element with an impregnated wooden frame H180xW45cm

15.2060 Meshed element with an impregnated wooden frame H180xW60cm

15.2090 Meshed element with an impregnated wooden frame H180xW90cm

15.2180 Meshed element with an impregnated wooden frame H180xW180cm

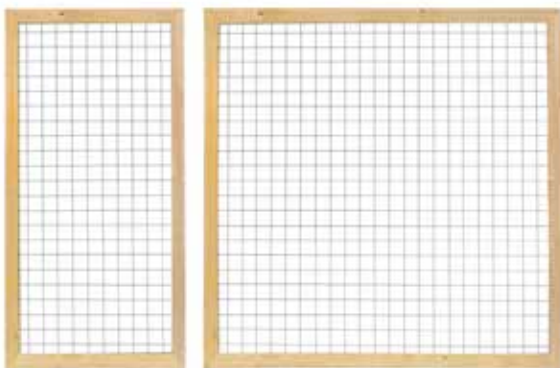

Meshed Elements with an impregnated wooden frame

Frame thickness: 4.5x7.0cm

Mesh width: 7.5x7.5cm

Mesh: 3.8mm, galvanised

15.3090 Meshed element with an impregnated wooden frame H180xW90cm

15.3180 Meshed element with an impregnated wooden frame H180xW180cm

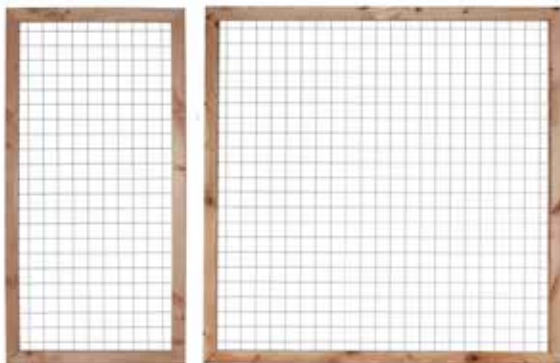

Meshed elements with larch/douglas wooden frame

Frame thickness: 4.5x7.0cm

Mesh width: 7.5x7.5cm

Mesh: 3.8mm, galvanised

15.4090 Meshed element with larch/douglas wooden frame H180xW90cm

15.4180 Meshed element with larch/douglas wooden frame H180xW180cm

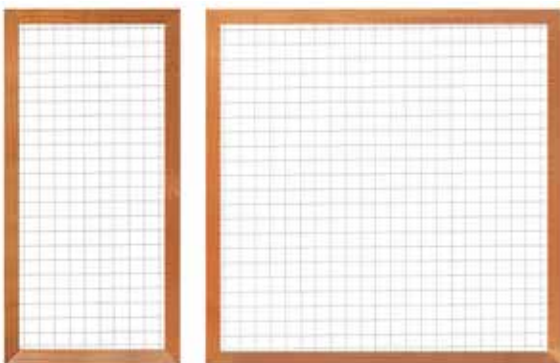

Meshed Elements with a hardwood frame

Frame thickness: 4.4x6.8cm

Mesh width: 7.5x7.5cm

Mesh: 3.8mm, galvanised

15.3509 Meshed element with a hardwood frame H180xW90cm

15.3518 Meshed element with a hardwood frame H180xW180cm



Meshed element and accessoires

Mesh width: 7.5x7.5cm

Mesh thickness: 3.8mm, galvanised

Fully sealed

15.2041 Meshed element W38xH173cm

15.2061 Meshed element W53xH173cm

15.2091 Meshed element W83xH173cm

15.2181 Meshed element W173xH173cm

Mesh width: 10.0x10.0cm

Mesh thickness: 3.4mm, galvanised

Fully sealed

15.3280 Meshed element W180xH180cm

15.2001 Fitting Kit for meshed element, galvanised Set of 4

15.2003 Fitting kit for meshed element, stainless steel Set of 4



Trellis straight

Bar: 1.3x2.5cm

Impregnated pine

15.0300 W30xH180cm

15.0600 W60xH180cm

15.6180 W180xH180cm

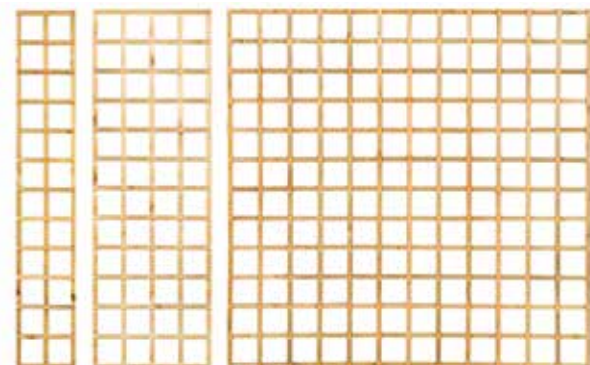

Trellis straight with straight frame

Bar: 1.3x4.0cm

Frame thickness: 4.5x4.5cm

Impregnated pine

15.2400 W40xH180cm

15.3600 W60xH180cm

15.1018 W180xH180cm

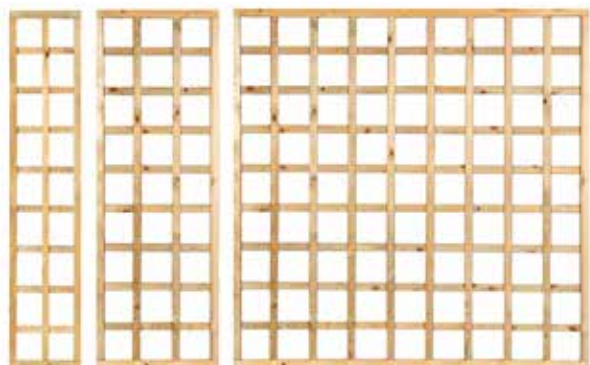

Trellis diagonal with straight frame

Bar: 1.3x4.0cm

Frame thickness: 4.5x4.5cm

Impregnated pine

15.4400 W40xH180cm

15.5600 W60xH180cm

15.5900 W90xH180cm

15.1019 W180xH180cm

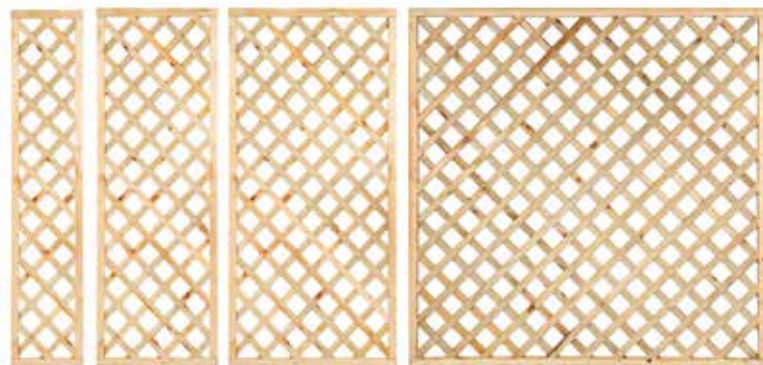

Trellis diagonal with arched/concave frame

Bar: 1.3x4.0cm

Frame thickness: 4.5x4.5cm

Impregnated pine

15.1218 W180xH180cm with arched frame

15.1318 W180xH60cm with arched frame

15.1718 W180xH40cm with concave frame



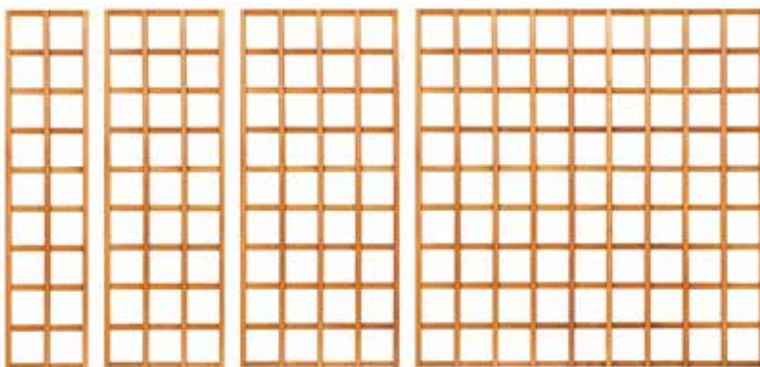

Trellis straight, hardwood
Bar: 1.4x3.0cm

- 15.9045** W40xH180cm
- 15.9060** W60xH180cm
- 15.9090** W90xH180cm
- 15.9180** W180xH180cm

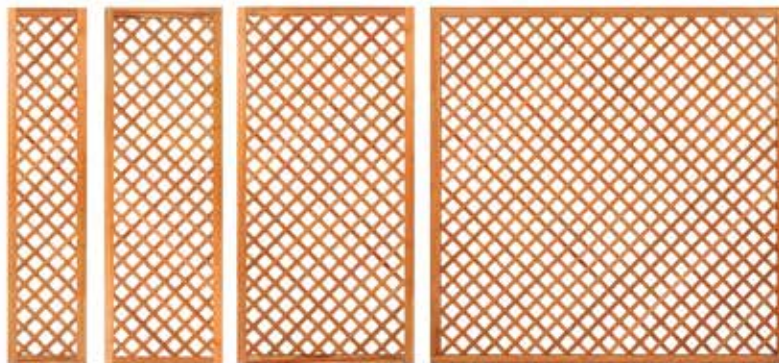

Trellis diagonal with hardwood frame
Bar: 0.7x2.0cm
Frame thickness: 3.0x5.0cm

- 15.8045** W40xH180cm
- 15.8060** W60xH180cm
- 15.8090** W90xH180cm
- 15.8180** W180xH180cm



NATURAL FENCES, GRAVEL AND GRIT

A natural fence consists of 9cm wide hardwood posts, onto which galvanised mesh panels are mounted with a mesh width of 4.5x4.5cm. This gives you segments of a maximum of 90x180cm. In order to prevent the mesh panels from sagging you can use stainless steel mesh ties. It is important to lay a solid foundation in order to prevent the mesh contents from washing away. For laying a garden path you can use, for example, gravel or grit. Available in various sizes and varieties. Packaging in big-bags of 1000kg with which you can cover approx. 12-15m² of the ground surface (with a layer of 3-5cm).



44.1030
Fench tree bark >45mm
 Bag of 70L



44.0032
Yellow sun 45-70mm
 Big-bag of ± 1000kg



44.0033
Ardennes grey 45-80mm
 Big-bag of ± 1000kg



44.0037
Grauwacke 60-80mm
 Big-bag of ± 1000kg



44.0031
White ornamental gravel 40-80mm
 Big-bag of ± 1000kg



2.51030
Hardwood girder 4.0x9.0x300cm
 Sharp-edged and fine sawn
 This can also be used as a foundation girder.



44.0035
Basalt black 56-75mm
 Big-bag of ± 1000kg



15.5190
Meshed element
 Dimensions: H180xW90cm
 Mesh width: 4.5x4.5cm
 Mesh thickness: 4.8mm, galvanised
 Fully sealed



44.0034
Porphyry red 50-80mm
 Big-bag of ± 1000kg



15.2002
Mesh ties 9cm, stainless steel
 Set of 6 pcs



DIY Panniers

15.7001 Meshed element, 100x200cm

15.7002 Meshed element 30x200cm

Mesh width: 4.5x4.5cm

Mesh: 5mm, galvanised

15.7005 Iron tube for anchoring
high gabions Ø3.4x300cm

Fittings

49.0050 Ring tongs with automatic transport

49.0051 Ring tong rings 20mm galvanised
1000 rings in a box
(insert ring every 10cm)

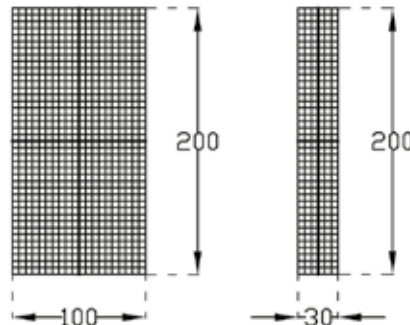

Tips:

- In order to prevent sagging, always assemble intermediate boards every 40cm (these you can make yourself from the same mesh as the product itself).
- By placing several intermediate boards you can also create a partition containing a variety of coloured fillings in a single design.
- We recommend one ring every 10cm.
- For each design higher than 75cm or wider than 25cm, we recommend iron tubes as a means of reinforcement.
- The iron tubes are placed within the construction and later hidden from view by filling it up.
- After the grinding, the open edges must be treated with a zinc-based coating to prevent corrosion.
- As a rule, products made from mesh and stone are heavy. Make sure that you lay a foundation of concrete, tiles or hardwood to prevent sinking.
- The meshed elements are double-wired, both horizontally and vertically at the centre in order to prevent the 'loss' of mesh.



Decorative reed mat

These decorative reed mats are 600cm long and are single-bound.

- 8.30010** Height 100cm
- 8.30020** Height 120cm
- 8.30030** Height 140cm
- 8.30040** Height 160cm
- 8.30050** Height 180cm
- 8.30060** Height 200cm



Decorative reed mat

These decorative reed mats are 200cm long and are double-bound. This mat has several reed stems in a single loop.

- 8.30070** Height 100cm
- 8.30080** Height 125cm
- 8.30090** Height 150cm
- 8.30100** Height 175cm
- 8.30110** Height 200cm



Reed screen, thickness 25 mm

These reed screens are bound with iron mesh and are 200cm long.

- 8.30120** Height 100cm
- 8.30130** Height 125cm
- 8.30140** Height 150cm
- 8.30150** Height 175cm
- 8.30160** Height 200cm



Heather mat

These heather mats are bound with iron mesh and are 500cm long.

- 8.31001** Height 100cm
- 8.31002** Height 150cm
- 8.31004** Height 175cm
- 8.31005** Height 200cm



Willow mat

Each willow mat has separately bound stems and has a length of 200cm.

- 8.35100** Height 100cm
- 8.35150** Height 150cm
- 8.35175** Height 175cm
- 8.35200** Height 200cm





English chestnut fencing on roll

- 8.70090** L460xH90cm slat distance 7.5cm, 2 wires
- 8.71090** L460xH90cm slat distance 5.0cm, 2 wires
- 8.70105** L460xH105cm slat distance 7.5cm, 2 wires
- 8.72105** L460xH105cm slat distance 7.5cm, 3 wires
- 8.71105** L460xH100cm slat distance 5.0cm, 3 wires
- 8.70120** L460xH120cm slat distance 7.5cm, 2 wires
- 8.72120** L460xH120cm slat distance 7.5cm, 3 wires
- 8.71120** L460xH120cm slat distance 5.0cm, 3 wires
- 8.70180** L460xH180cm slat distance 5.0cm, 3 wires



Chestnut gate / chestnut posts

- 8.60100** Chestnut gate W120xH100cm including 2 chestnut posts and fitting kit
- 8.60120** Chestnut gate W120xH120cm including 2 chestnut posts and fitting kit
- 8.81016** Ø7-9xL150cm peeled and thinly pointed
- 8.81018** Ø7-9xL175cm peeled and thinly pointed
- 8.81017** Ø8-10xL175cm peeled and thinly pointed
- 8.81025** Ø7-9xL250cm peeled and thinly pointed





9.30400
Econoom - Garden Fence
 H40xW150cm
 Bar thickness: 1.6cm
 Relief plank, impregnated pine



Garden Fence, Straight
9.00600 H60xW180cm
9.00800 H80xW180cm
9.01000 H100xW180cm
 Bar: 1.6x9.0cm
 Planed with rounded angles,
 impregnated pine



Garden Fence, Arch
9.00650 H60xW180cm
9.00850 H80xW180cm
9.01050 H100xW180cm
 Bar: 1.6x9.0cm
 Planed with rounded angles,
 impregnated pine



Garden Fence Gate, Straight
10.0600 H60xW100cm
10.0800 H80xW100cm
10.1000 H100xW100cm
 Bar: 1.6x9.0cm
 Planed with rounded
 corners, impregnated pine



**Garden Fence, Hardwood,
 Straight**
10.2000 H60xW100cm
10.2100 H90xW100cm
 Bar: 1.6x7.0cm
 Planed, stainless steel screwed



**Garden Fence, Hardwood,
 Straight**
9.25000 H60xW180cm
9.27000 H90xW180cm
 Bar: 1.6x7.0cm
 Planed, stainless steel screwed



Garden Fence, Hardwood, Arch
9.26000 H60xW180cm
9.28000 H90xW180cm
 Bar: 1.6x7.0cm
 Planed, stainless steel screwed





10.1300 Driveway gate
 H120xW360cm (2x180cm)
 Thickness: 7.0cm
 Pin-hole connection, glued,
 impregnated pine

**39.0222 Hinges and locks
 for driveway gate**
 Complete set for both parts



**8.80180
 Rustic entrance gate**
 H120xW180cm
 Thickness: 6.5cm
 Planed, impregnated pine



9.22000 Garden fence De Luxe
 H80xW180cm
10.1100 Garden fence gate De Luxe
 H80xW100cm
 Thickness: 4.0cm
 Pin-hole connection, glued,
 laminated and dried, impregnated
 pine



10.1200 Entrance gate De Luxe
 H80>100xW150cm
 Thickness: 4.0cm
 Pin-hole connection, glued, laminated and
 dried, impregnated pine

**39.0221
 Set blackline de Luxe**
 Suitable for garden fence gate
 and entrance gate De Luxe
 Including 1 40cm hinge and 1 60cm hinge
 Complete set for 1 part

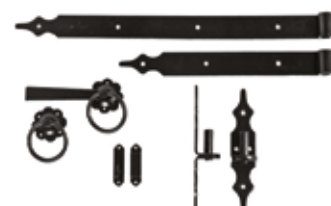



9.40700 Perfect - Garden Fence

H70xW280cm
Thickness: 4.5cm

**35.7650
Cover Slat for Garden Fence
Perfect**

H4.5xW13.5xL280cm
Planed, dried, untreated larch



With these specially designed glass clamps, the applications are endless, using every post from our product range.

Have you thought about Glass Fencing as a partition or a wall in your veranda or garden? The effect is stunning.

You can easily order tempered made-to-measure safety glass from your local retailer.



**39.0040
Glass Clamp Stainless Steel 316**
Suitable for 6mm (tempered) glass





For DIY enthusiasts we have a wide range of garden timber from posts to planks in various kinds of wood and sizes that can fit in with your garden design.

For hardware, screws, post support, concrete pad footings and pile ornaments see pages 37, 411 and 414 to 416

Post, Central European impregnated pinewood



	1.71800	6.8x6.8x180cm
	1.72000	6.8x6.8x200cm
	1.72400	6.8x6.8x240cm
	1.72700	6.8x6.8x270cm
	1.73000	6.8x6.8x300cm
	1.74000	6.8x6.8x400cm
	1.92000	8.8x8.8x200cm
	1.92400	8.8x8.8x240cm
	1.92700	8.8x8.8x270cm
	1.93000	8.8x8.8x300cm
	1.94000	8.8x8.8x400cm
	1.12300	12.0x12.0x300cm
	1.12400	12.0x12.0x400cm

Hardwood post with pointed end
4-sided planed with 2 V-grooves



	1.65100	6.5x6.5x100cm
	1.65150	6.5x6.5x150cm
	1.65270	6.5x6.5x275cm
	1.65300	6.5x6.5x300cm
	1.69131	8.5x8.5x135cm
	1.69271	8.5x8.5x275cm
	1.69301	8.5x8.5x300cm
	1.69391	8.5x8.5x400cm

Post, Central European impregnated pinewood with pointed end



	1.71000	6.8x6.8x100cm
	1.71500	6.8x6.8x150cm
	1.91000	8.8x8.8x100cm
	1.91500	8.8x8.8x150cm

Hardwood post
Fine sawn



	1.40060	4.0x4.0x60cm
	1.40150	4.0x4.0x150cm
	1.60075	6.0x6.0x75cm
	1.60100	6.0x6.0x100cm
	1.60150	6.0x6.0x150cm
		60-150cm has a pointed end
	1.60200	6.0x6.0x200cm
	1.60275	6.0x6.0x275cm
	1.60300	6.0x6.0x300cm
	1.70275	7.0x7.0x275cm
	1.70300	7.0x7.0x300cm

Post, larch/douglas

Unplaned, fresh sawn, core-free, undried, top quality and untreated



	45.0930	9.0x9.0x300cm
	45.1225	12.0x12.0x250cm
	45.1230	12.0x12.0x300cm
	45.1240	12.0x12.0x400cm
	45.1250	12.0x12.0x500cm
	45.1525	15.0x15.0x250cm
	45.1530	15.0x15.0x300cm
	45.1540	15.0x15.0x400cm
	45.1550	15.0x15.0x500cm
	45.1560	15.0x15.0x600cm
	45.2025	20.0x20.0x250cm
	45.2030	20.0x20.0x300cm
	45.2040	20.0x20.0x400cm
	45.2050	20.0x20.0x500cm

Post, larch/douglas

Planed, dried, core-free, top quality and untreated



	45.6530	6.5x6.5x300cm
	45.8530	8.5x8.5x300cm
	45.8060	11.5x11.5x300cm
	45.8061	11.5x11.5x400cm
	45.8013	14.5x14.5x250cm
	45.8003	14.5x14.5x300cm
	45.8004	14.5x14.5x400cm

Post, Northern Swedish impregnated spruce

Planed, rounded angles and artificially dried

**1.13300** 13.8x13.8x300cm**Slat, Northern Swedish impregnated spruce**

Planed, rounded angles and artificially dried

2.05236 1.9x4.5x360cm
2.05239 1.9x4.5x390cm
2.05242 1.9x4.5x420cm
2.07236 1.9x7.0x360cm
2.07239 1.9x7.0x390cm
2.07242 1.9x7.0x420cm
Plank, Central European impregnated pinewood

Planed with rounded angles

19.1418 1.6x4.5x180cm
19.0180 1.6x7.0x180cm
19.0210 1.6x7.0x210cm
19.0400 1.6x7.0x400cm
19.2818 2.8x7.0x180cm
19.2840 2.8x7.0x400cm
2.03418 2.8x3.6x180cm
Girder, Northern Swedish impregnated spruce

Planed, rounded angles and artificially dried

2.07424 4.4x7.0x240cm
2.07427 4.4x7.0x270cm
2.07430 4.4x7.0x300cm
2.07436 4.4x7.0x360cm
2.07439 4.4x7.0x390cm
2.07442 4.4x7.0x420cm
2.07445 4.4x7.0x450cm
2.07451 4.4x7.0x510cm
2.07454 4.4x7.0x540cm
2.10427 4.5x9.5x270cm
2.10430 4.5x9.5x300cm
2.10436 4.5x9.5x360cm
2.10439 4.5x9.5x390cm
2.10442 4.5x9.5x420cm
2.10451 4.5x9.5x510cm
2.15530 4.5x14.5x300cm
2.15536 4.5x14.5x360cm
2.15539 4.5x14.5x390cm
2.15542 4.5x14.5x420cm
2.15545 4.5x14.5x450cm
2.15551 4.5x14.5x510cm
2.197401 7.0x19.5x400cm
2.197501 7.0x19.5x500cm
OAK

Oak is one of the most widely used and best known types of wood. The colour differences in the wood, the cracks on the ends, the knots and other features give oak that beloved rugged and rustic look.

Oak needs time to age, work and dry out. As oak is sawn while wet, there is still tannin in the heart of the wood. This may lead to brown or black stripes in the oak. This only happens initially after having been placed but will gradually disappear. This is just a feature of oak.

Post, oak

Unplaned, fresh sawn, undried, top quality and untreated.

**47.1530** 15.0x15.0x300cm**Girder, oak**

Unplaned, fresh sawn, undried, top quality and untreated.

47.5154 5.0x15.0x400cm
47.5155 5.0x15.0x500cm
47.0724 7.0x20.0x400cm
47.0725 7.0x20.0x500cm

Hardwood timber

Widest side 2x V-groove, rounded angles



2.45730	4.4x6.8x305cm
2.45739	4.4x6.8x400cm
2.45742	4.4x6.8x430cm
2.45930	4.4x8.8x305cm
2.45939	4.4x8.8x400cm
2.45942	4.4x8.8x430cm
2.51430	4.4x14.5x305cm
2.51439	4.4x14.5x400cm
2.51442	4.4x14.5x430cm
2.51448	4.4x14.5x490cm

Slat, hardwood

Planed with rounded angles



2.46167	1.6x7.0x180cm
2.46168	1.6x7.0x210cm

Hardwood timber

Planed, relief, rounded angles



2.46110	1.2x9.0x180cm
---------	---------------

Hardwood girder

Sharp-edged and fine sawn

This can also be used as a foundation girder.



2.51030	4.0x9.0x300cm
2.41930	4.0x20.0x300cm
2.41940	4.0x20.0x400cm
2.41950	4.0x20.0x500cm

Girder, larch/douglas

Planed, dried, core-free, top quality, rounded angles and untreated



45.8045	4.0x6.0x300cm
45.8046	4.0x6.0x400cm
45.8042	4.5x7.0x300cm
45.8040	4.5x7.0x400cm
45.8041	4.5x7.0x500cm
45.8050	4.5x9.0x400cm
45.8051	4.5x9.0x500cm
45.8001	4.5x14.5x300cm
45.8002	4.5x14.5x400cm
45.8010	4.5x14.5x500cm
45.8005	4.5x16.0x300cm
45.8006	4.5x16.0x400cm
45.8069	6.5x16.0x400cm
45.8070	6.5x16.0x500cm
45.8071	6.5x16.0x600cm

Plank, larch/douglas

Unplaned, fresh sawn, core-free, undried, top quality, sharp-edged and untreated



45.1901	2.8x3.6x400cm
45.0043	4.5x7.5x300cm
45.0044	4.5x7.5x400cm
45.0045	4.5x7.5x500cm
45.0041	5.0x10.0x300cm
45.0030	5.0x10.0x400cm
45.0040	5.0x10.0x500cm
45.0009	5.0x15.0x300cm
45.0010	5.0x15.0x400cm
45.0015	5.0x15.0x500cm
45.0065	6.3x15.0x500cm
45.0068	6.3x17.5x305cm
45.0069	6.3x17.5x425cm
45.0067	6.3x17.5x500cm
45.0054	7.0x20.0x400cm
45.0055	7.0x20.0x500cm
45.0056	7.0x20.0x600cm
45.0063	10.0x20.0x300cm
45.0062	10.0x20.0x400cm
45.0064	10.0x20.0x500cm
45.0061	10.0x20.0x600cm



larch/douglas wooden pegs

For concealing screw holes

42.9009	1.6x1.6x4.5cm
---------	---------------

pfs+ constructieschroeven

Deze revolutionaire constructieschroef met flenskop en TX opname is de ideale schroef voor houten constructies, zoals bijvoorbeeld houtskeletbouw, carports, etc. De grote kop zorgt voor een zeer hoge doortrekweerstand.



HOUTCONSTRUCTIESCHROEF met flenskop, T-drive

Met freesribben op de schacht, grove draad, speciaal snijpunt type 17, gehard en gewaxt

Art.nr.	ø	l	bit	
39.0401	8	80	Tx 40	p/st
39.0402	8	100	Tx 40	p/st
39.0403	8	120	Tx 40	p/st
39.0404	8	140	Tx 40	p/st
39.0405	8	160	Tx 40	p/st
39.0406	8	180	Tx 40	p/st
39.0407	8	200	Tx 40	p/st
39.0408	8	220	Tx 40	p/st
39.0409	8	240	Tx 40	p/st
39.0410	8	260	Tx 40	p/st
39.0411	8	280	Tx 40	p/st
39.0412	8	300	Tx 40	p/st
39.0413	8	340	Tx 40	p/st
39.0414	8	380	Tx 40	p/st

Plank, Central European impregnated pinewood

Planed with rounded angles



37.1518	1.5x14.0x180cm
37.1530	1.5x14.0x300cm
37.1540	1.5x14.0x400cm
37.16182	1.6x14.0x180cm
37.16195	1.6x14.0x195cm
37.1624	1.6x14.0x240cm
37.1627	1.6x14.0x270cm
37.16302	1.6x14.0x300cm
37.16362	1.6x14.0x360cm
37.16402	1.6x14.0x400cm
37.1645	1.6x14.0x450cm
37.1650	1.6x14.0x500cm
37.1718	1.7x14.0x180cm
37.2450	2.0x20.0x400cm

Plank, Central European impregnated pinewood

Fine sawn and sharp-edged



37.2490	1.7x14.5x180cm
37.2491	1.7x14.5x400cm
37.2400	2.0x20.0x400cm

Plank, Northern Swedish impregnated spruce

Planed, rounded angles and artificially dried



37.8124	1.8x14.5x240cm
37.8127	1.8x14.5x270cm
37.8130	1.8x14.5x300cm
37.8133	1.8x14.5x330cm
37.8136	1.8x14.5x360cm
37.8139	1.8x14.5x390cm
37.8142	1.8x14.5x420cm
37.8145	1.8x14.5x450cm
37.8148	1.8x14.5x480cm
37.8151	1.8x14.5x510cm
37.8154	1.8x14.5x540cm

Hardwood plank

Planed, 1 side 2x V-groove and rounded angles



37.4180	1.4x14.0x180cm
37.4195	1.4x14.0x195cm
37.4215	1.5x14.0x215cm
37.4245	1.5x14.0x245cm
37.4275	1.5x14.0x275cm
37.4305	1.5x14.0x305cm
37.4335	1.5x14.0x335cm
37.4365	1.5x14.0x365cm
37.4395	1.5x14.0x395cm
37.4425	1.5x14.0x425cm

Plank, larch/douglas

Planed, dried, core-free, top quality, rounded angles and untreated



45.1618	1.6x14.0x180cm
45.1640	1.6x14.0x400cm
45.1650	1.6x14.0x500cm

Edge board, larch/douglas

Planed, dried, core-free, top quality, sharp-edged and untreated



45.0510	1.9x19.0x400cm
45.0511	1.9x19.0x500cm

Edge board, larch/douglas

Unplaned, fresh sawn, core-free, top quality, sharp-edged and untreated



45.0016	1.8x14.0x180cm
45.0017	1.8x14.0x400cm
45.0302	2.2x20.0x300cm
45.0402	2.2x20.0x400cm
45.0502	2.2x20.0x500cm
45.0004	2.5x25.0x300cm
45.0002	2.5x25.0x400cm
45.0003	2.5x25.0x500cm
45.0014	3.2x20.0x300cm
45.0012	3.2x20.0x400cm
45.0013	3.2x20.0x500cm

Plank, Central European grey pinewood

Coated, planed with rounded angles



37.1618OG	1.6x14.0x180cm
37.1640OG	1.6x14.0x400cm

Plank, Central European grey pinewood

Coated, fine sawn and sharp-edged



37.2490OG	1.7x14.5x180cm
37.2491OG	1.7x14.5x400cm
37.2400OG	2.0x20.0x400cm

Scaffold plank, Central European spruce, untreated

Dried and sharp-edged



37.8553B	2.9x19.0x400cm
37.8557B	2.9x19.0x500cm

Scaffold plank, Central European spruce, silver grey impregnated
 Immersed, dried and sharp-edged



37.8553OG 2.9x19.0x400cm
 37.8557OG 2.9x19.0x500cm

Reversible shiplap T&G, kapur

Planed, artificially dried, with an effective width of 12.7cm



37.6430 1.6x14.0x300cm
 37.6440 1.6x14.0x400cm

Scaffold plank, Central European spruce, black coated

Coated surface 140 gr/m², dried and sharp-edged



37.8553ZW 2.9x19.0x400cm
 37.8557ZW 2.9x19.0x500cm

Reversible shiplap T&G, larch/douglas

Unplaned, fresh sawn, visible side fine sawn, core-free, top quality, untreated with an effective width of 12.7cm



45.7230 1.8x14.5x300cm
 45.7240 1.8x14.5x400cm

Central European T&G shiplap, impregnated pine

Planed, with an effective width of 12.7cm



37.7430 1.6x14.0x300cm
 37.7440 1.6x14.0x400cm

Roof boards, larch/douglas

Planed, dried, core-free, top quality and untreated with an effective width of 10.3cm



45.8007 1.6x11.6x300cm
 45.8008 1.6x11.6x400cm

Northern Swedish T&G shiplap, impregnated spruce

Planed, artificially dried, with an effective width of 13.3cm



37.7324 1.9x14.5x240cm
 37.7327 1.9x14.5x270cm
 37.7330 1.9x14.5x300cm
 37.7333 1.9x14.5x330cm
 37.7336 1.9x14.5x360cm
 37.7339 1.9x14.5x390cm
 37.7342 1.9x14.5x420cm
 37.7345 1.9x14.5x450cm
 37.7348 1.9x14.5x480cm
 37.7351 1.9x14.5x510cm
 37.7354 1.9x14.5x540cm

Tongue-and-groove board, impregnated, Central European pinewood

Planed, with an effective width of 12.8cm



37.3155 1.8x14.0x300cm
 37.3156 1.8x14.0x360cm
 37.3157 1.8x14.0x420cm
 37.3152 2.8x14.0x300cm
 37.3153 2.8x14.0x360cm
 37.3158 2.8x14.0x420cm

Reversible shiplap T&G, Northern Swedish spruce, black coated

Coated surface 140gr/m², fine sawn, dried with an effective width of 13.3cm



37.7930ZW 1.9x14.5x300cm
 37.7942ZW 1.9x14.5x420cm



Weatherboard profile plank, larch/douglas

Unplaned, fresh sawn, visible side fine sawn, core-free, top quality, untreated with an effective width of 12.7cm



45.4030 1.0-2.0x14.5x300cm
45.4040 1.0-2.0x14.5x400cm



Roofboard, larch/douglas T&G, 1-side chamfer

Planed, dried, core-free, top quality and untreated, with an effective width of 13.5cm



45.8020 1.8x14.5x300cm
45.8021 1.8x14.5x400cm
45.8022 1.8x14.5x500cm



Weatherboard profile plank, larch/douglas

Unplaned, fresh sawn, visible side fine sawn, core-free, top quality, untreated with an effective width of 17.4cm



45.4230 1.1-2.2x19.5x300cm
45.4240 1.1-2.2x19.5x400cm
45.4250 1.1-2.2x19.5x500cm



Roofboard, larch/douglas T&G, 2-sides chamfer

Planed, dried, core-free, top quality and untreated, with an effective width of 18.5cm



45.8015 1.8x19.5x300cm
45.8016 1.8x19.5x400cm
45.8017 1.8x19.5x500cm



Log cabin profile, Central European pinewood, impregnated

Planed, with an effective width of 11.5cm



40.9940 28x12.7x300cm
40.9941 28x12.7x360cm
40.9943 28x12.7x420cm



Double lip profile board, larch/douglas

Unplaned, fresh sawn, core-free, top quality, untreated, with an effective width of 17.4cm



45.5006 1.8x19.0x275cm
45.5000 1.8x19.0x300cm
45.5001 1.8x19.0x400cm
45.5002 1.8x19.0x500cm



Log cabin profile, Northern Swedish spruce, silver grey impregnated

Immersed, planed, with an effective width of 11.2cm



40.9945OG 2.8x12.1x180cm
40.9946OG 2.8x12.1x300cm
40.9947OG 2.8x12.1x360cm



Log cabin profile, Northern Swedish spruce, black impregnated

Immersed, planed, with an effective width of 11.2cm



40.9945Z 2.8x12.1x180cm
40.9946Z 2.8x12.1x300cm
40.9947Z 2.8x12.1x360cm



Offcuts, untreated larch/douglas

Unplaned and fresh sawn



45.6036 1.8x15.0-20.0x360cm
45.6130 2.5x25.0-30.0x300cm
45.6140 2.5x25.0-30.0x400cm
45.6150 2.5x25.0-30.0x500cm

Offcuts, impregnated pinewood

Unplaned and fresh sawn



37.6185 1.8x20.0-25.0x360cm

Eco rebated lap board, Northern Swedish spruce, green impregnated

Dried, rough and 2 round grooves with an effective width of 18.0cm



- 37.8724** 1.1/2.2x19.5x240cm
- 37.8730** 1.1/2.2x19.5x300cm
- 37.8736** 1.1/2.2x19.5x360cm
- 37.8742** 1.1/2.2x19.5x420cm



Excellent rebated lap board, Northern Swedish spruce, green impregnated

Dried, rough and 6 round grooves with an effective width of 18.0cm



- 37.8624** 1.4/2.8x19.5x240cm
- 37.8630** 1.4/2.8x19.5x300cm
- 37.8636** 1.4/2.8x19.5x360cm
- 37.8642** 1.4/2.8x19.5x420cm



Eco rebated lap board, Northern Swedish spruce, silver grey impregnated

Dried, rough and 2 round grooves with an effective width of 18.0cm



- 37.8730OG** 1.1/2.2x19.5x300cm
- 37.8742OG** 1.1/2.2x19.5x420cm



Excellent rebated lap board, Northern Swedish spruce, grey coated

Dried, rough and 6 round grooves with an effective width of 18.0cm



- 37.8624G** 1.4/2.8x19.5x240cm
- 37.8630G** 1.4/2.8x19.5x300cm
- 37.8636G** 1.4/2.8x19.5x360cm
- 37.8642G** 1.4/2.8x19.5x420cm



Plank, Central European impregnated pinewood

Dried, rough and 2 round grooves with an effective width of 18.0cm



- 37.8724ZW** 1.1/2.2x19.5x240cm
- 37.8730ZW** 1.1/2.2x19.5x300cm
- 37.8736ZW** 1.1/2.2x19.5x360cm
- 37.8742ZW** 1.1/2.2x19.5x420cm



Excellent rebated lap board, Northern Swedish spruce, black coated

Dried, rough and 6 round grooves with an effective width of 18.0cm



- 37.8624ZW** 1.4/2.8x19.5x240cm
- 37.8630ZW** 1.4/2.8x19.5x300cm
- 37.8636ZW** 1.4/2.8x19.5x360cm
- 37.8642ZW** 1.4/2.8x19.5x420cm



Excellent rebated lap board, Northern Swedish spruce, white coated

Dried, rough and 6 round grooves with an effective width of 18.0cm



- 37.8624W** 1.4/2.8x19.5x240cm
- 37.8630W** 1.4/2.8x19.5x300cm
- 37.8636W** 1.4/2.8x19.5x360cm
- 37.8642W** 1.4/2.8x19.5x420cm



CE
EN 14592

DE IDEALE SCHROEF VOOR POTDEKSELPLANKEN

Met boorpunt rvs met zwarte schroefkop

Art.nr.	Ø	l	bit	
39.0030	5	40	Tx25	200
39.0031	5	50	Tx25	200

- Houtschroef met gereduceerde bolverzonken kop
- Uiterst geschikt voor het bevestigen van schuttingplanken uit douglas, lariks of zelfs hardhout
- Zwarte poedercoating - RAL 9005 (UV bestendig)
- Kleine kop met 4 freesribben, verzinkt mooi in het hout+
- 6 freesribben op de schacht voor een spanningsvrije montage
- Speciale snijpunt "punt 17" voor snelle montage





45.8030
Grooved/intermediate post, larch/ douglas 11.5x11.5x300cm
 Planed, not dried, core-free, top quality and untreated Dimensions of groove: W3.0xL216cm



Galvanized U-profile ®
 for stacking profiles



1.59150 Cover cap 29mm
1.59150Z Cover cap 29mm powder coated

These specially developed products for Tuindeco are patented.

New



45.8031
Grooved/end post, larch/douglas 11.5x11.5x300cm
 Planed, not dried, core-free, top quality and untreated Dimensions of groove: W3.0xL216cm



Log cabin profile, larch/douglas

Planed, dried, core-free, top quality, untreated, with an effective width of 13.2 cm



45.2815 2.8x14.5x150cm
45.2820 2.8x14.5x200cm
45.2830 2.8x14.5x300cm
45.2840 2.8x14.5x400cm



45.8032
Grooved/corner post, larch/ douglas 11.5x11.5x300cm
 Planed, not dried, core-free, top quality and untreated Dimensions of groove: W3.0xL216cm



Create your own fence, shed, storage or roof with this extremely handy DIY larch construction system.
The figure shows a larch piling construction post with log cabin profile.

Palings

Impregnated pine

These posts have been cylindrically milled, pointed and topped



- 23.6060** Ø6x60cm
- 23.6100** Ø6x100cm
- 23.6120** Ø6x120cm
- 23.6160** Ø6x160cm
- 23.6180** Ø6x180cm
- 23.6250** Ø6x250cm
- 23.8060** Ø8x60cm
- 23.8180** Ø8x180cm
- 23.8250** Ø8x250cm

Coupling element, galvanised

For round posts Ø10cm

Set of 2

39.0349 2-way



Round milled post

Impregnated pine

The ends are topped.



- 24.1030** Ø10x300cm
- 24.1040** Ø10x400cm
- 24.1050** Ø10x500cm
- 24.1250** Ø12x500cm

Coupling element, galvanised

For round posts Ø10cm

Set of 2

39.0350 3-way



Round milled post

Impregnated pine



- 24.1260** Ø12x600cm
- 24.1440** Ø14x400cm
- 24.1450** Ø14x500cm
- 24.1460** Ø14x600cm
- 24.2050** Ø20x500cm
- 24.2060** Ø20x600cm
- 24.2550** Ø25x500cm
- 24.2560** Ø25x600cm
- 24.3050** Ø30x500cm
- 24.3060** Ø30x600cm

Coupling element, galvanised

For round posts Ø10cm

Set of 2

39.0351 4-way



Paling slat

Half-round Ø7x250cm

Impregnated pine



- 35.0725** Ø7x250cm

Coupling element, galvanised

For round posts Ø10cm

Set of 2

39.0352 Corner/end element



Rustic pinewood beam

12.0x22.0x260cm

Fine sawn, impregnated pine



34.5505 12.0x22.0x260cm



Hardwood slats

Fine sawn

37.4183 0.6x10.0x300cm
37.4184 0.6x10.0x400cm



Log roll

Impregnated pine



21.0020 20.0x250cm
½ Ø5cm
21.0030 30.0x250cm
½ Ø5cm
21.0040 40.0x250cm
½ Ø5cm



Sheet pile wall

Dimensions: 4.0x17.0x300cm

Impregnated pine



28.0300



Log roll, hardwood



21.1030 30.0x180cm
½ Ø5cm



A sheet pile wall is a soil and/or water retaining structure consisting of a wall placed vertically in the ground. The wall is made of separate planks that are linked to each other by tongue-and-groove connections.





In order to be able to create some wonderful relaxing spots in your garden as well, we provide various options for creating a terrace, decking or scaffolding. This can include decking, composite components, gravel, etc.



44.0009
Granite grit 8-16mm
 Big-bag of ± 1000kg



44.0004
Gravel 16-32mm
 Big-bag of ± 1000kg



44.0013
Yellow Sun 11-22mm
 Big-bag of ± 1000kg



44.0001
Gravel, dark assorted 8-16mm
 Big-bag of ± 1000kg



44.0006
Mine grit, red 10-20mm
 Big-bag of ± 1000kg



44.0021
Basalt grit 8-11mm
 Big-bag of ± 1000kg



44.0003
Gravel 8-16mm
 Big-bag of ± 1000kg



44.0008
Ardennes grit, grey 8-16mm
 Big-bag of ± 1000kg

Decking plank, Central European impregnated pinewood

Underside planed and top side rough relief

37.3130 2.8x14.0x300cm
37.3140 2.8x14.0x400cm



Hardwood decking plank

Underside planed and top side rough relief

37.2139 2.1x14.5x400cm
37.2539 2.5x14.5x400cm



Plank, Northern Swedish impregnated spruce

Planed, rounded angles and artificially dried

37.8242 2.8x19.5x420cm
37.8251 2.8x19.5x510cm



Kapur decking plank

Underside planed and top side rough relief

37.2224 2.1x14.5x245cm
37.2227 2.1x14.5x275cm
37.2230 2.1x14.5x305cm
37.2233 2.1x14.5x335cm
37.2236 2.1x14.5x365cm
37.2239 2.1x14.5x400cm
37.2242 2.1x14.5x430cm
37.2245 2.1x14.5x460cm
37.2248 2.1x14.5x490cm



Decking plank, larch/douglas

Planed, undried, core-free, top quality, underside planed and top side rough relief

45.2730 2.8x14.5x300cm
45.2740 2.8x14.5x400cm
45.2750 2.8x14.5x500cm



Kapur decking plank

Underside planed and top side rough relief

37.2624 2.5x14.5x245cm
37.2627 2.5x14.5x275cm
37.2630 2.5x14.5x305cm
37.2633 2.5x14.5x335cm
37.2636 2.5x14.5x365cm
37.2639 2.5x14.5x400cm
37.2642 2.5x14.5x430cm
37.2645 2.5x14.5x460cm
37.2648 2.5x14.5x490cm



Plank, larch/douglas

2-sided planed, dried, top quality and core-free

45.0006 2.8x17.5x400cm



Kapur decking plank

2-sided planed

37.271936 2.7x19.0x365cm
37.271939 2.7x19.0x395cm



Laying tips pine, larch/douglas and hardwood decking planks:

- Lay a buffeted layer of sand of at least 25 cm.
- Cover this with Weed matting and then place the 30x30 tiles every 50cm in linear and crossing direction. Place the bottom slats on the tiles, 40cm centre-to-centre.

Mount the bottom slats to the tiles with corner supports if necessary.

- If the underground is unstable (e.g. peat), then the use of wooden stakes instead of tiles is recommended to prevent sagging.
- A space of at least 1 cm must be kept open from the wall to the first row of planks for warpage.
- Clearance between the planks 0.5 cm (=ruler gauge) and clearance between on-end joints (butt joint) 0.3 cm. This in view of wood warpage.

COMPOSITE DECKING PLANK

Laying tips Premium composite decking planks:

- Distance between support beams 30cm centre-to-centre
- Attach the clips at the same height to both sides of the decking plank.
- Use the end cap or edge trim to prevent flooding.
- Premium composite may shrink or expand by 5% in length and width.
- You should therefore always keep at least 0.5 cm (=ruler gauge) distance between the decking elements.
- If the elements are laid head-on, the space must be at least 2 cm.
- You should ensure there is a pitch of at least 2%, or 2 cm per metre
- The support beams of Premium Composite decking must be attached to a strong foundation (such as concrete).
- Ask your retailer for the special folder with laying instructions.



37.5540
Premium composite
2.1x15.0x400cm, charcoal
 Coloured through and through,
 100% recyclable, 60% wood /
 40% synthetic, underside smooth
 planed, top side rough relief



37.5550
Premium composite
2.1x15.0x400cm, redwood
 Coloured through and through,
 100% recyclable, 60% wood /
 40% synthetic, underside smooth
 planed, top side rough relief



37.5580
Premium composite
2.1x15.0x400cm, classic grey
 Coloured through and through,
 100% recyclable, 60% wood /
 40% synthetic, underside smooth
 planed, top side rough relief



37.5650
Excellent solid composite
2.0x14.0x400cm, charcoal
 Coloured through and through,
 100% recyclable, 60% wood /
 40% synthetic, underside smooth
 planed, top side rough relief



37.5560
Premium composite
2.1x15.0x400cm, natural
 Coloured through and through,
 100% recyclable, 60% wood /
 40% synthetic, underside smooth
 planed, top side rough relief



37.5651
Excellent solid composite
2.0x14.0x400cm, classic grey
 Coloured through and through,
 100% recyclable, 60% wood /
 40% synthetic, underside smooth
 planed, top side rough relief



37.5570
Premium composite
2.1x15.0x400cm, coffee
 Coloured through and through,
 100% recyclable, 60% wood /
 40% synthetic, underside smooth
 planed, top side rough relief



37.5652
Excellent solid composite
2.0x14.0x400cm, natural
 Coloured through and through,
 100% recyclable, 60% wood /
 40% synthetic, underside smooth
 planed, top side rough relief

Tuindeco Premium decking elements are tested at every production cycle for their resistance to pulling, bending, breaking and UV. The wall thickness of the hollow decking determines the quality. Tuindeco Premium hollow decking elements therefore have extra thick walls, whereby a high density of 2.90 kg per linear metre is achieved.



37.5504
Composite lower girder
3.0x5.0x220cm

Synthetic floor support

Adjustable and made from new plastic



40.2073

Adjustable 3 to 6 cm Maximum weight 450 kg

40.2074

Adjustable 6 to 14 cm Maximum weight 1400 kg

Edge trim aluminium

Thickness: 0.2cm



- 37.5515** 3.8x3.8x220cm Redwood
- 37.5516** 3.8x3.8x220cm Natural
- 37.5517** 3.8x3.8x220cm Classic grey
- 37.5518** 3.8x3.8x220cm Coffee
- 37.5519** 3.8x3.8x220cm Charcoal

Edge trim aluminium



End cap premium composite

Suitable for Premium composite section with thickness of 15.0cm



- 37.5557** Redwood
- 37.5567** Natural
- 37.5587** Classic grey
- 37.5577** Coffee
- 37.5547** Charcoal

End cap antraciet



Stainless steel clip

Including stainless steel screw



- 37.5505** Regular clip
- 37.55051** Start/end clip



Decking to specification per m²

You specify the dimensions and the direction of the decking, and the required materials are supplied rounded off to whole m². The mentioned m² price includes all decking elements, support beams and screws.

Decking plank 2.8x14.0cm Central European impregnated pine

Decking plank 2.8x14.5cm Larch/Douglas

Decking plank 2.8x17.5cm Larch/Douglas, smooth planed

Decking plank 2.8x19.5cm Northern Swedish impregnated spruce, smooth planed

Decking plank 2.1x14.5cm Kapur hardwood

Decking plank 2.5x14.5cm Kapur hardwood

Decking plank 2.7x14.5cm Kapur hardwood, smooth planed

Premium composite 2.0x14.0cm charcoal, natural

Premium composite 2.0x14.0cm classic grey

Excellent solid composite 2.0x14.0cm charcoal, natural, coffee, redwood

Excellent solid composite 2.0x14.0cm classic grey



pfs+ DECKING SCREWS

pfs⁺ - screw[®]

The special alloy* from which these stainless screws are made, make them extremely suitable for the construction of wooden decking!

- The drilling point prevents wood from cracking and contributes to a speedy assembly
- 6 milling ribs on the shank decrease wood tension
- Small head sinks in between the wood ribs

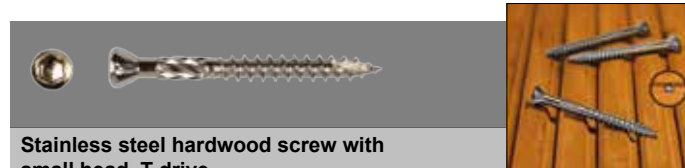

Stainless steel hardwood screw with small head, T-drive

60° head with 4 milling ribs, milling ribs on the shank, special drilling tip, tempered and waxed

Art.no.	ø	l	bit	
39.0660	4	40	Tx 15	200
39.0661	5	40	Tx 25	200
39.0662	5	50	Tx 25	200
39.0663	5	60	Tx 25	200
39.0664	5	70	Tx 25	200

* Stainless steel AISI 410, tempered and passified.
Not suitable for use in salt- or chlorine-containing environments.



Anti-weed matting

Lets water through, but not weeds

For use under natural stone, pavements, log cabins, decking and gravel



- 33.0050** Width 50cm
- 33.0100** Width 105 cm
- 33.0131** Width 131 cm
- 33.0165** Width 165 cm
- 33.0200** Width 210cm
- 33.0330** Width 330cm
- 33.0420** Width 420cm
- 33.0525** Width 525 cm

Artificial grass

Pile height: 3.0cm Stitches per metre: 180 Colour: green

Material: 10800 Dtex monofill PE with curled PP roots of the same material

Laying instructions: provide a base layer of stabilised sand



- 33.9999** Width 200cm
- 33.9998** Self-adhesive strip
W12.0xL1000cm
- 44.0101** Filling sand
Bag of 25 kg 8 kg per m2 required



17.5002
Premium Garden Decking Tiles, Composite Charcoal
Dimensions: L30xW30cm
Bar: D1.2xW7.0cm
4 planes, mosaic
Structure: relief
Featuring a synthetic click-on system



17.5003
Premium Garden Decking Tiles, Composite Coffee
Dimensions: L30xW30cm
Bar: D1.2xW7.0cm
4 planes, mosaic
Structure: relief
Featuring a synthetic click-on system

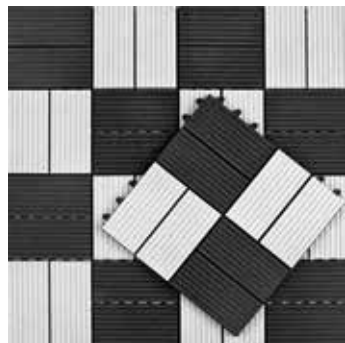

17.5001
Premium Garden Decking Tiles, Composite Quartz
Dimensions: L30xW30cm
Bar: D1.2xW7.0cm
4 planes, mosaic
Structure: relief
Featuring a synthetic click-on system



17.9004
Bandung - Garden Decking Tile, Hardwood
Dimensions: L40xW40cm
Bar: D1.4xW4.0cm
Structure: planed
9 planes mosaic
Featuring a synthetic click-on system



17.9008
Siantar - Garden Decking Tile, Hardwood
Dimensions: L30xW30cm
Bar: D1.2xW6.8cm
Structure: planed, 4 bars
Featuring a synthetic click-on system





Round decking

Bar: D1.7xW9.0cm

Structure: relief
impregnated pine

- 14.0400** Round decking Ø40cm
- 14.0600** Round decking Ø60cm
- 14.0800** Round decking Ø80cm
- 14.1000** Round decking Ø100cm
- 14.1200** Round decking Ø120cm
- 14.1400** Round decking Ø140cm
- 14.1600** Round decking Ø160cm
- 14.1800** Round decking Ø180cm



17.1100

Scheveningen - Garden Decking Tile

Dimensions: L100xW100cm

Bar: D1.7xW9.0cm

Structure: relief, impregnated
pine



17.0100

Den Helder - Garden Decking Tile

Dimensions: L100xW100cm

Bar: D1.7xW9.0cm

Structure: relief, impregnated pine



17.0005

Egmond - Garden Decking Tile

Dimensions: L50xW50cm

Bar: D1.6xW9.0cm

Structure: relief, impregnated pine



17.9006

Surabaya - Garden Decking Tile, Hardwood

Dimensions: L50xW50cm

Bar: D1.4xW2.0cm

Structure: planed



17.9010

Yogyakarta - Garden Decking Tile, Hardwood

Dimensions: L100xW100cm

Bar: D1.4xW2.0cm

Structure: planed





For every garden, a suitable object according to your own taste. For example a garden cabinet, metal storage unit as well as attractive flower planter or etagere.



27.0003
Circular pergola, including galvanised roof rosette
 Dimensions: Ø390cm (outer surface posts)xH245cm
 Post length: 210cm
 Impregnated pine
 Including fitting kit



27.0004
Corner pergola
 Dimensions: Ø1/4x300cm (girder length)
 Post length: 270cm
 Impregnated pine
 Including fitting kit



27.0002

Pergola flower planter set

Dimensions: W193xD54xH245cm

Impregnated pine

Including fitting kit



27.0001

Pergola bench set

Dimensions: W287xD54xH270cm

Impregnated pine

Including fitting kit



Pergola set

Post length: 200cm

Impregnated pine

Including fitting kit

- 27.0006** Pergola set, arch
Dimensions: W90xD54xH214cm
- 27.0005** Pergola set, straight
Dimensions: W100xD54xH210cm
- 27.0007** Pergola set, arch
Dimensions: W120xD54xH254cm
- 27.0008** Pergola set, arch
Dimensions: W120xD54xH215cm
- 27.0009** Pergola set, arch
Dimensions: W180xD54xH215cm



29.0071
Storage box
 Dimensions: W125xD53xH56cm
 Larch/douglas
 Including fitting kit



29.0010
Luxury potting bench
 Dimensions: W122xD46xH82cm
 Impregnated pine
 Including zinc tray and fitting kit



29.0018
Workbench XXL
 Dimensions: W180xD50xH80cm
 Impregnated spruce
 Including zinc top and fitting kit



29.0017
Vegetable garden table
 Dimensions: W85xL60xH82cm
 Impregnated pine
 Including storage shelf and 6 plastic trays

**29.1101****Metal garden cabinet Titan**

With folding doors

Dimensions: W182.2xD107.3xH197cm

Door: W99.2xH180cm

Steel thickness: 0.25mm

**29.1102****Metal storage Eco**

With sliding doors

Dimensions: W192.2xD117.6xH194.5cm

Door: W84xH163cm

Steel thickness: 0.25mm

Including air vents

**29.1103****Metal storage Platinum**

With sliding doors

Dimensions: W247.5xD194xH212cm

Door: W120xH173cm

Steel thickness: 0.30mm

Including gutter and air vents

**Metal storage**

With sliding doors

Steel thickness: 0.30mm

Including gutter and air vents

29.1104 Metal storage Diamant
Dimensions: W247.5xD301xH212cm
Door: W120xH173cm

29.1105 Metal storage Saffier
Dimensions: W290.5xD290.5xH217.5cm
Door: W125xH173cm



29.0001
Garden cabinet Holland
 Dimensions: W60xD30xH182cm
 Impregnated pine
 Including fitting kit



29.0019
Garden cabinet Veluwe
 Dimensions: W93xD63xH173/185cm
 Impregnated, dried spruce
 Including roofing felt and fitting kit



29.0044
Garden cabinet Vaals
 Dimensions: W153xD73xH187cm
 Impregnated, dried spruce
 Including roofing felt and fitting kit



29.0002
Garden cabinet Drenthe
 Dimensions: W123xD83xH220cm
 Impregnated, dried spruce
 Including roofing felt and fitting kit



29.0003

Garden cabinet Bayern

Dimensions: W153xD73xH187cm

Impregnated, dried spruce

Including roofing felt and fitting kit



29.2005

Garden cabinet Santiago

Dimensions: W80xD65xH173/185cm

This garden cabinet has been treated with oil

Including roofing felt and fitting kit



29.2003

Garden cabinet Montevideo

Dimensions: W145xD65xH173/185cm

This garden cabinet has been treated with oil

Including roofing felt and fitting kit



29.0016

Shed Westerwald

Dimensions: W200xD90xH158cm

Impregnated spruce

Including roofing felt and fitting kit



29.0004

Single container storage

Dimensions: W70xD85xH135cm

Wood thickness: 12mm

Impregnated pine

Including fitting kit

Suitable for containers up to W60xD76xH110cm



29.0005

Double container storage

Dimensions: W140xD85xH135cm

Wood thickness: 12mm

Impregnated pine

Including fitting kit

Suitable for containers up to W60xD76xH110cm



29.1004

Single container storage, hardwood

Dimensions: W75xD75xH135cm

Thickness wooden walls: 1.8cm

This garden cabinet has been treated with oil

Including gas strut and fitting kit

Suitable for containers up to W60xD60xH106cm



29.1005

Double container storage, hardwood

Dimensions: W150xD75xH135cm

Thickness wooden walls: 1.8cm

This garden cabinet has been treated with oil

Including gas strut and fitting kit

Suitable for containers up to W60xD60xH106cm



29.0046

Triple container storage

Dimensions: W215xD80xH120cm

Wood thickness: 12mm

Impregnated spruce

Including fitting kit

Suitable for containers up to W60xD67xH110cm



29.0012

Firewood storage

Dimensions: W180xD50xH180cm

Impregnated pine

Including roofing felt and fitting kit



8.30250

Plant étagère Moestuin

Dimensions: W90xH180cm

Planks of W1.6xD14.0cm

Planed, impregnated pine, stainless steel screwed

For assembly onto a fence or wall

Teak planter Java



- 25.0250 Java small
L35xW35xH70cm
- 25.0260 Java large
L45xW45xH90cm

Teak planter Flores



- 25.0280 Flores small
L58xW40xH36cm
- 25.0290 Flores large
L82xW58xH47cm

Teak planter Bali



- 25.0240 Bali small
L35xW70xH37cm
- 25.0270 Bali large
50xW100xH50cm

Teak planter Kalimantan



- 25.0320 Kalimantan small
L40xW40xH45cm
- 25.0330 Kalimantan large
L51xW51xH56cm



- 25.0230
Lombok - teak planter
L45xW45xH47cm





Every child has his or her particular taste and wishes. Thanks to our wide range of playhouses, play centers and accessories, every wish can be met. In this way, your child can also enjoy the garden.



Blue Rabbit Free swing

- This kit consists of:
- Construction plan
- Fitting kit
- 4 Ground anchors
- 4 Swing hooks

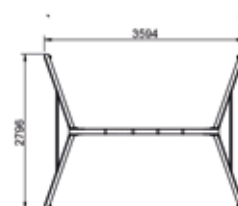

Supplied excluding recreational accessories

- 32.1570** Blue Rabbit Free swing
- 32.1572** Free swing timber pack with posts 8.8x8.8cm



Blue Rabbit @Swing

- This kit consists of:
- Construction plan
- Fitting kit
- 2 Ground anchors
- 4 Swing hooks

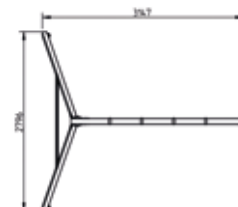

Is supplied excluding recreational accessories

- 32.1600** Blue Rabbit @Swing
- 32.1602** @Swing Timber pack with posts 8.8x8.8cm

BLUE RABBIT SELF-CONSTRUCTION PLAYING DEVICES

With the do-it-yourself packages of Blue Rabbit®, quality and safety come first. You build your own unique playground equipment step by step. You can vary endlessly through the many play sets and modules. To assemble your playground equipment you must order both the wood package and the Blue Rabbit kit.



Blue rabbit Deckswing

- This kit consists of:
 Construction plan
 Fitting kit
 4 Handlebars
 4 Ground anchors
 4 Swing hooks

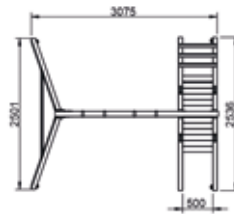

Supplied excluding slide and recreational accessories

- 32.1530** Blue rabbit Deckswing
32.1532 Deck swing timber pack with posts
 8.8x8.8cm



Blue Rabbit Kiosk

- This kit consists of:
 Construction plan
 Fitting kit
 4 Handlebars
 2 Ground anchors

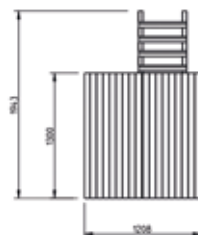

Supplied excluding slide, sectional swing and recreational accessories

- 32.1505** Blue Rabbit Kiosk
32.1507 Kiosk timber pack with posts 8.8x8.8cm



Blue Rabbit Beach Hut

- This kit consists of:
 Construction plan
 Fitting kit
 5 Handlebars
 2 Ground anchors

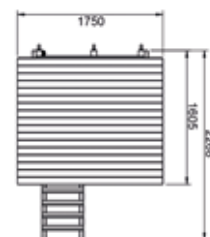

Supplied excluding slide, sectional swing and recreational accessories

- 32.1525** Blue Rabbit Beach Hut
32.1527 Beach Hut timber pack with posts
 8.8x8.8cm



Blue Rabbit Belvédère

- This kit consists of:
 Construction plan
 Fitting kit
 5 Climbing elements
 5 Handlebars
 2 Ground anchors

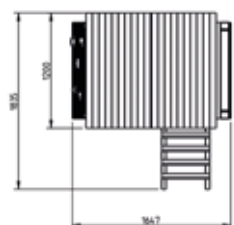

Supplied excluding slide, sectional swing and recreational accessories

- 32.1535** Blue Rabbit Belvédère
32.1537 Belvédère timber pack with posts
 8.8x8.8cm



Blue Rabbit Penthouse

- This kit consists of:
- Construction plan
- Fitting kit
- 13 Handlebars
- 3 Ground anchors
- 5 Climbing elements

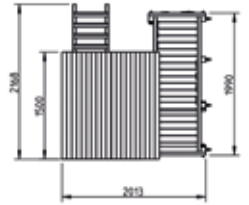

Supplied excluding slide and recreational accessories

- 32.1515** Blue Rabbit Penthouse
- 32.1517** Penthouse timber pack with posts
8.8x8.8cm



Blue Rabbit Pagoda

- This kit consists of:
- Construction plan
- Fitting kit
- 6 Handlebars
- 2 Ground anchors

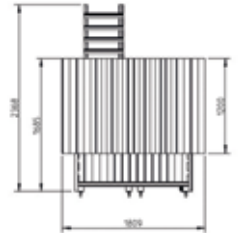

Supplied excluding slide and recreational accessories

- 32.1555** Blue Rabbit Pagoda
- 32.1557** Pagoda timber pack with posts
8.8x8.8cm



Blue Rabbit Cascade

- This kit consists of:
- Construction plan
- Fitting kit
- 4 Handlebars
- 2 Ground anchors

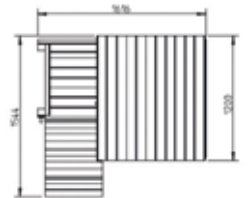

Supplied excluding slide and recreational accessories

- 32.1545** Blue Rabbit Cascade
- 32.1547** Cascade timber pack with posts
8.8x8.8cm



Blue Rabbit @Steps

- This kit consists of:
- Construction plan
- Fitting kit

- 32.1670** Blue Rabbit @Steps
- 32.1672** @Steps timber pack, 150cm with posts
8.8x8.8cm



Blue Rabbit @Platform

This kit consists of:
 Construction plan
 Fitting kit
 4 Handlebars

Supplied excluding slide

- 32.1680** Blue Rabbit @Platform
- 32.1682** @Platform timber pack with posts 8.8x8.8cm



Blue Rabbit @Challenger

This kit consists of:
 Construction plan
 Fitting kit
 8 Climbing elements
 1 Climbing net

- 32.1650** Blue Rabbit @Challenger
- 32.1652** @Challenger timber pack with posts 8.8x8.8cm



Blue Rabbit @Wall

This kit consists of:
 Construction plan
 Fitting kit
 5 Climbing elements

- 32.1630** Blue Rabbit @Wall
- 32.1632** @Wall timber pack with posts 8.8x8.8cm



Blue Rabbit @Ramp

This kit consists of:
 Construction plan
 Fitting kit
 Climbing rope

- 32.1620** Blue Rabbit @Ramp
- 32.1621** @Ramp timber pack with posts 8.8x8.8cm



Blue Rabbit @Bridge

This kit consists of:
Construction plan
Fitting kit
Net

- 32.1640** Blue Rabbit @Bridge
- 32.1641** @Bridge timber pack with posts 6.8x6.8cm



32.1610

Blue Rabbit @Net

This kit consists of:
Construction plan
Fitting kit
Climbing net



See-Saw

Suitable for public use

- 32.1012** See-Saw Seat with handlebar, per piece
- 32.1013** Hinge for see-saw
- Required wood:
2 pieces 1.12400 impregnated garden posts 12x12x400cm



Horizontal bar Rudolf for play center

Dimensions: W190xH160cm
Posts: Ø10x300cm

Supplied including:
2 Galvanised round horizontal bars 80cm
Fitting kit
3 Bags of concrete

Must be dug into the ground 50cm and embedded in a concrete base

- 32.0650** Horizontal bar Rudolf for play center
- 32.0017** Horizontal bar for round posts Ø10cm
- 32.0019** Horizontal bar for square posts 9.0x9.0cm



32.0250
Swing set Paula
 Dimensions: W300xH250cm
 Swing beam: Ø10

Supplied including:
 Fitting kit
 2 Swing hooks
 Plastic swing
 4 Bags of concrete

Must be dug into the ground 75cm and embedded in a concrete base
 You make this base yourself from the concrete



32.0150
Swing set Econoom
 Dimensions: W300xD230xH225cm
 Swing beam: Ø10

Supplied including:
 Fitting kit
 4 Screw anchors

This play center is supplied excluding recreational accessories



32.0300
Swing set Maxim
 Dimensions: W300xD230xH225cm
 Swing beam: Ø10

Supplied including:
 Fitting kit
 4 Screw anchors
 4 Swing hooks
 2 Plastic swings



32.0350
Swing set Robuust
 Dimensions: W350xD250xH225cm
 Swing beam: Ø10

Supplied including:
 Falling protection
 Fitting kit
 4 Screw anchors

This play center is supplied excluding slide and recreational accessories
 With top-mounted rungs and milled connections



32.0600

Swing set Antoine

Dimensions: W500xD230xH230cm

Swing beam: Ø10

- Supplied including:
- Falling protection
 - Fitting kit
 - 4 Screw anchors
 - 6 Swing hooks
 - Plastic swing
 - Rope ladder
 - Baby swing
 - Stair section has a platform

This play center is supplied excluding slide
With milled rungs



32.0700

Playtower Alex

Dimensions: W430xD315xH349cm

Swing beam: Ø10

- Supplied including:
- Fitting kit
 - 4 Screw anchors
 - 4 Swing hooks
 - Wooden swing
 - Ring trapeze
 - Stair section has a platform

This play center is supplied excluding slide



40.0127

Playtower Voldemort

Dimensions: W120xD204cm (including terrace)

Posts 8.8x8.8cm

Ridge height: 293cm

- Supplied including:
- Including roofing felt
 - Wooden floor
 - Fitting kit

This play center is supplied excluding slide

This playhouse is supplied with wall sections.





Playtower Robin

Dimensions: W135xD135xH324cm

Supplied fully sawn and pre-drilled, including:
Fitting kit
4 Screw anchors
Picnic set
Sturdy stairs with flat rungs

This play center is supplied excluding slide and recreational accessories.

32.2118 Playtower Robin
32.2101 Swing section
Dimensions: W295xD250xH245 cm
Swing beam: 9x9 cm

Supplied including:
4 swing hooks
2 ground anchors
Fitting kit



Playtower Sjoerd

Dimensions:
W256xD130xH337cm

Supplied fully sawn and pre-drilled, including:
Fitting kit
4 Screw anchors
Stairs with round rungs

This play center is supplied excluding slide and recreational accessories.

32.2116 Playtower Sjoerd
32.2105 Climbing rack and swing section
Dimensions: W300xD240xH245 cm
Swing beam: 9x9 cm

Supplied including:
2 swing hooks
2 ground anchors
Fitting kit



Playtower Armin

Dimensions:
W127xD127xH310cm

Supplied fully sawn and pre-drilled, including:
Fitting kit
4 Screw anchors
Picnic set
Stairs with round rungs

This play center is supplied excluding slide.

32.2114 Playtower Armin
32.2106 Sectional veranda
Supplied fully sawn and pre-drilled.





32.2107

Sturdy stairs

Platform height: 150cm

Supplied mounted

Slides

Platform height: 130-160cm

- 32.5010** Slide, plastic, 300cm Blue
- 32.5011** Slide, plastic, 300cm Yellow
- 32.5012** Slide, plastic, 300cm Green
- 32.5013** Slide, plastic, 300cm Red
- 32.5014** Slide, plastic, 300cm Apple-green
- 32.5015** Slide, plastic, 300cm Violet
- 32.5001** Slide, plastic, 250cm Blue
Platform height: 120cm
- 32.5000** Slide, plastic, 130cm Blue
Platform height: 60cm



Rubber tiles

Dimensions: L50xW50cm

Thickness: 2.5cm

- 32.9902** Rubber tile Black
- 32.9903** Rubber tile Green
- 32.9904** Rubber tile Red





Sandbox, square with cover impregnated pine

Wood thickness: 1.6cm

Sitting boards all around

Including fitting kit

16.6100 Sandbox, square with cover
Dimensions: L100xW100xH24cm

16.4120 Sandbox, square with cover
Dimensions: L120xW120xH24cm



16.6175

Sandbox, hexagonal with cover impregnated pine

Dimensions diagonal: L175xW175xH30cm

Wood thickness: 1.6cm

Sitting boards all around

Including fitting kit



16.6180

Sandbox, with bench cover impregnated pine

Dimensions: L120xW120xH30cm

Wood thickness: 1.6cm

Including fitting kit



16.5120

Hardwood sandbox including canvas cover

Dimensions: L120xW120xH30cm

Wood thickness: 1.4cm

Sitting boards all around

Including fitting kit





44.0100
Playing sand bag of 25 kg



32.0030
Blue Rabbit picnic kit



30.1011
Children's picnic table, hardwood
Dimensions: L80xW71xH53cm
Top and bench thickness: 2.7cm
Colourfully coated
Including fitting kit



30.0011
Children's picnic table, impregnated pine
Dimensions: L100xW100xH56cm
Top and bench thickness: 2.5cm
Including fitting kit



32.0018
Plastic swing



32.0998
Duo Seat



32.0023
Black rubber swing seat with chain
Also for public use



32.9951
Duo seat, metal



32.0001
Wooden swing



32.0022
Car tyre swing with rope



32.0012
Belt swing



32.0008
Bird's nest swing
Ø100cm



32.9966
Growing swing



32.0013
Ring trapeze



32.0009
Baby swing



32.0004
Horizontal bar, wood



32.9977
Ventelino lime



32.9955
4-sided rope ladder
Length: 240cm



32.0003
Ring set



32.9956
Climbing net
Dimensions: W125xH200cm



32.0028
Cableway 30m



32.9959
Punch bag



32.0029
Disk seat for cableway



32.0027
Binoculars



32.0002
Knotted rope
Length: 190cm
Thickness: 26mm



32.0016
Telescope



32.0010
Wooden rope ladder



32.9957
Periscope



32.0015
Steering wheel



32.0014
Handlebar
Price per set of 2

Bolt Caps
M8-10



32.0061 Blue
32.0062 Yellow



32.0005
Screw anchor for play center



32.0011
Swing hook, drill-through model
For posts to maximum of Ø10cm



32.0006
Swing hook, round
For posts of Ø10cm



32.0060
Swing hook, square
For posts of 9.0x9.0cm



32.9960
Swing hooks for Duo Seat
Duo seats require the use of 2 hooks. Suitable for posts with maximum dimensions Ø10cm and square 9cm.



32.0020
Screw-in swing hook
For posts to maximum of Ø10cm
With safety clip

New

40.0172

Tiny Pipo - Playhouse

Dimensions: W90xD122cm (excluding porch and stairs)
19mm untreated spruce
Ridge height 181cm
Inside height 114cm
Including roofing felt, wooden floor and fitting kit

This playhouse is supplied with pre-assembled wall sections.





40.0100

Pippi - Playhouse

Dimensions: W140xD100cm
16mm impregnated pinewood
Ridge height: 150cm

Including roofing felt, wooden floor and fitting kit

This playhouse is supplied with pre-assembled wall sections.



40.0124

Gandalf - Playhouse

Dimensions: W135xD110cm
19mm untreated spruce
Ridge height: 140cm

Including roofing felt and fitting kit



40.0110

Snow White - Playhouse

Dimensions: W152xD122cm (excluding porch)
16mm untreated spruce
Ridge height: 166cm

Including roofing felt, wooden floor and fitting kit

This playhouse is supplied with pre-assembled wall sections.



40.0101

Pinokkio - Playhouse

Dimensions: W115xD140cm (excluding terrace 40cm)
16mm untreated spruce
Ridge height: 160cm

Including roofing felt, wooden floor and fitting kit

This playhouse is supplied with pre-assembled wall sections.



40.0106

Aladdin - Playhouse

Dimensions: W180xD120cm (excluding porch 60cm)
 16mm untreated spruce
 Ridge height: 168cm
 Including roofing felt, wooden floor and fitting kit

This playhouse is supplied with pre-assembled wall sections.



40.0104

Peter Pan - Playhouse

Dimensions: W180xD120cm (excluding terrace 60cm)
 16mm untreated spruce
 Posts 6.8x6.8cm untreated spruce
 Ridge height: 257cm
 Including roofing felt, wooden floor and fitting kit

This playhouse is supplied with pre-assembled wall sections.



40.0118

Finland - Playhouse

Dimensions: W194xD194cm (excluding terrace 70cm)
 19mm untreated spruce
 Ridge height: 185cm
 Including roofing felt, wooden floor and fitting kit



40.0102

Assepoester - Playhouse

Dimensions: W220xD168cm (excluding terrace 47cm)
 16mm untreated spruce
 Ridge height: 228cm
 Including roofing felt, wooden floor and fitting kit



This playhouse has a storey floor and is supplied with pre-assembled wall sections.



40.0122

Lola - Playhouse

Dimensions: W220xD180cm (excluding porch 30cm)
 16mm untreated spruce
 Ridge height: 230cm
 Including roofing felt, wooden floor and fitting kit

This playhouse is supplied with pre-assembled wall sections.



40.0109

Sleeping Beauty - Playhouse

Dimensions: W240xD169cm
 16mm untreated spruce
 Ridge height: 230cm
 Including roofing felt, wooden floor and fitting kit

This playhouse is supplied with pre-assembled wall sections.



40.0107

Alice - Playhouse

Dimensions: W180xD240cm
 16mm untreated spruce
 Ridge height: 244cm
 Including roofing felt, wooden floor and fitting kit

This playhouse is supplied with pre-assembled wall sections.



40.0123

Marii - Playhouse

Dimensions: W235xD235cm (excluding terrace 75cm)
 28mm untreated spruce
 Ridge height: 211cm
 Including roofing felt, wooden floor and fitting kit



Our animal houses provide a pleasant and safe shelter for your pets, and are easy to assemble.



26.0065
Zijdehoen - Rabbit Hutch
 Dimensions: L130xD60xH110cm
 Impregnated spruce
 Including roofing felt and fitting kit



26.0083
Rijnlander - Rabbit Hutch
 Dimensions: L134xD60xH130cm
 Impregnated spruce
 Including roofing felt and fitting kit



26.0092

Teckel - Dog Kennel

Dimensions: L130xD93xH97cm

Impregnated spruce

Including roofing felt, floor, stainless steel entrance frame and fitting kit



26.0096

Labrador - Dog Kennel

Dimensions: L118.5xD86xH93cm

Impregnated spruce

Including roofing felt, floor, stainless steel entrance frame and fitting kit.



26.0095

Bulldog - Dog Kennel

Dimensions: L150xD120xH110cm

Impregnated spruce

Including roofing felt, floor, stainless steel entrance frame and fitting kit



26.0094

Boxer - Dog Kennel

Dimensions: L150xD120xH100cm

Impregnated spruce

Including roofing felt, floor, stainless steel entrance frame and fitting kit



26.0066

Lakenvelder - Chicken Coop

Dimensions: L163xD90xH140cm

Impregnated spruce

Including hinged roof, laying nest, roost, roofing felt and fitting kit



26.0061

Barnevelder - Chicken Coop

Dimensions: L218xD78xH136cm

Impregnated spruce

Including coop door, laying nest, roost, roofing felt and fitting kit



26.0062

Wyandotte - Chicken Coop

Dimensions: L190xD95xH165cm

Impregnated spruce

Including coop door, plexiglass window, laying nest, roost, roofing felt and fitting kit



26.0067

Chabo - Chicken Coop

Dimensions: L100xD300xH170cm

Impregnated spruce

Including coop door, plexiglass window, laying nest, roost, roofing felt and fitting kit



26.0068

Ancona - Chicken Coop, with Drawer

Dimensions: L250xD100xH170cm

Impregnated spruce

Including coop door, plexiglass window, laying nest, roost, roofing felt and fitting kit



26.0063

Bielefelder - Chicken Coop

Dimensions: L302xD90xH180cm

Impregnated spruce

Including coop door, plexiglass window, laying nest, roost, roofing felt and fitting kit





All our furniture, manufactured using various materials, guarantee both comfort and a warm look and feel. Due to the wide range, there is always something suitable for your garden. Our heaters are also a real asset during cold evenings.



31.0736

Wicker lounge set Hamilton, grey melange

This set consists of:

- 1 Bench L228xP89xH58cm
- 2 Chairs L113xW89xH58cm with armrest (W22cm)
- 1 Table L128xW68xH27cm with glass top
- 1 Table L62xW86xH48cm with glass top
- 1 Side table L48xW48xH48cm
- Charcoal cushions (320 g/m² fabric)
- Flat wicker version



31.0734

Wicker lounge set Nashville, deluxe, grey melange

This set consists of:

- 1 Bench L220xP90xH75cm
- 1 Bench L160xP90xH75cm
- 1 Chairs L110xW90xH75cm
- 1 Table L120xW60xH28cm with black glass top
- 1 Side table L45xW45xH45cm with black glass top
- Charcoal cushions (320 g/m² fabric)
- Flat wicker version

WICKER GARDEN FURNITURE

Maintenance free and available in a wide range of colours has made this style of furniture sets enormously popular. The frame is fabricated from powder-coated aluminium with fully welded connections.

The synthetic wicker/poly-rattan is braided directly onto the frame. What's more, the cushions are of excellent quality, and have an above average thickness of material and a "full-sponge" filling with a high density of 25 kg/m².

**31.0730****Wicker lounge set Long Beach, light brown**

This set consists of:

- 2 Corner element W82xD82xH67cm
- 1 Intermediate element W70xD82XH67cm
- 2 Armchair W94xD82XH67cm
- 2 Table/Ottoman W70xD70xH30cm with glass top
- Beige-grey cushions (320 g/m² fabric)
- Half-round wicker version

**31.0731****Wicker lounge set Damascus, dark brown**

This set consists of:

- 2 Corner element W82xD82xH67cm
- 1 Intermediate element W70xD82XH67cm
- 2 Armchair W94xD82XH67cm
- 2 Table/Ottoman W70xD70xH30cm with glass top
- Beige-grey cushions (320 g/m² fabric)
- Half-round wicker version

**31.0732****Wicker lounge set Bakersfield, black**

This set consists of:

- 2 Corner element W82xD82xH67 cm
- 1 Intermediate element W70xD82xH67cm
- 2 Armchair W94xD82XH67cm
- 2 Table/Ottoman W70xD70xH30cm with glass top
- Light grey cushions (320 g/m² fabric)
- Half-round wicker version

**31.0733****Wicker lounge set Glendale, grey melange**

This set consists of:

- 2 Corner element W82xD82xH67cm
- 1 Intermediate element W70xD82XH67cm
- 2 Armchair W94xD82xH67cm
- 2 Table/Ottoman W70xD70xH30cm with glass top
- Charcoal cushions (320 g/m² fabric)
- Half-round wicker version

**31.0320****Wicker lounge set Oakland, light brown**

This set consists of:

- 1 Corner element W87xD87xH67cm
- 2 Corner element with armrests W140xD87xH67cm
- 2 Intermediate elements W74xD87xH67cm
- 1 Armchair W92xW87xH67cm
- 1 Table W127xD77xH31cm with glass top
- 1 Side table W45xD45xH45cm with glass top
- Beige-grey cushions (320 g/m² fabric)
- Half-round wicker version

**31.0321****Wicker lounge set Daytona, dark brown**

This set consists of:

- 1 Corner element W87xD87xH67cm
- 2 Corner element with armrests W140xD87xH67cm
- 2 Intermediate elements W74xD87xH67cm
- 1 Armchair W92xW87xH67cm
- 1 Table W127xD77xH31cm with glass top
- 1 Side table W45xD45xH45cm with glass top
- Beige-grey cushions (320 g/m² fabric)
- Half-round wicker version

**31.0322****Wicker lounge set Belmont, black**

This set consists of:

- 1 Corner element W87xD87xH67cm
- 2 Corner element with armrests W140xD87xH67cm
- 2 Intermediate elements W74xD87xH67cm
- 1 Armchair W92xW87xH67cm
- 1 Table W127xD77xH31cm
- 1 Side table W45xD45xH45cm
- Light grey cushions (320 g/m² fabric)
- Flat wicker version

**31.0323****Wicker lounge set Greenwood, grey melange**

This set consists of:

- 1 Corner element W87xD87xH67cm
- 2 Corner element with armrests W140xD87xH67cm
- 2 Intermediate elements W74xD87xH67cm
- 1 Armchair W92xW87xH67cm
- 1 Table W127xD77xH31cm
- 1 Side table W45xD45xH45cm
- Charcoal cushions (320 g/m² fabric)
- Flat wicker version

**31.0735****Wicker lounge set Richmond, black**

This set consists of:

- 2 Corner element L79xD79xH70cm
- 1 Middle element L62xD79xH70cm
- 1 Armchair L86xD79xH70cm
- 1 Table L100xD60xH35cm with 1 glass top
- Light grey cushions (320 g/m² fabric)
- Flat wicker version

**NEW****31.0640****Textilene lounge set Buffalo, white**

This Quickdry set consists of:

- 1 3-seater bench L195xW75xH64.3cm
- 2 Armchairs L75xW75xH54.5cm
- 1 Table L130xW64xH32.5cm
- Aluminium frame with a white powder coating
- Light grey cushions
- Weather resistant with Quickdry® foam filling

**31.0706****Wicker dinner set Springfield, deluxe, black**

This set consists of:

- 1 Table W200xD110xH75cm
- 6 Chairs W62xD54xH64cm
- Light grey cushions (320 g/m² fabric)
- Flat wicker version

**NEW****31.0620****Textilene dinner set Montgomery, white**

This Quick-Dry set consists of:

- 1 Table L200xW100xH75cm
- 6 Chairs W56xD60xH90cm
- Aluminium frame with a white powder coating
- Table features ceramic glass
- Light grey cushions
- Weather resistant with Quickdry® foam filling

MODULAR GARDEN FURNITURE

With these unique modular pieces you can put together a lounge set, exactly the way you want it. All the units can be ordered separately.



Wicker Lounge set Golden Gate, grey melange

Flat wicker version

- 31.0770** Wicker armchair Golden Gate, grey melange
Dimensions: W120xD105xH67cm
Charcoal cushion (320 g/m² fabric)
- 31.0771** Wicker intermediate element Golden Gate, grey melange
Dimensions: W70xD95xH67cm
Charcoal cushion (320 g/m² fabric)
- 31.0772** Wicker corner element Golden Gate, grey melange
Dimensions: W95xD95xH67cm
2 charcoal cushion (320 g/m² fabric)
Can be used both left and right
- 31.0773** Wicker table Golden Gate, grey melange
Dimensions: W95xD95xH67cm
With glass top
- 31.0774** Wicker table/hocker Golden Gate, grey melange
Dimensions: W70xD70xH30cm
With glass top and charcoal cushion



Textilene lounge set Colorado Springs, light grey

Aluminium frame with a white powder coating.
Weather resistant with Quickdry® foam filling.

- 31.0600** Textilene armchair Colorado Springs
Incl. metal butler tray
Dimensions: W87xD85xH68cm
- 31.0601** Textilene 2-seater corner coach left Colorado Springs incl. metal butler tray
Dimensions: L160xW83.5xH80cm
- 31.0602** Textilene 2-seater corner coach right Colorado Springs incl. metal butler tray
Dimensions: L160xW83.5xH80cm
- 31.0603** Textilene table Colorado Springs
Incl. metal butler tray
Dimensions: L86.5xW86.5xH43.5cm
- 31.0604** Textilene corner couch Colorado Springs
Dimensions: L83.5xW83.5xH80cm
- 31.0605** Textilene middle couch Colorado Springs
Dimensions: L67.5xW83.5xH80cm
- 31.0606** Textilene footstool/ottoman Colorado Springs
Dimensions: L65xW65xH43.5cm
- 31.0607** Set round tables Colorado Springs
White aluminium
Dimensions: Ø52xH51cm and Ø44xH44cm



Teak lounge set Riverside

Equipped with modular teak elements

- 31.2040** Teak armchair Riverside
Dimensions (incl. cushion):
W81xD80xH82cm
Cushions: charcoal
- 31.2041** Teak 2-seater bench Riverside
Dimensions (incl. cushion):
W150xD80xH84cm
Cushions: charcoal
- 31.2042** Teak 3-seater bench Riverside
Dimensions (incl. cushion):
W220xD80xH83cm
Cushions: charcoal
- 31.2043** Teak table with glass top Riverside
Dimensions: L100xW80xH39cm
- 31.2044** Teak side bench Riverside
Dimensions: L110xW35xH45.5cm



**31.2023****Lounge set 'Grey Yourself'**

Consisting of:

1 Table L170xW73xH50cm

1 Bench L198xW74xH82cm

2 Chairs L88xW74xH82cm

Seat height: 37cm

Wood thickness: 1.6cm

4 tins of scaffolding wood stain Greywash

Fitting kit

Excluding cushions

**31.2025****Dining set 'Grey Yourself'**

Consisting of:

1 Table L250xW105xH75cm

6 Chairs L59xW59xH85cm

Seat height: 43cm

Wood thickness: 1.6cm

4 tins of scaffolding wood stain Greywash

Fitting kit

Excluding cushions

**31.5020****Ice trolley "Keep it cool"**

Dimensions: W78/91xT39xH35/78.5cm

Stainless steel, with plastic isolated inside, bottle opener, icewater valve and on wheels

Fill up the Trolley with ice and keep your drinks and barbecue meat cool!



**31.0701****Wicker dinner set Lexington, light brown**

This set consists of:

6 adjustable chairs with gas strut W76xD60xH112cm

Table with inlay black glass tops L200xW100xH74cm

Black cushions (320 g/m² fabric)

Half-round wicker version

**31.0702****Wicker dinner set Davenport, dark brown**

This set consists of:

6 adjustable chairs with gas strut W76xD60xH112cm

Table with inlay black glass tops L200xW100xH74cm

Beige-grey cushions (320 g/m² fabric)

Half-round wicker version

**31.0703****Wicker dinner set Beverly, black**

This set consists of:

6 adjustable chairs with gas strut W76xD60xH112cm

Table with inlay black glass tops L200xW100xH74cm

Light grey cushions (320 g/m² fabric)

Flat wicker version

**31.0704****Wicker dinner set Grantsville, grey melange**

This set consists of:

6 adjustable chairs with gas strut W76xD60xH112cm

Table with inlay black glass tops L200xW100xH74cm

Charcoal cushions (320 g/m² fabric)

Flat wicker version

**31.0707****Wicker picnic set Sacramento, grey melange**

This set consists of:

2 Benches B169xD44xH51cm

1 Table B200xD94xH72cm with glass top

Charcoal cushions (320 g/m² fabric)

Flat wicker version

**31.0705****Wicker picnic/dinner set Augusta 1, grey melange**

This set consists of:

2 Benches B127xD50xH72cm

1 Table B140xD120xH79cm with glass top

Charcoal cushions (320 g/m² fabric)

Flat wicker version

**31.0709****Wicker picnic/dinner set Augusta 2, grey melange**

This set consists of:

2 Benches B119xD50xH36cm

1 Table B137xD106xH75cm with glass top and wheels

Charcoal cushions (320 g/m² fabric)

Flat wicker version

**31.0740****Wicker lounge set Lancaster, grey melange**

This set consists of:

2 Loungers W184xH56xL66cm

1 Table D40xW40xH35cm

Including charcoal cushions (320 g/m² fabric)

Flat wicker version

**31.0760****Wicker bar set Lincoln, light brown**

This set consists of:

6 Bar stools W41xD50xH99cm

1 Table L160xW75xH115cm with inlay black glass tops

Beige-grey cushions (320 g/m² fabric)

Half-round wicker version

**31.0761****Wicker bar set Danville, dark brown**

This set consists of:

6 Bar stools W41xD50xH99cm

1 Table L160xW75xH115cm with inlay black glass tops

Beige-grey cushions (320 g/m² fabric)

Half-round wicker version

**31.0762****Wicker bar set Baltimore, black**

This set consists of:

6 Bar stools W41xD50xH99cm

1 Table L160xW75xH115cm with inlay black glass tops

Light grey cushions (320 g/m² fabric)

Half-round wicker version

**31.0763****Wicker bar set Green Valley, grey melange**

This set consists of:

6 Bar stools W41xD50xH99cm

1 Table L160xW75xH115cm with inlay black glass tops

Charcoal cushions (320 g/m² fabric)

Half-round wicker version



31.2037

Teak garden set Wellington, black steel

This set consists of:

Dimensions table: L180xD90xH76cm

Dimensions benches: L120xD40xH48cm



31.2004

Teak bar set Buckingham

This set consists of:

6 Bar stools W50xD45/57xH100cm

Seat height: 75cm

1 Bar table L180xW80xH115cm

Wood thickness tabletop and seating: 3.0cm

Including fitting kit



31.0211

Teak bar set Sutton, stainless steel

This set consists of:

1 Table L120xW80xH114cm

4 Bar stools D38xW38xH117cm

Table fitted with 2 black inlay stone plates

Stainless steel legs version



31.0708

Aluminium dinner set Memphis, deluxe, white

This set consists of:

1 Table L200xD100xH75cm with polywood tabletop

8 Chairs D57xW59xH87cm



Teak garden table Modern

Excluding chairs



31.02515 Teak garden table Modern
L180xW90xH78cm

31.02512 Teak garden table Modern
L250xW100xH78cm

31.02518 Teak garden table Modern
L300xW100xH78cm



Teak garden table Rustiek

The description Rustiek for the rustic tables means that they are treated to look 'antique'.

The table tops contain planks that vary in width so that each table is unique.

Excluding chairs



31.02514 Teak garden table Rustic
L180xW90xH78cm

31.02513 Teak garden table Rustic
L250xW100xH78cm

31.02516 Teak garden table Rustiek
L300xW100xH78cm



31.02519

Teak garden table Solid Rustic L400xW100xH78cm

The description Rustic for the rustic tables means that they are treated to look 'antique'. The table tops contain planks that vary in width so that each table is unique.

Excluding chairs



Teak garden table Rustiek with cross legs

The description Rustiek for the rustic tables means that they are treated to look 'antique'.

The table tops contain planks that vary in width so that each table is unique.

Excluding chairs



31.02521 Teak garden table Rustic
L250xW100xH78cm

31.02522 Teak garden table Rustic
L350xW100xH78cm



31.08010
Wicker chair Lamesa, light brown
 Dimensions: W74.5xD60xH89cm
 Including beige-grey cushion
 (320 g/m² fabric)
 Half-round wicker version



31.08013
Wicker chair Lafayette, light brown
 Dimensions: W76xD60xH112cm
 Chair is adjustable
 Including beige-grey cushion
 (320 g/m² fabric)
 Half-round wicker version



31.08011
Wicker chair Danburry, dark brown
 Dimensions: W74.5xD60xH89cm
 Including beige-grey cushion
 (320 g/m² fabric)
 Half-round wicker version



31.08014
Wicker chair Darlington, dark brown
 Dimensions: W76xD60xH112cm
 Chair is adjustable
 Including beige-grey cushion
 (320 g/m² fabric)
 Half-round wicker version



31.08012
Wicker chair Georgetown, grey melange
 Dimensions: W74.5xD60xH89cm
 Including charcoal cushion
 (320 g/m² fabric)
 Flat wicker version



31.08015
Wicker chair Gilford, grey melange
 Dimensions: W76xD60xH112cm
 Chair is adjustable
 Including charcoal cushion
 (320 g/m² fabric)
 Flat wicker version



31.02810
Wicker chair Lawrence, deluxe, light brown
 Dimensions: W70xD59xH87cm
 Including beige-grey cushion
 (320 g/m² fabric)
 Half-round wicker version



31.08016
Wicker relax chair Laconia, light brown
 Dimensions: W72xD70xH107cm
 Including beige-grey cushion
 (320 g/m² fabric)
 Half-round wicker version



31.02811
Wicker chair Davidson, deluxe, dark brown
 Dimensions: W70xD59xH87cm
 Including beige-grey cushion
 (320 g/m² fabric)
 Half-round wicker version



31.08017
Wicker relax chair Delafield, dark brown
 Dimensions: W72xD70xH107cm
 Including beige-grey cushion
 (320 g/m² fabric)
 Half-round wicker version



31.02812
Wicker chair Glenwood, deluxe, grey melange
 Dimensions: W70xD59xH87cm
 Including charcoal cushion
 (320 g/m² fabric)
 Half-round wicker version



31.08018
Wicker relax chair Garfield, grey melange
 Dimensions: W72xD70xH107cm
 Including charcoal cushion
 (320 g/m² fabric)
 Half-round wicker version



31.0215

Teak chair Birmingham

Dimensions: W58xD50xH93cm

Seat height: 44cm

Including fitting kit



NEW



31.0218

Teak chair Toledo

Dimensions: W56xD52xH80cm

Seat height: 45cm

Including fitting kit

Seat and back support are made of braided natural fibres

Wicker hanging chair Pisa

Charcoal cushion (320g/m² fabric)

Chain 75cm

31.0420 Wicker hanging chair Pisa

Dimensions: L91xW69xH131cm

31.0421 Steel frame for hanging chair Pisa

Dimensions: L102xB104xH200cm

Including fitting kit



31.0440

Wicker chair Atlantis

Dimensions: L91xB69xH178cm

With revolving base

Charcoal cushion (320g/m² fabric)



Teak sunlounger Wembley

Dimensions: L200xW65xH35cm

- 31.0501 Teak sunlounger Wembley (without cushion)
- 31.0501C Cushion lounger Wembley

Cushions made of water-repellent deluxe fabric "Royal ribbon grey".



Teak lounger Danau

Dimensions: L200xW70/88xH35cm

- 31.0502 Teak lounger Danau (without cushion)
- 31.0502C Cushion lounger Danau

Cushions made of water-repellent deluxe fabric "Royal ribbon grey".



31.0750

Textilene lounger Palm Bay, grey

Dimensions: W130xH20/52xL200cm

Powder-coated steel frame with grey textilene hammock



31.0528

Rocking chair Relax, teak

Dimensions: B60xW51xH108cm

Seat height: 48cm

Height back support: 72cm

Including fitting kit





30.0015

Swing bench, hardwood

Dimensions: W175xB120xH230cm

Bench width: 125cm

Including fitting kit

This garden cabinet has been treated with oil.



New

31.0630

Textilene balcony set Fremont, white

This set consists of:

1 Table L60xW50xH50cm

2 Chairs W75xD85xH85cm

Aluminium frame with a white powder coating

Weather resistant with Quickdry® foam filling



31.0720

Wicker loveseat Brentwood, black

Dimensions: L145xW65xH92cm

Including light grey cushion

Flat wicker version



31.0553

Standard Loveseat, hardwood

Dimensions: L164xH85cm

Seat height: 37cm

Including fitting kit

This garden cabinet has been treated with oil.



30.0020
Loveseat Paris
 Impregnated pine
 Dimensions: L175xH90cm
 Including fitting kit



30.0019
Lounge chair Miami
 Impregnated pine
 Dimensions: L74xD90xH93cm
 Including fitting kit



31.0527
Loveseat Relax, hardwood
 Dimensions: L177xD89xH93cm
 Including fitting kit
 This garden cabinet has been treated with oil



Chair Relax, hardwood
 Dimensions:
 W75xD89xH93cm
 Including fitting kit
 This garden cabinet has
 been treated with oil.



31.0525 Chair Relax, hardwood
31.0526 Footstool for chair Relax, hardwood
 Dimensions: W57.5xD55xH31cm



31.0710

Wicker cushion box Brooklyn, black

Dimensions: L168xW80xL80cm

Interior fitted with moisture proof synthetic boards

Including 2 gas struts

Watertight zip-off inner bag

Flat wicker version



Teak cushion box

31.0226 Teak cushion box Large

Dimensions: W120xD45xH60cm

31.0225 Teak cushion box Extra Large

Dimensions: W160xD80xH80cm



Picnic Table

impregnated spruce

Wood thickness: 4.2cm

Including fitting kit

Both seats can be folded



30.0017 Picnic Table Basis

Dimensions: L180xW155xH74cm

Dimensions tabletop: L180xW74.5cm

30.0018 Picnic Table Extra

Dimensions: L200xW155xH74cm

Dimensions tabletop: L200xW74.5cm

30.0003 Picnic Table Excellent

Dimensions: L220xW155xH74cm

Dimensions tabletop: L74.5xW220cm



30.0010

Picnic table Superieur

impregnated spruce

Dimensions: L300xW154xH74cm

Dimensions tabletop: W300xL74.5cm

Wood thickness: 4.2cm

Including fitting kit

Both seats can be folded





30.0004

Picnic table Square, impregnated spruce

Dimensions: L230xW230xH70cm

Dimensions tabletop: L130xW130cm

Wood thickness: 4.5cm

Including fitting kit



30.1004

Picnic table Square, hardwood

Dimensions: L210xW210xH75cm

Dimensions tabletop: L130xW130cm

Wood thickness: 3.0cm

Including fitting kit

This garden cabinet has been treated with oil



30.0013

Picnic table Round, impregnated spruce

Dimensions: Ø219xH73cm

Dimensions tabletop: Ø119cm

Wood thickness: 4.5cm

Including fitting kit



NEW



30.1005

Picnic tables Rondo, hardwood

Dimensions: Ø213xH77cm

Dimensions tabletop: Ø115cm

Dimensions of seat: Ø35xH47cm

Wood thickness: 3.5cm

Including fitting kit



30.0027

Picnic table Boss, larch/douglas

Dimensions: L250xW180xH75cm

Dimensions tabletop: L250xW80cm

Wood thickness: 4.5cm

Including fitting kit



30.0044

Picnic table Classic, larch/douglas

Dimensions: L180xW155xH75cm

Dimensions tabletop: L180xW74cm

Wood thickness: 4.2cm

Including fitting kit



NEW



30.0002

Picnic table/bench Vancouver, hardwood

Dimensions: L180xW75xH75cm

Plank thickness: 3cm

Seat/table surface: 40cm

Seat height: 45cm

Table height: 78cm

This multifunctional bench can also be folded out to a half picnic table. With 2 benches you can create a complete picnic set.



31.0561

Teak picnic set Roquefort, deluxe

Dimensions: L200xW100xH75cm

Plank thickness: 3cm

This set comprises 2 separate benches with cross legs

**30.0008****Picnic table Economy, hardwood**

Dimensions: L160xW150xH75cm

Dimensions tabletop: L160xW70cm

Wood thickness: 3.0cm

Including fitting kit

This garden cabinet has been treated with oil

**30.0009****Picnic table Comfort, hardwood**

Dimensions: L180xW160xH75cm

Dimensions tabletop: L180xW76.5cm

Wood thickness: 3.5cm

Including fitting kit

This garden cabinet has been treated with oil

**30.0007****Picnic table Business, hardwood**

Dimensions: L200xW160xH75cm

Dimensions tabletop: L200xW76.5cm

Wood thickness: 3.5cm

Including fitting kit

This garden cabinet has been treated with oil

**30.0022****Picnic table Giant, hardwood**

Dimensions: L250xW160xH75cm

Dimensions tabletop: L250xW76.5cm

Wood thickness: 4.5cm

Including fitting kit

This garden cabinet has been treated with oil



31.2012
Bench Dennebos
 Impregnated pine
 Dimensions: B120xD51xH100cm
 Including fitting kit



31.2013
Bench Sparrenbos
 Impregnated pine
 Dimensions: B175xD80xH100cm
 Including fitting kit



31.0554
Garden bench Nice, hardwood
 Dimensions: B125xD55xH86cm
 Seat height: 44cm
 Including fitting kit
 This garden cabinet has been treated with oil



31.0562
Teak garden bench Roland Garros
 Dimensions: L200xW40cm
 Seat height: 45cm
 Including fitting kit



Teak garden bench Bretagne

Seat height: 44cm

Including fitting kit



- 31.0583** Teak garden bench Bretagne
Dimensions: L120xD51xH91cm
- 31.0585** Teak garden bench Bretagne
Dimensions: L150xD51xH91cm
- 31.0586** Teak garden bench Bretagne
Dimensions: L180xD51xH91cm



Teak garden bench Bretagne

Seat height: 44cm

Including fitting kit



- 31.0587** Teak garden bench Bretagne
Dimensions: L210xD51xH91cm
- 31.0549** Teak garden bench Bretagne
Dimensions: L250xD51xH91cm



Teak park bench Norwich

Seat height: 44 cm

Including fitting kit

Extra thick legs 6.0cm



- 31.0589** Teak park bench Norwich
Dimensions: L180xD51xH91cm



Teak park bench Norwich

Seat height: 44cm

Including fitting kit

Extra thick legs 6.0cm



- 31.0580** Teak park bench Norwich
Dimensions: L210xD51xH91cm
- 31.0581** Teak park bench Norwich
Dimensions: L250xD51xH91cm
- 31.0588** Teak park bench Norwich
Dimensions: L300xD51xH91cm

**31.0001****Tree bench, impregnated pine**

Inner/outer diameter: 87/185cm

Seat height: 46cm

Wood thickness seating: 3.5cm

Including fitting kit

**31.0002****Tree bench, hardwood**

Inner/outer diameter: 69/185cm

Seat height: 46cm

Including fitting kit

This garden cabinet has been treated with oil

**31.0003****Teak tree bench**

Inner/outer diameter: 110/220cm

Seat height: 46cm

Including fitting kit

HARDWOOD & TEAK FURNITURE

Our Teak Furniture is expertly made using top quality Indonesian Teak from approved sources.

Teak possesses natural protective oils, making it weatherproof and ideal for use outdoors. Therefore, it requires no treatment, however, over time, teak wood takes on a natural platinum grey colour due to weather influences, and if necessary, this natural ageing process can be slowed down by regularly treating the wood with one of our specially selected teak oils.

Our Hardwood Furniture is incredibly well made using Indonesian Mahogany Wood, again sourced from approved suppliers and forests.

Our Hardwood Furniture is delivered to you pre-treated with a layer of teak oil, which functions as a first protective layer. When the furniture is to be used for the first time, an extra protective coating should be applied immediately.

Wood is a natural material in which small cracks and some distortion may occur. These are the natural characteristics of wood and does not diminish the quality of the furniture and should be deemed normal.





42.6106

Parasol Le Mans, blue

Dimensions: Ø300cm

6 Ribs

Standard closing mechanism

Powder-coated steel frame, charcoal

Canvas (160gr/m²) treated against UV penetration

Including base for tiles



42.6107

Parasol Le Mans, off-white

Dimensions: Ø300cm

6 Ribs

Standard closing mechanism

Powder-coated steel frame, charcoal

Canvas (160gr/m²) treated against UV penetration

Including base for tiles



42.6108

Parasol Le Mans, charcoal

Dimensions: Ø300cm

6 Ribs

Standard closing mechanism

Powder-coated steel frame, charcoal

Canvas (160gr/m²) treated against UV penetration

Including base for tiles



42.6109

Parasol Le Havre, charcoal

Dimensions: Ø350cm

8 Ribs

De Luxe closing mechanism

Powder-coated aluminium frame charcoal

Canvas (250gr/m²) treated against UV penetration

Including base for tiles

360° Adjustable on the base



**42.6111****Parasol Le Havre, off-white**

Dimensions: Ø350cm

8 Ribs

De Luxe closing mechanism

Powder-coated aluminium frame charcoal

Canvas (250gr/m2) treated against UV penetration

Including base for tiles

360° Adjustable on the base

**42.6110****Parasol Brest, charcoal**

Dimensions: 300x400cm

8 Ribs

De Luxe closing mechanism

Powder-coated aluminium frame charcoal

Canvas (250gr/m2) treated against UV penetration

Including base for tiles

360° Adjustable on the base

**42.6112****Parasol Brest, off-White**

Dimensions: 300x400cm

8 Ribs

De Luxe closing mechanism

Powder-coated aluminium frame charcoal

Canvas (250gr/m2) treated against UV penetration

Including base for tiles

360° Adjustable on the base



To ensure that the parasol stays stable, we recommend applying a counterweight of at least 90 kilos on the base. The parasol can stay open up to wind force 3, if the wind is higher please lower the parasol, fold it up and fix to the post.

**31.5001****Heater, wall model**

Dimensions: L70xW14cm

Suitable for indoor and outdoor use

Water-resistant

220-240V 1800W

Single heating element

Stylish and quality design, made from cast aluminium

Halogen/quartz heating element

With remote control

Complete with holder for wall mounting

**31.5002****Heater, ceiling model**

Diameter: 60cm

Suitable for indoor and outdoor use

Water-resistant

220-240V 900/1200W double heating element

Stylish and quality design, made from cast aluminium

Halogen/quartz heating element

With remote control

2 Positions

**31.5006****Heater, standing model**

Height: 160cm

Suitable for indoor and outdoor use

Water-resistant

220-240V 900/1800W double heating element

Stylish and quality design, made from

cast aluminium

Halogen/quartz heating element

With remote control

2 Positions

**31.5007****Heater, hanging/wall model**

Dimensions: L109xW23cm

Suitable for indoor and outdoor use

Water-resistant

220-240V 900/1800W double heating element

Stylish and quality design, made from cast aluminium

Halogen/quartz heating element

With remote control and 5-hour timer

2 Positions

Light-free, therefore no visible radiation (black heat)

Complete with chain for hanging mounting and holder for wall mounting



31.5005

Gas heater, round model

Height: 195cm

Diameter: 40cm

Water-resistant

Stylish and quality design

5 kW flame heater

Including tube, regulator, gas bottle stand and wheels



31.5000

Gas heater, pyramid model

Dimensions: L52.5xW52.5cm

Height: 220cm

Water-resistant

Stylish design, made entirely from stainless steel

10 kW flame heater

Including pipe, regulator, gas bottle stand and wheels





For a more luxurious feel to your garden, you can choose from our wide range of hottubs and saunas. Enjoy your surroundings in total relaxation.



Hottub spruce

Inside Ø190cm
 Outside Ø200cm
 Height, internal 90cm
 Height, external 105cm
 Wood thickness: 42mm

Supplied as construction kit, including:
 Stairs, 5 Benches, wooden covering lid, aluminium wood heater, including pipe and spark guard, safety grill around the heater (internal), easy to empty due to the plug in the floor, luxury finishing of hot tub brim, adjustable stainless steel tightening straps around the hot tub, impregnated beams under the tub

- 43.6190** Hot tub with internal aluminium heater
- 43.6193** Separate internal aluminium heater
- 43.6180** Hot tub with external aluminium heater
- 43.6187** Separate external aluminium heater
- 43.6184** PVC Liner blue for Hot tub
- 43.6196** Ash shovel set for hot tub
- 43.6197** Impregnating oil for hot tub
- 43.6189** Bottle stand for hot tub
- 43.6183** Filter System for hot tub



Filter system



Hot tube deluxe thermal wood

Ø200cm
Height 150 cm
Height of heater pipe 270cm
Supplied mounted

Includes: stairs, charcoal polyester inner box, stainless steel wood heater and heater pipe, thermo cover, LED lamps and bubble system

43.6182 Hob tub deluxe
43.6183 Filter system



Insulated cover

- shortens the heating time up to 2 time
- keeps water warm for up to five times longer
- protects the contents of the tub to the dust and dirt
- is a safe
- is made of weather- and UV resistant material, resistant to sea water and chlorine
- is resistant to mold and hardly ignitable
- grey

WHAT IS THERMAL WOOD?

Thermal Wood is the result of a sustainable and environmentally-friendly process in which only heat is used to enhance the properties of coniferous wood. The thermal treatment of Finnish coniferous wood results in a characteristic brown shaded pattern, giving it a warm and modern appearance.

Moreover, the treatment ensures: increased resistance against moisture, higher level of sustainability (class 2), better shape retention, a light-weight structure.

After some time, you need to treat Thermal wood with oil or stain.

BARREL SAUNA 250/300CM



43.7002 Ø195xL250 cm
43.7003 Ø195xL300cm

Specifications:

- Wood thickness 28/42mm
- Wood type spruce, untreated
- Door height, incl. frame approx. 170cm
- Windows 2 (can be opened)
- Glass double glazing
- Roof covering roof shingles, black
- Fitting kit included
- Wooden floor and foundation included
- Heat-resistant panel for heater included
- Poplar sauna benches included
- Spruce benches outside included

You can choose between an electric or wood Heater for your sauna.
If you opt for a Harvia M3 wood heater, do not forget to order the special exhaust pipe.
If you choose the Harvia Trendy electric heater, you do not need an exhaust pipe, but bear in mind that you need power supply. For the Harvia BC35 230V is sufficient.
Do you want remote control? Then choose for the Harvia Trendy EX with the CF9 control.

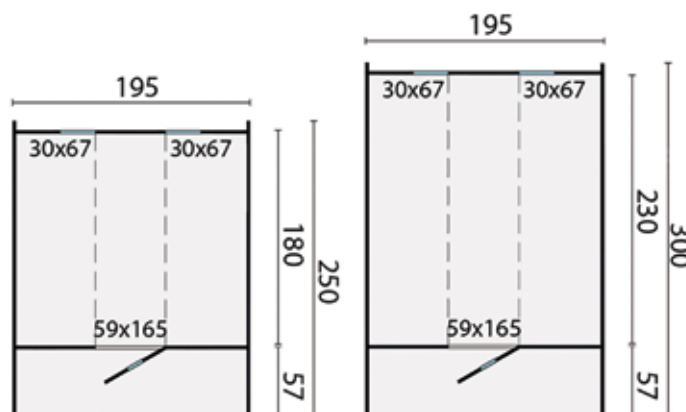

BARREL SAUNA 350/400CM



43.7004 Ø215xL350 cm
43.7005 Ø215xL400 cm

Specifications:

- Wood thickness 28/42mm
- Wood type spruce, untreated
- Door height, incl. frame approx. 170cm
- Windows 2 (can be opened)
- Glass double glazing
- Roof covering roof shingles, black
- Fitting kit included
- Wooden floor and foundation included
- Heat-resistant panel for heater included
- Poplar sauna benches included
- Spruce benches outside included

You can choose between an electric or wood Heater for your sauna.
If you opt for a Harvia M3 wood heater, do not forget to order the special exhaust pipe.
If you choose the Harvia Trendy electric heater, you do not need an exhaust pipe, but bear in mind that you need power supply. For the Harvia BC35 230V is sufficient.
Do you want remote control? Then choose for the Harvia Trendy EX with the CF9 control.

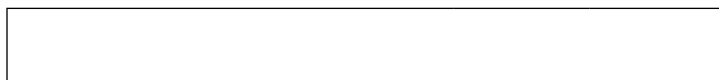
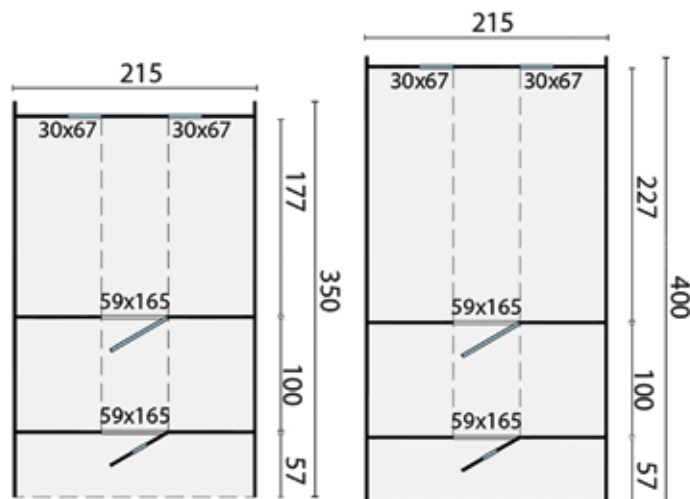

SAUNA 28/42 MM OVAL



Sauna Oval

Specifications:

- Article no..... 43.7025
- Wood thickness 28/42mm
- Wood type spruce, untreated
- Dimensions..... 405x240cm
- Foundation size 190x220cm
- Ridge height approx. 216cm
- Door height, incl. frame approx. 190cm
- Windows 1 (can be opened)
- Glass double glazing
- Roof covering roof shingles, black
- Fitting kit included
- Wooden floor and foundation included
- Poplar sauna benches included
- Spruce benches and table outside, Spruce bench inside..... included

You can choose between an electric or wood Heater for your sauna.
 If you opt for a Harvia M3 wood heater, do not forget to order the special exhaust pipe.
 If you choose the Harvia Trendy electric heater, you do not need an exhaust pipe, but bear in mind that you need power supply. For the Harvia BC35 230V is sufficient.
 Do you want remote control? Then choose for the Harvia Trendy EX with the CF9 control.

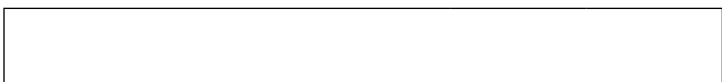
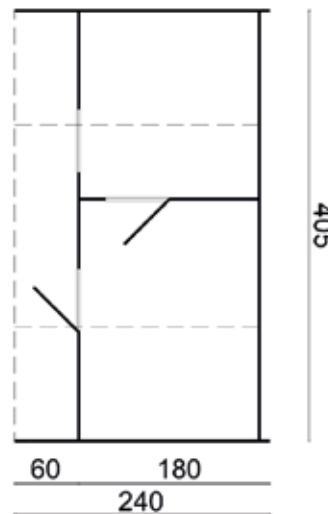

**43.5005
Harvia BC35**

Heater for the dry Finnish family sauna with cubic volume of 2-4.5m³



Built-in electronic control
Heating capacity to 3.5kW
Stainless steel outer casing
The operating panel can be mounted to the left or to the right
Saves space due to wall-mounting
Including 20kg sauna stones
Connection: 230V
Dimensions: L28.0xD29.5xH50.5cm
2-year guarantee



**43.5050
Harvia control CF9**

Size: W18.5xD4.7/5.8xH14.5cm
Basic functions: on/off switch, light switch and temperature adjustment
temperature sensor and overheat protector present
Temperature regulator: 40°-110°C
Heating limited: 6 hours
Switching capacity 9kW
Connection: 400V

**43.5051
Harvia Trendy X heater 8kW**

Size: W41xD28xH60cm
Heater for dry Sauna with a cubic volume of 8m³-14m³
Inclusive: thermostat, timer, connection panel on the bottom, built-in electronic control and sauna stones
Connection: 400V
Heating capacity max. 9kW
Saves space due to wall-mounting
2-year guarantee



**43.5101
Sauna accessory set**

This set consists of:
Pouring spoon
Thermometer / humidity meter
Hourglass
Wooden bucket with plastic interior (4L)

**43.5049
Harvia Trendy XE heater 8kW for external control**

Size: W41xD28xH60cm
Heater for dry Sauna with a cubic volume of 8m³-14m³
Inclusive: connection panel on the bottom and sauna stones
Connection: 400V
Heating capacity max. 9kW
Saves space due to wall-mounting
Exclusive control CF9
2-year guarantee



**43.5103
Standard Sauna Lamp**

Incandescent lamp
Bullseye lamp
Protection





43.5004
Harvia M3 wood heater
 The classic black wood heater with stainless steel air vent system
 Dimensions: L39.0xD43.0xH71.0cm
 Sauna volume 4.5-13m³
 Graphite-black coated
 Including 40kg sauna stones
 2-year guarantee



43.5117
Protective mantel for Harvia M3 wood heater



43.5112
Metal floor board for Harvia M3 wood heater



43.5137
Gabion for Harvia M3 wood heater



43.5105
Exhaust pipe for Harvia M3 wood heater
 Length 250cm, of which 150cm double-walled and 100cm single-walled
 Including rain cap and roof duct





An arbour or veranda is an attractive feature in the garden, it protects you and your furniture from the weather and considerably increases the length of time you can spend in your garden throughout the year. An excellent solution for those who like to spend time outdoors.



Shade canvas, triangle

Open woven canvas 320 g/m²

- 42.423G** Shade canvas, triangle 420x420cm silver grey
- 42.423Z** Shade canvas, triangle 420x420cm sandy beige
- 42.553G** Shade canvas, triangle 550x550cm silver grey
- 42.553Z** Shade canvas, triangle 550x550cm sandy beige
- 42.57777** Fitting kit for shade canvas, triangle Yellow galvanised
The set consists of:
tensioner, eye bolts and swivel coupling



Shade canvas, square

Open woven canvas 320 g/m²

- 42.424G** Shade canvas, square 420x420cm silver grey
- 42.424Z** Shade canvas, square 420x420cm sandy beige
- 42.554G** Shade canvas, square 550x550cm silver grey
- 42.554Z** Shade canvas, square 550x550cm sandy beige
- 42.424GW** Shade canvas, square 420x420cm silver grey
Watertight canvas 180 g/m². Watertight canvases need to have a pitch of 35 cm per metre.
- 42.424ZW** Shade canvas, square 420x420cm sandy beige
Watertight canvas 180 g/m². Watertight canvases need to have a pitch of 35 cm per metre.
- 42.58888** Fitting kit for shade canvas, square The galvanised set consists of: tensioner, eye bolts, swivel coupling



Arbour Butterfly Large

Frame colour: charcoal

Canvas colour: sandy

42.0265 Butterfly Large 300x300cm

42.0270 Butterfly Extra Large 400x400cm



Sliding canvas

Open woven canvas 220 g/m²

42.600Z Sliding canvas 300x500cm sandy/beige

42.600G Sliding canvas 300x500cm silver/grey

42.600I Sliding canvas 300x500cm ivory

42.59999 Stainless steel fitting kit for sliding canvas

The set consists of:
3 wires with tensioner
eye bolts
swivel coupling

42.59998 Aluminum rail trim for sliding canvas

42.59997 Stainless steel closing system for sliding canvas



45.9019

DIY Supporting structure for sliding canvas larch/ douglas

Dimensions: 510x311cm

Columns 14.5x14.5cm

With props, planed, dried, core-free and top quality
Including fitting kit

You saw everything to size yourself.





Wooden pavilion including canvas roof

Specifications:

Article no.....42.0250
 Wood type impregnated pinewood
 Dimensions 300x300cm
 Columns 6.8x6.8cm
 Ridge height approx. 270cm
 Roof covering white canvas
 Fitting kit included
 Trellis included

Optional extra's

42.0251 - Separate canvas (white)



Medium Arbour

Optional roof shingles, straight (18m²)
 Optional roof shingles, beaver tail (18m²)
 Optional roof shingles, hexagonal (18m²)

Specifications:

Article no..... 42.0125
 Wood type impregnated pinewood
 Dimensions Ø 290cm
 Distance between columns 125cm
 Columns hexagonal Ø 9.5cm
 Ridge height approx. 270cm
 Fitting kit included
 Trellis included
 Side panels included

Optional extra's

Adjustable anti-collapsing anchor (6)
 PVC tube for anti-collapsing anchor (6)
 Quick-drying concrete 25kg (6)
 Roof covering kit (2)

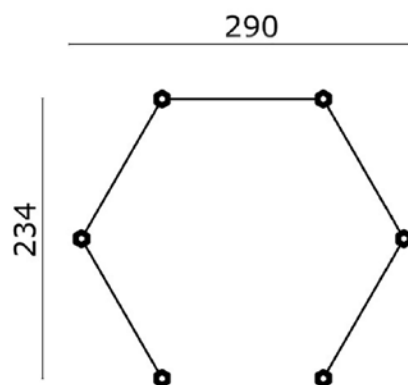



Large Arbour

- Optional roof shingles, straight (21m²)
- Optional roof shingles, beavertail (21m²)
- Optional roof shingles, hexagonal (21m²)

Specifications:

- Article no.....42.0180
- Wood type impregnated pinewood
- Dimensions Ø 400cm
- Distance between columns..... 180cm
- Columns hexagonal Ø 9.5cm
- Ridge height approx. 270cm
- Fitting kit included
- Trellis excluded

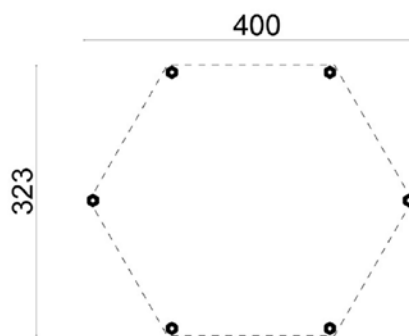

Optional extra's

- Adjustable anti-collapsing anchor (6)
- PVC tube for anti-collapsing anchor (6)
- Quick-drying concrete 25kg (6)
- Trellis, concave frame (6)
- Roof covering kit (2)



Econoom Arbour

- Optional roofing felt (26.5m²)
- Optional roof shingles, straight (21m²)
- Optional roof shingles, beavertail (21m²)
- Optional roof shingles, hexagonal (21m²)

Specifications:

- Article no.....42.3437
- Wood type impregnated pinewood
- Dimensions 340x340cm
- Columns 8.0x8.0cm
- Ridge height approx. 301cm
- Walk-through height approx. 220cm
- Fitting kit included

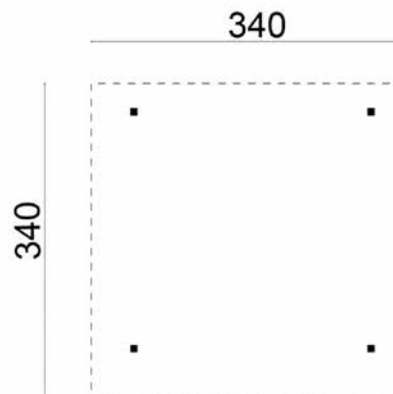

Optional extra's

- Post points, galvanised 9.1x9.1 (4)
- Post supports on panel, galvanised 9.1x9.1 (4)
- Adjustable anti-collapsing anchor (4)
- PVC tube for anti-collapsing anchor (4)
- Quick-drying concrete 25kg (4)
- Gutter set plastic 65mm (charcoal)
- Gutter set plastic 100mm (charcoal)
- Gutter set thermally galvanised 125mm
- Roof covering kit (3)
- Finial with ball



Tourist Arbour
 Optional roof shingles, straight (21m²)
 Optional roof shingles, beavertail (21m²)
 Optional roof shingles, hexagonal (21m²)

Specifications:

Article no.....42.3434
 Wood type impregnated pinewood
 Dimensions 338x338cm
 Columns 11.5x11.5cm
 Ridge height approx. 305cm
 Walk-through height approx. 218cm
 Fitting kit included

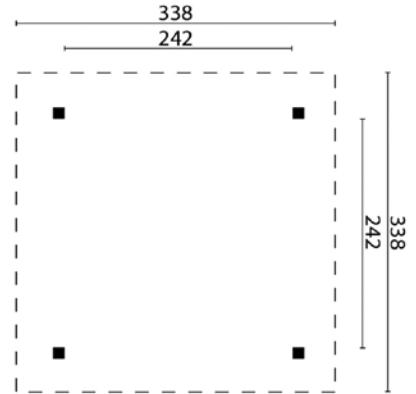

Optional extra's

- Post points, galvanised 12.1x12.1 (4)
- Post supports on panel, galvanised 12.1x12.1 (4)
- Adjustable anti-collapsing anchor (4)
- PVC tube for anti-collapsing anchor (4)
- Quick-drying concrete 25kg (4)
- Gutter set plastic 65mm (charcoal)
- Gutter set plastic 100mm (charcoal)
- Gutter set thermally galvanised 125mm
- Roof covering kit (3)
- Finial with ball



Classico Arbour
 Optional roof shingles, straight (30m²)
 Optional roof shingles, beavertail (30m²)
 Optional roof shingles, hexagonal (21m²)

Specifications:

Article no.....42.4343
 Wood type impregnated pinewood
 Dimensions 430x430cm
 Columns 11.5x11.5cm
 Ridge height approx. 330cm
 Walk-through height approx. 203cm
 Fitting kit included

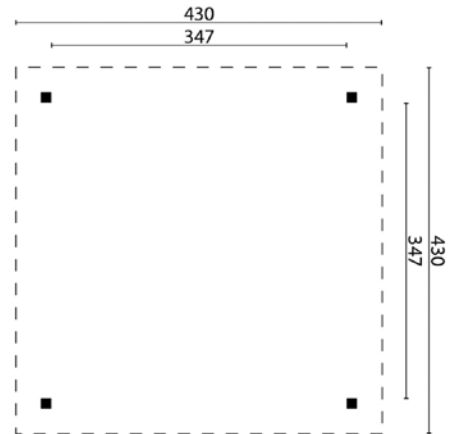

Optional extra's

- Post points, galvanised 12.1x12.1 (4)
- Post supports on panel, galvanised 12.1x12.1 (4)
- Adjustable anti-collapsing anchor (4)
- PVC tube for anti-collapsing anchor (4)
- Quick-drying concrete 25kg (4)
- Gutter set plastic 65mm (charcoal)
- Gutter set plastic 100mm (charcoal)
- Gutter set thermally galvanised 125mm
- Roof covering kit (3)
- Finial with ball



Extremo Arbour
 Optional roof shingles, straight (45m²)
 Optional roof shingles, beavertail (45m²)
 Optional roof shingles, hexagonal (45m²)

Specifications:

Article no.....42.5050
 Wood type impregnated pinewood
 Dimensions560x560cm
 Columns11.5x11.5cm
 Ridge heightapprox. 375cm
 Walk-through heightapprox. 203cm
 Fitting kit included

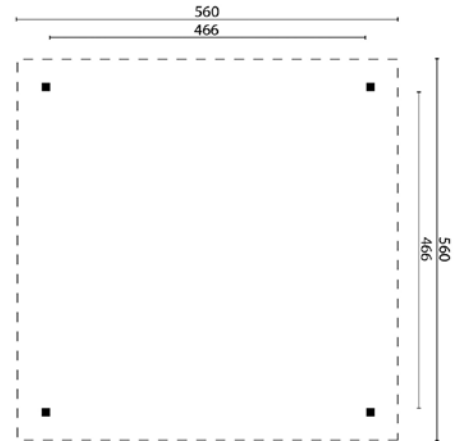

Optional extra's

Post points, galvanised 12.1x12.1 (4)
 Post supports on panel, galvanised 12.1x12.1 (4)
 Adjustable anti-collapsing anchor (4)
 PVC tube for anti-collapsing anchor (4)
 Quick-drying concrete 25kg (4)
 Gutter set plastic 100mm (charcoal)
 Gutter set thermally galvanised 125mm
 Roof covering kit (3)



Grande Arbour
 Optional roof shingles, straight (24m²)
 Optional roof shingles, beavertail (24m²)
 Optional roof shingles, hexagonal (24m²)

Specifications:

Article no.....42.2949
 Wood type impregnated pinewood
 Dimensions490x290cm
 Columns11.5x11.5cm
 Ridge heightapprox. 290cm
 Walk-through heightapprox. 200cm
 Fitting kit included

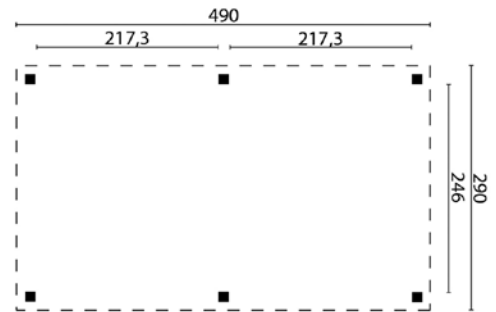

Optional extra's

Post points, galvanised 12.1x12.1 (6)
 Post supports on panel, galvanised 12.1x12.1 (6)
 Adjustable anti-collapsing anchor (6)
 PVC tube for anti-collapsing anchor (6)
 Quick-drying concrete 25kg (6)
 Gutter set plastic 100mm (charcoal)
 Gutter set thermally galvanised 125mm
 Roof covering kit (4)
 Finial with ball (2)



Superieur Arbour
 Optional roof shingles, straight (30m²)
 Optional roof shingles, beavertail (30m²)
 Optional roof shingles, hexagonal (30m²)

Specifications:

Article no.....42.3459
 Wood type impregnated pinewood
 Dimensions594x340cm
 Columns11.5x11.5cm
 Ridge heightapprox. 310cm
 Walk-through heightapprox. 214cm
 Fitting kit included

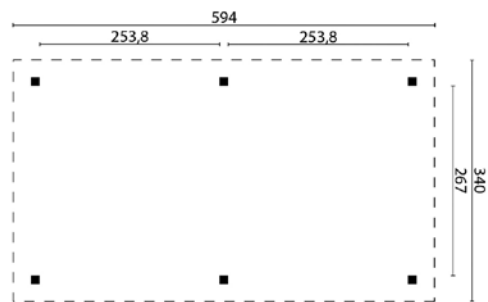

Optional extra's

Post points, galvanised 12.1x12.1 (6)
 Post supports on panel, galvanised 12.1x12.1 (6)
 Adjustable anti-collapsing anchor (6)
 PVC tube for anti-collapsing anchor (6)
 Quick-drying concrete 25kg (6)
 Gutter set plastic 65mm (charcoal)
 Gutter set plastic 100mm (charcoal)
 Gutter set thermally galvanised 125mm
 Roof covering kit (4)
 Finial with ball (2)



Ultimo Arbour
 Optional roof shingles, straight (39m²)
 Optional roof shingles, beavertail (39m²)
 Optional roof shingles, hexagonal (39m²)

Specifications:

Article no.....42.4570
 Wood type impregnated pinewood
 Dimensions700x444cm
 Columns11.5x11.5cm
 Ridge heightapprox. 340cm
 Walk-through heightapprox. 214cm
 Fitting kit included

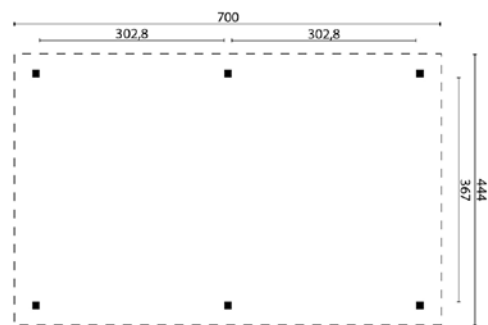

Optional extra's

Post points, galvanised 12.1x12.1 (6)
 Post supports on panel, galvanised 12.1x12.1 (6)
 Adjustable anti-collapsing anchor (6)
 PVC tube for anti-collapsing anchor (6)
 Quick-drying concrete 25kg (6)
 Gutter set plastic 65mm (charcoal)
 Gutter set plastic 100mm (charcoal)
 Gutter set thermally galvanised 125mm
 Roof covering kit (5)
 Finial with ball (2)



Modern Medium Arbour
 Optional roofing felt (16.5m²)
 Optional EASY-roofing (25m²)
 Optional EPDM (18m²)

Specifications:

Article no.....42.3636
 Wood type impregnated pinewood
 Dimensions365x365cm
 Columns11.5x11.5cm
 Ridge heightapprox. 244cm
 Walk-through heightapprox. 229cm
 Fitting kit included

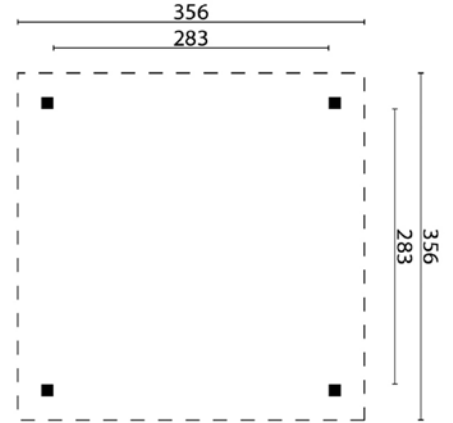

Optional extra's

Post points, galvanised 12.1x12.1 (4)
 Post supports on panel, galvanised 12.1x12.1 (4)
 Adjustable anti-collapsing anchor (4)
 PVC tube for anti-collapsing anchor (4)
 Quick-drying concrete 25kg (4)
 Gutter set plastic 65mm (charcoal)
 Gutter set plastic 100mm (charcoal)
 Gutter set thermally galvanised 125mm
 Roof covering kit (3)
 EPDM Adhesive
 Aluminium Edging Strip (5)
 Aluminium Outer Corner (4)
 Roof Duct, Round



Modern Large Arbour
 Optional roofing felt (26.5m²)
 Optional EASY-roofing (30m²)
 Optional EPDM (23m²)

Specifications:

Article no.....42.4646
 Wood type impregnated pinewood
 Dimensions455x455cm
 Columns11.5x11.5cm
 Ridge heightapprox. 244cm
 Walk-through heightapprox. 229cm
 Fitting kit included

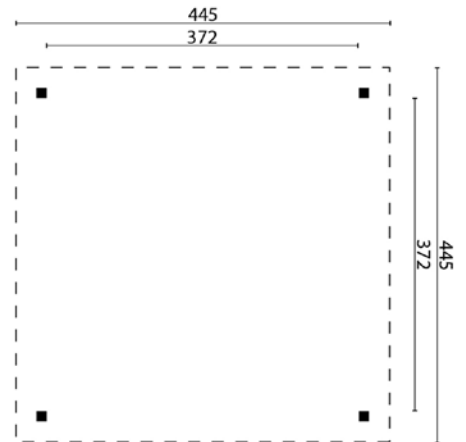

Optional extra's

Post points, galvanised 12.1x12.1 (4)
 Post supports on panel, galvanised 12.1x12.1 (4)
 Adjustable anti-collapsing anchor (4)
 PVC tube for anti-collapsing anchor (4)
 Quick-drying concrete 25kg (4)
 Gutter set plastic 65mm (charcoal)
 Gutter set plastic 100mm (charcoal)
 Gutter set thermally galvanised 125mm
 Roof covering kit (3)
 EPDM Adhesive
 Aluminium Edging Strip (6)
 Aluminium Outer Corner (4)
 Roof Duct, Round



Modern Excellent Rectangular Arbour
 Optional roofing felt (30m²)
 Optional EASY-roofing (25m²)
 Optional EPDM (23m²)

Specifications:

Article no.....42.5934
 Wood type impregnated pinewood
 Dimensions592x340cm
 Columns11.5x11.5cm
 Ridge heightapprox. 225cm
 Walk-through heightapprox. 210cm
 Fitting kit included

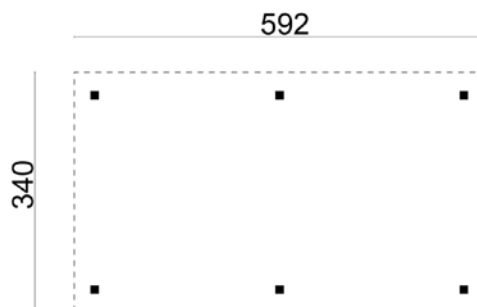

Optional extra's

Post points, galvanised 12.1x12.1 (6)
 Post supports on panel, galvanised 12.1x12.1 (6)
 Adjustable anti-collapsing anchor (6)
 PVC tube for anti-collapsing anchor (6)
 Quick-drying concrete 25kg (6)
 Gutter set plastic 65mm (charcoal)
 Gutter set plastic 100mm (charcoal)
 Gutter set thermally galvanised 125mm
 Roof covering kit (4)
 EPDM Adhesive
 Aluminium Edging Strip (6)
 Aluminium Outer Corner (4)
 Roof Duct, Round



Beerze DIY Arbour
 Without roofing
 Optional EASY-roofing (40m²)
 Optional EPDM (31m²)

Specifications:

Article no.....45.9008B
 Wood type untreated larch/douglas
 Dimensions W620xD520cm
 Columns 15.0x15.0cm
 Ridge heightapprox. 262cm
 Fitting kit included
 DIY.....you saw everything to size yourself
 Unplaned, fresh sawn, core-free, not dried, top quality

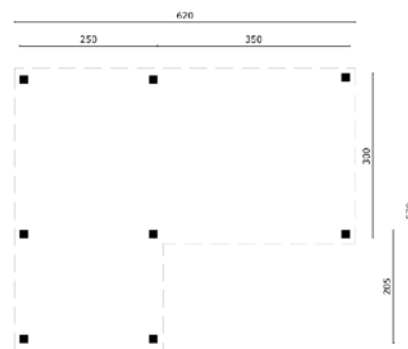

Optional extra's

Aluminium Edging Strip (9)
 Aluminium Outer Corner (5)
 EPDM Adhesive
 Roof Duct, Round (2)
 Concrete Pad Footing with bevelled edges (charcoal) (8)
 Sinking Prevention (8)
 Concrete Pad Footing with rounded edges (grey) (8)
 Concrete Pad Footing with rounded edges (charcoal) (8)
 Thermally Galvanised Height Adjustment (8)
 Stainless steel height adjustment (8)



Kreta Arbour
 Optional roofing felt (16.5m²)
 Optional EASY-roofing (25m²)
 Optional EPDM (18m²)

Specifications:

Article no.....45.3636
 Wood type untreated larch/douglas
 Dimensions 365x365cm
 Columns 11.5x11.5cm
 Ridge height approx. 244cm
 Walk-through height approx. 229cm
 Fitting kit included
 Planed, dried, core-free, top quality

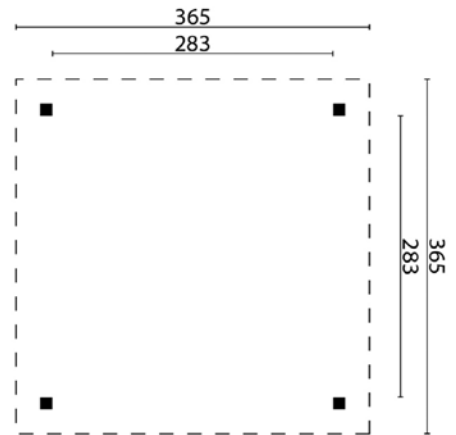

Optional extra's

Post points, galvanised 12.1x12.1 (4)
 Post supports on panel, galvanised 12.1x12.1 (4)
 Adjustable anti-collapsing anchor (4)
 PVC tube for anti-collapsing anchor (4)
 Quick-drying concrete 25kg (4)
 Gutter set plastic 65mm (charcoal)
 Gutter set plastic 100mm (charcoal)
 Gutter set thermally galvanised 125mm
 Roof covering kit (3)
 EPDM Adhesive
 Aluminium Edging Strip (5)
 Aluminium Outer Corner (4)
 Roof Duct, Round



Obdam DIY Arbour
 Without roofing
 Optional roof shingles, straight (30m²)
 Optional roof shingles, beavertail (30m²)
 Optional roof shingles, hexagonal (30m²)

Specifications:

Article no.....45.9018B
 Wood type untreated larch/douglas
 Dimensions 430x430cm
 Columns 15.0x15.0cm
 Ridge height approx. 375cm
 Fitting kit included
 DIY.....you saw everything to size yourself
 Unplaned, fresh sawn, core-free, not dried, top quality

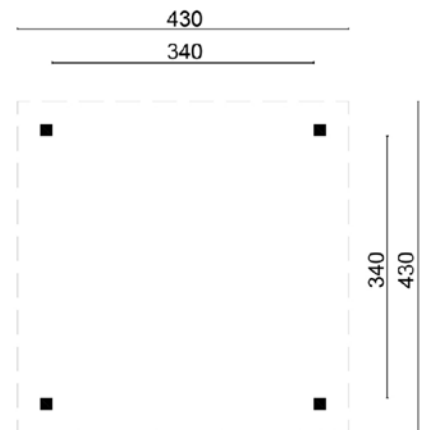

Optional extra's

Concrete Pad Footing with bevelled edges (charcoal) (4)
 Sinking Prevention (4)
 Concrete Pad Footing with rounded edges (grey) (4)
 Concrete Pad Footing with rounded edges (charcoal) (4)
 Thermally Galvanised Height Adjustment (4)
 Stainless steel height adjustment (4)
 Gutter set plastic 65mm (charcoal)
 Gutter set plastic 100mm (charcoal)
 Gutter set thermally galvanised 125mm
 Roof covering kit (3)
 Finial with ball
 Carefree protect (3)



Kos Arbour
 Optional roof shingles, straight (21m²)
 Optional roof shingles, beavertail (21m²)
 Optional roof shingles, hexagonal (21m²)

Specifications:

Article no.....45.3434
 Wood type untreated larch/douglas
 Dimensions 338x338cm
 Columns 11.5x11.5cm
 Ridge height approx. 305cm
 Walk-through height approx. 218cm
 Fitting kit included
 Planed, dried, core-free, top quality

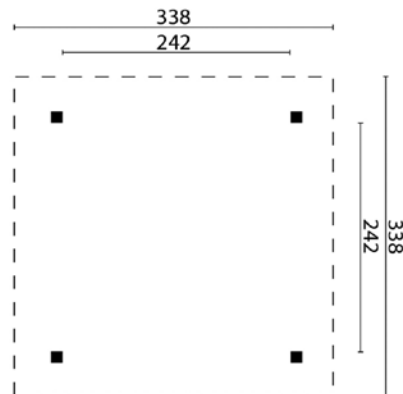

Optional extra's

Post points, galvanised 12.1x12.1 (4)
 Post supports on panel, galvanised 12.1x12.1 (4)
 Adjustable anti-collapsing anchor (4)
 PVC tube for anti-collapsing anchor (4)
 Quick-drying concrete 25kg (4)
 Gutter set plastic 65mm (charcoal)
 Gutter set plastic 100mm (charcoal)
 Gutter set thermally galvanised 125mm
 Roof covering kit (3)
 Finial with ball



Syros Arbour
 Optional roof shingles, straight (30m²)
 Optional roof shingles, beavertail (30m²)
 Optional roof shingles, hexagonal (30m²)

Specifications:

Article no.....45.4343
 Wood type untreated larch/douglas
 Dimensions 430x430cm
 Columns 11.5x11.5cm
 Ridge height approx. 330cm
 Walk-through height approx. 203cm
 Fitting kit included
 Planed, dried, core-free, top quality

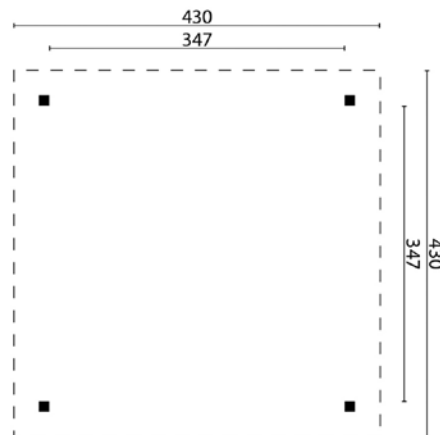

Optional extra's

Post points, galvanised 12.1x12.1 (4)
 Post supports on panel, galvanised 12.1x12.1 (4)
 Adjustable anti-collapsing anchor (4)
 PVC tube for anti-collapsing anchor (4)
 Quick-drying concrete 25kg (4)
 Gutter set plastic 65mm (charcoal)
 Gutter set plastic 100mm (charcoal)
 Gutter set thermally galvanised 125mm
 Roof covering kit (3)
 Finial with ball



Rhodos Arbour

- Optional roof shingles, straight (45m²)
- Optional roof shingles, beavertail (45m²)
- Optional roof shingles, hexagonal (45m²)

Specifications:

Article no.....	45.5050
Wood type	untreated larch/douglas
Dimensions	560x560cm
Columns	11.5x11.5cm
Ridge height	approx. 375cm
Walk-through height	approx. 203cm
Fitting kit	included
Planed, dried, core-free, top quality	

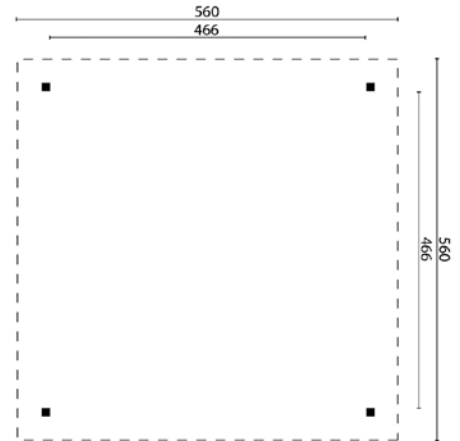

Optional extra's

- Post points, galvanised 12.1x12.1 (4)
- Post supports on panel, galvanised 12.1x12.1 (4)
- Adjustable anti-collapsing anchor (4)
- PVC tube for anti-collapsing anchor (4)
- Quick-drying concrete 25kg (4)
- Gutter set plastic 100mm (charcoal)
- Gutter set thermally galvanised 125mm
- Roof covering kit (3)



Samos Arbour

- Optional roof shingles, straight (24m²)
- Optional roof shingles, beavertail (24m²)
- Optional roof shingles, hexagonal (24m²)

Specifications:

Article no.....	45.2949
Wood type	untreated larch/douglas
Dimensions	490x290cm
Columns	11.5x11.5cm
Ridge height	approx. 290cm
Walk-through height	approx. 200cm
Fitting kit	included
Planed, dried, core-free, top quality	

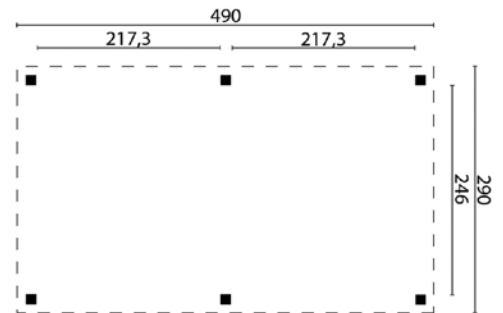

Optional extra's

- Post points, galvanised 12.1x12.1 (6)
- Post supports on panel, galvanised 12.1x12.1 (6)
- Adjustable anti-collapsing anchor (6)
- PVC tube for anti-collapsing anchor (6)
- Quick-drying concrete 25kg (6)
- Gutter set plastic 100mm (charcoal)
- Gutter set thermally galvanised 125mm
- Roof covering kit (4)
- Finial with ball (2)



Corfu Arbour
 Optional roof shingles, straight (30m²)
 Optional roof shingles, beavertail (30m²)
 Optional roof shingles, hexagonal (30m²)

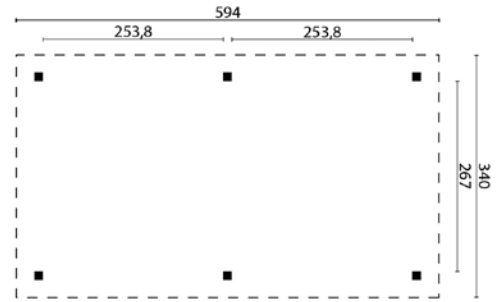

Specifications:

Article no.....45.3459
 Wood type untreated larch/douglas
 Dimensions 590x340cm
 Columns 11.5x11.5cm
 Ridge height approx. 310cm
 Walk-through height approx. 214cm
 Fitting kit included
 Planed, dried, core-free, top quality

Optional extra's

Post points, galvanised 12.1x12.1 (6)
 Post supports on panel, galvanised 12.1x12.1 (6)
 Adjustable anti-collapsing anchor (6)
 PVC tube for anti-collapsing anchor (6)
 Quick-drying concrete 25kg (6)
 Gutter set plastic 100mm (charcoal)
 Gutter set thermally galvanised 125mm
 Roof covering kit (4)
 Finial with ball (2)



Tip
 Place extra walls in your gazebo for extra shade, privacy or for wind protection. See example above to the gazebo Samos lined with larch / douglas pot lids.



Carport Single/extension
Including roofing

Specifications:

Article no.....	41.0002
Wood type	impregnated pinewood
Dimensions	W300xD500cm
Ridge height	approx. 260cm
Drive-through height.....	approx. 230cm
Columns	8.8x8.8x290cm
Snow load.....	100 kg/m2
Roof covering	translucent synthetic roofing sheets
Fitting kit	included

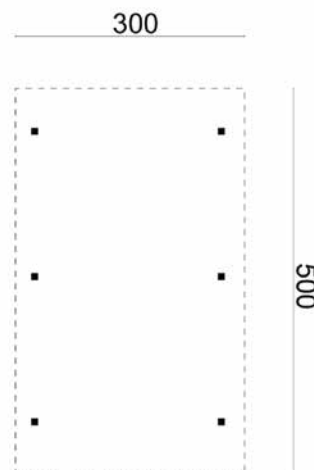

Optional extra's

- Post points, galvanised 9.1x9.1 (6)
- Post supports on panel, galvanised 9.1x9.1 (6)
- Quick-drying concrete 25kg (6)

The upright posts must be dug in to a depth of 60cm or be cut to 230cm.

If built using post points or post supports, the drive-through height can be increased.



Carport Double
Inclusive roofing

Specifications:

Article no.....	41.0003
Wood type	impregnated pinewood
Dimensions	W600xD500cm
Ridge height	approx. 260cm
Drive-through height.....	approx. 230cm
Columns	12.0x12.0x290cm
Snow load.....	100 kg/m2
Roof covering	translucent synthetic roofing sheets
Fitting kit	included

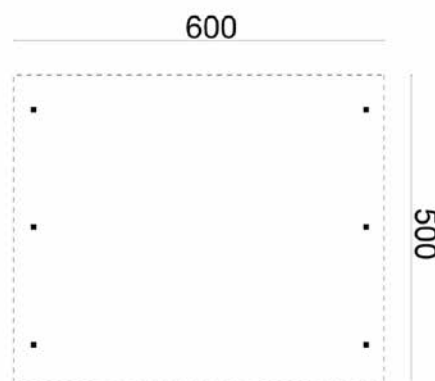

Optional extra's

- Post points, galvanised 12.1x12.1 (6)
- Post supports on panel, galvanised 12.1x12.1 (6)
- Adjustable anti-collapsing anchor (6)
- PVC tube for anti-collapsing anchor (6)
- Quick-drying concrete 25kg (6)

The upright posts must be dug in to a depth of 60cm or be cut to 230cm.

If built using post points or post supports, the drive-through height can be increased.



Sloten Carport
Without roofing
Optional EASY-roofing (25m²)
Optional EPDM (23m²)

Specifications:

Article no..... 45.9015B
Wood type untreated larch/douglas
Dimensions W350xD500cm
Columns 15.0x15.0cm
Ridge height approx. 260cm
Drive-through height..... approx. 230cm
Fitting kit included
DIY.....you saw everything to size yourself
Unplaned, fresh sawn, core-free, not dried, top quality

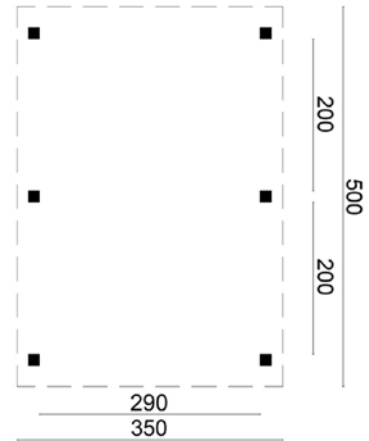

Optional extra's

Roof Duct, Round
Concrete Pad Footing with bevelled edges (charcoal) (6)
Sinking Prevention (6)
Concrete Pad Footing with rounded edges (grey) (6)
Concrete Pad Footing with rounded edges (charcoal) (6)
Thermally Galvanised Height Adjustment (6)
Stainless steel height adjustment (6)
EPDM Adhesive



Lemmer Carport
Without roofing
Optional EASY-roofing (35m²)
Optional EPDM (34m²)

Specifications:

Article no..... 45.9014B
Wood type untreated larch/douglas
Dimensions W450xD600cm
Columns 15.0x15.0cm
Ridge height approx. 260cm
Drive-through height..... approx. 230cm
Fitting kit included
DIY.....you saw everything to size yourself
Unplaned, fresh sawn, core-free, not dried, top quality

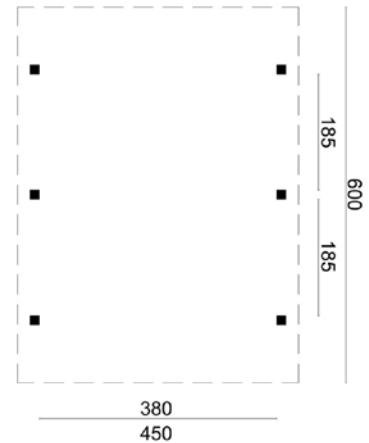

Optional extra's

Roof Duct, Round (2)
Concrete Pad Footing with bevelled edges (charcoal) (6)
Sinking Prevention (6)
Concrete Pad Footing with rounded edges (grey) (6)
Concrete Pad Footing with rounded edges (charcoal) (6)
Thermally Galvanised Height Adjustment (6)
Stainless steel height adjustment (6)
EPDM Adhesive



Workum Carport without roof covering
 Without roofing
 Optional roof shingles, straight (45m²)
 Optional roof shingles, beavertail (45m²)
 Optional roof shingles, hexagonal (45m²)
 Optional roof tile profile boards (39m²)*
 Optional aquapan

Specifications:
 Article no..... 45.9017B
 Wood type untreated larch/douglas
 Dimensions W430xD600cm
 Columns 15.0x15.0cm
 Ridge height approx. 380cm
 Drive-through height..... approx. 230cm
 Fitting kit included
 DIY..... you saw everything to size yourself
 Unplaned, fresh sawn, core-free, not dried, top quality

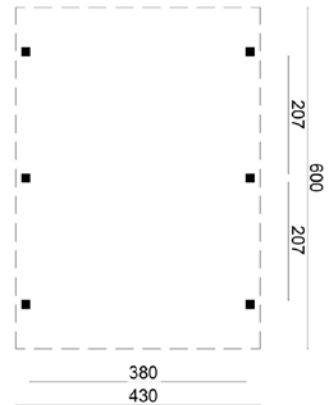

Optional extra's
 Gutter set plastic 65mm (charcoal)
 Gutter set plastic 100mm (charcoal)
 Gutter set thermally galvanised 125mm
 Concrete Pad Footing with bevelled edges (charcoal) (6)
 Sinking Prevention (6)
 Concrete Pad Footing with rounded edges (grey) (6)
 Concrete Pad Footing with rounded edges (charcoal) (6)
 Thermally Galvanised Height Adjustment (6)
 Stainless steel height adjustment (6)
 Carefree protect (3)
 Roof covering kit (3)



Carport , Apex roof
 Optional roof shingles, straight (30m²)
 Optional roof shingles, beavertail (30m²)
 Optional roof shingles, hexagonal (30m²)
 Optional roof tile profile boards (35m²)*
 Optional aquapan

Specifications:
 Article no..... 41.0004
 Wood type impregnated pinewood
 Dimensions 400x600cm
 Ridge height 300cm
 Drive-through height..... approx. 212cm
 Columns 12.0x12.0x220cm
 Fitting kit included

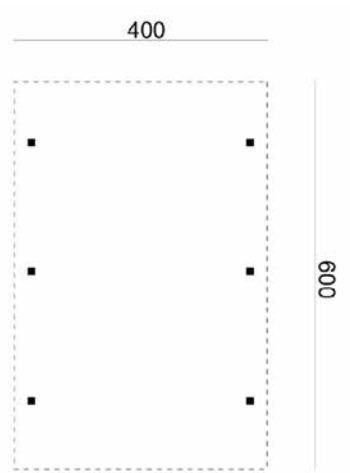

Optional extra's
 Post points, galvanised 12.1x12.1 (6)
 Post supports on panel, galvanised 12.1x12.1 (6)
 Adjustable anti-collapsing anchor (6)
 PVC tube for anti-collapsing anchor (6)
 Quick-drying concrete 25 kg (6)
 Gutter set plastic 100mm (charcoal)
 Gutter set thermally galvanised 125mm
 Gutter plank (impr. Spruce, necessary for fitting a gutter) (4)
 Roof covering kit (3)

MARKETTA - GARAGE



Optional roofing felt (36.5m²)
 Optional EASY-roofing (30m²)
 Optional EPDM (30m²)

Specifications:

Article no..... 40.0797
 Wood thickness 44mm
 Wood type spruce, untreated
 Dimensions..... 380x536cm
 Foundation size 360x516cm
 Ridge height approx. 233cm
 Garage doors..... 2x 110cm
 Windows 2 (can be opened)
 Glass single glazing
 The single door and windows can be placed to the left or to the right.

Optional extra's

Impregnation: Green, Brown, Silver-Grey
 Impregnating Liquid in Green, Brown, Silver-Grey or Transparent (3)
 Spray-applied base coat: White, Grey, Charcoal, Transparent
 Stain (5)
 Carefree protect (5)
 Starter's set (Nails, air vent & storm anchor set)
 Foundation beams, impregnated 300cm (7)
 Foundation beams, hardwood 300cm (7)
 Foundation beams, synthetic 300cm (7)
 Construction girders, hardwood 4.0x20.0x300cm (7)
 Hardwood stakes with point 6.0x6.0x75cm (35)
 Gutter set plastic 100mm (charcoal)
 Gutter set thermally galvanised 125mm
 Roof covering kit (7)
 EPDM Adhesive
 Glazing kit white
 Additional wall layer
 Aluminium Edging Strip (7)
 Aluminium Outer Corner (4)
 Roof Duct, Round (2)

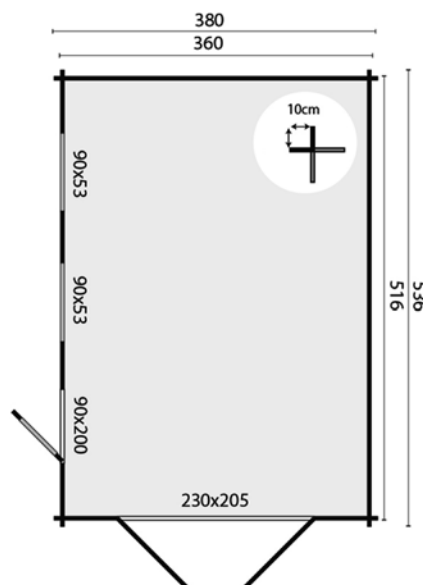

All options can be found from page 399 onwards

17.8m²
 23.4m²
 40.0m³
 44mm
 4mm

GEIR GARAGE



Optional roof shingles, straight (30m²)
 Optional roof shingles, beavertail (30m²)
 Optional roof shingles, hexagonal (30m²)

Optional roof tile profile boards (34m²)*
 Optional aquapan

Specifications:

Article no..... 40.0799
 Wood thickness 44mm
 Wood type spruce, untreated
 Dimensions..... 360x537cm
 Foundation size 340x517cm
 Ridge height approx. 285cm
 Garage doors..... 2x 113cm
 Windows 2 (can be opened)
 Glass single glazing
 Supplied with separate bars for windows and doors.
 The single door and windows can be placed to the left or to the right.
 When using a gutter an extra wall layer is necessary

Optional extra's

- Impregnation: Green, Brown, Silver-Grey
- Impregnating Liquid in Green, Brown, Silver-Grey or Transparent (3)
- Spray-applied base coat: White, Grey, Charcoal, Transparent
- Stain (5)
- Carefree protect (5)
- Starter's set (Nails, air vent & storm anchor set)
- Foundation beams, impregnated 300cm (6)
- Foundation beams, hardwood 300cm (6)
- Foundation beams, synthetic 300cm (6)
- Construction girders, hardwood 4.0x20.0x300cm (6)
- Hardwood stakes with point 6.0x6.0x75cm (30)
- Gutter set plastic 100mm (charcoal)
- Gutter set thermally galvanised 125mm
- Gutter plank (impr. Spruce, necessary for fitting a gutter) (3)
- Skylight (only with roofing felt and roof shingles)
- Roof covering kit (4)
- Glazing kit white
- Additional wall layer
- * Wide wind stop (impregnated spruce) (8)

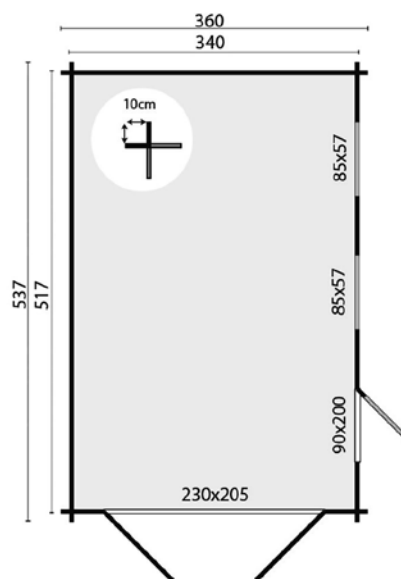

All options can be found from page 399 onwards

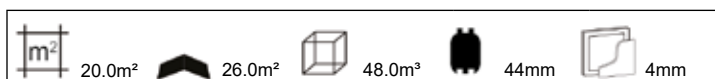

RYDELL GARAGE



Optional roof shingles, straight (36m²)
 Optional roof shingles, beavertail (36m²)
 Optional roof shingles, hexagonal (36m²)

Optional roof tile profile boards (39m²)*
 Optional aquapan

Specifications:

Article no..... 40.0798
 Wood thickness 58mm
 Wood type spruce, untreated
 Dimensions.....470x570cm
 Foundation size450x550cm
 Ridge height approx. 276cm
 Garage doors.....2x 115cm
 Windows 1 (can be opened)
 Glassdouble glazing
 Supplied with separate bars for windows and doors.
 The single door and windows can be placed to the left or to the right.
 When using a gutter an extra wall layer is necessary

Optional extra's

- Impregnation: Green, Brown, Silver-Grey
- Impregnating Liquid in Green, Brown, Silver-Grey or Transparent (3)
- Spray-applied base coat: White, Grey, Charcoal, Transparent
- Stain (6)
- Carefree protect (6)
- Starter's set (Nails, air vent & storm anchor set)
- Foundation beams, impregnated 300cm (7)
- Foundation beams, hardwood 300cm (7)
- Foundation beams, synthetic 300cm (7)
- Construction girders, hardwood 4.0x20.0x300cm (7)
- Hardwood stakes with point 6.0x6.0x75cm (35)
- Gutter set plastic 100mm (charcoal)
- Gutter set thermally galvanised 125mm
- Gutter plank (impr. Spruce, necessary for fitting a gutter) (3)
- Skylight (only with roofing felt and roof shingles)
- Roof covering kit (5)
- Glazing kit white
- Additional wall layer
- * Wide wind stop (impregnated spruce) (8)

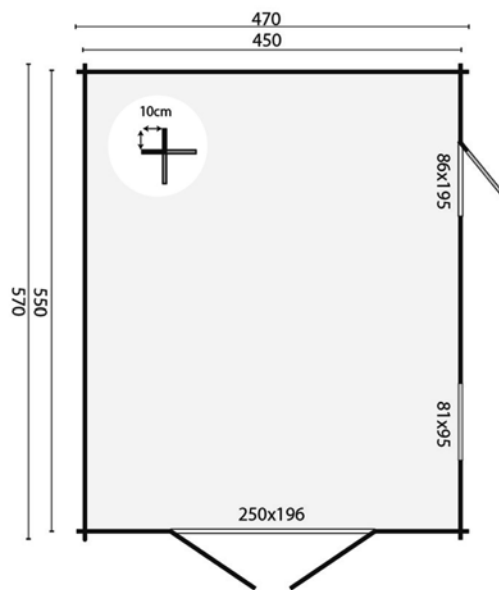

All options can be found from page 399 onwards

m² 24.7m²
30.2m²
61.9m³
58mm
3-12-3 mm

MOA GARAGE



Optional roof shingles, straight (42m²)
 Optional roof shingles, beavertail (42m²)
 Optional roof shingles, hexagonal (42m²)

Optional roof tile profile boards (44m²)*
 Optional aquapan

Specifications:

Article no..... 40.0803
 Wood thickness 44mm
 Wood type spruce, untreated
 Dimensions..... 598x500cm
 Foundation size 578x480cm
 Ridge height approx. 316cm
 Garage doors..... 2x 111cm
 Windows 2 (can be opened)
 Glass single glazing
 When using a gutter an extra wall layer is necessary

Optional extra's

- Impregnation: Green, Brown, Silver-Grey
- Impregnating Liquid in Green, Brown, Silver-Grey or Transparent (4)
- Spray-applied base coat: White, Grey, Charcoal, Transparent
- Stain (8)
- Carefree protect (8)
- Starter's set (Nails, air vent & storm anchor set)
- Foundation beams, impregnated 300cm (9)
- Foundation beams, hardwood 300cm (9)
- Foundation beams, synthetic 300cm (9)
- Construction girders, hardwood 4.0x20.0x300cm (9)
- Hardwood stakes with point 6.0x6.0x75cm (45)
- Gutter set plastic 100mm (charcoal)
- Gutter set thermally galvanised 125mm
- Gutter plank (impr. Spruce, necessary for fitting a gutter) (4)
- Skylight (only with roofing felt and roof shingles)
- Roof covering kit (7)
- Glazing kit white
- Additional wall layer
- * Wide wind stop (impregnated spruce) (8)

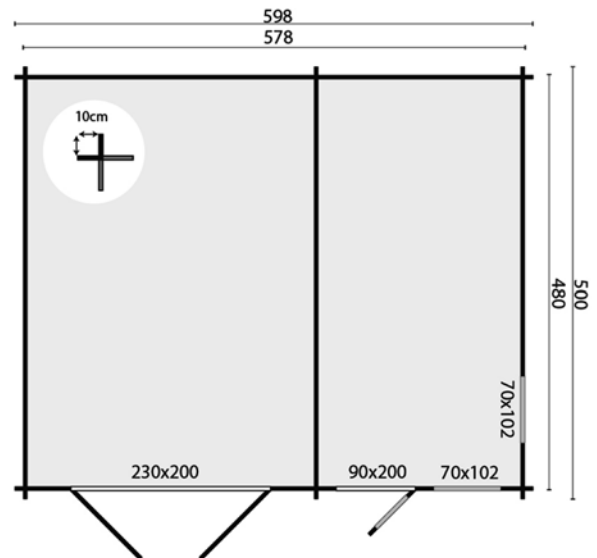

All options can be found from page 399 onwards

	15.5m ² 11.0m ²		37.0m ²		74.2m ³		44mm		4mm
--	--	--	--------------------	--	--------------------	--	------	--	-----

EVER CARPORT/STORAGE

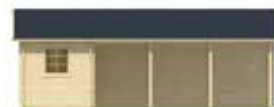

Optional roof shingles, straight (45m²)
 Optional roof shingles, beavertail (45m²)
 Optional roof shingles, hexagonal (45m²)

Optional roof tile profile boards (51m²)*
 Optional aquapan

Specifications:

Article no..... 40.0805
 Wood thickness 44mm
 Wood type spruce, untreated
 Dimensions..... 219+551x430cm
 Foundation..... size 750x410cm
 Ridge height approx. 290cm
 Windows 1 (can be opened)
 Glass single glazing

Optional extra's

- Impregnation: Green, Brown, Silver-Grey
- Impregnating Liquid in Green, Brown, Silver-Grey or Transparent (4)
- Spray-applied base coat: White, Grey, Charcoal, Transparent Stain (7)
- Carefree protect (7)
- Starter's set (Nails, air vent & storm anchor set)
- Foundation beams, impregnated 300cm (7)
- Foundation beams, hardwood 300cm (7)
- Foundation beams, synthetic 300cm (7)
- Construction girders, hardwood 4.0x20.0x300cm (7)
- Hardwood stakes with point 6.0x6.0x75cm (35)
- Gutter set plastic 100mm (charcoal)
- Gutter set thermally galvanised 125mm
- Gutter plank (impr. Spruce, necessary for fitting a gutter) (4)
- Skylight (only with roofing felt and roof shingles)
- Roof covering kit (4)
- Glazing kit white
- Wooden floor 18mm (4)
- Wooden floor 18mm impregnated (4)
- Wooden floor 26mm (5)
- Wooden floor 26mm impregnated (5)
- Additional wall layer
- * Wide wind stop (impregnated spruce) (8)

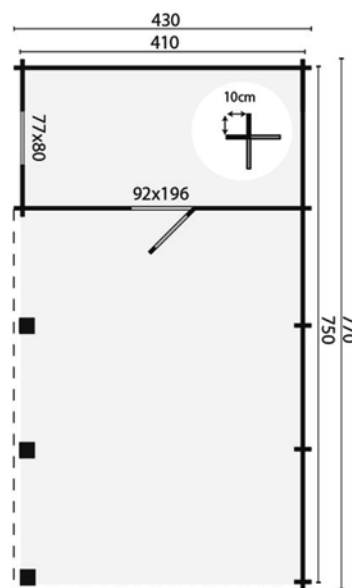

All options can be found from page 399 onwards

8.0m²
22.0m²
42.0m²
20.0m³
44mm
4mm

BERGGREN GARAGE/CARPORT



Optional roof shingles, straight (75m²)
 Optional roof shingles, beavertail (75m²)
 Optional roof shingles, hexagonal (75m²)

Optional roof tile profile boards (75m²)*
 Optional aquapan

Specifications:

Article no..... 40.0796
 Wood thickness 70mm
 Wood type spruce, untreated
 Dimensions..... 396+369x830cm
 Foundation size 376x810cm
 Ridge height approx. 331cm
 Drive-through height..... approx. 220cm
 Garage doors..... 2x 111cm
 Windows 1 (can be opened)
 Glass Double glazing
 Can also be constructed in mirror image.
 Side window can be placed to the left or to the right.

Optional extra's

Impregnation: Green, Brown, Silver-Grey
 Impregnating Liquid in Green, Brown, Silver-Grey or Transparent (6)
 Spray-applied base coat: White, Grey, Charcoal, Transparent
 Stain (12)
 Carefree protect (12)
 Starter's set (Nails, air vent & storm anchor set)
 Foundation beams, impregnated 300cm (9)
 Foundation beams, hardwood 300cm (9)
 Foundation beams, synthetic 300cm (9)
 Construction girders, hardwood 4.0x20.0x300cm (9)
 Hardwood stakes with point 6.0x6.0x75cm (45)
 Gutter set plastic 100mm (charcoal)
 Gutter set thermally galvanised 125mm
 Gutter plank (impr. Spruce, necessary for fitting a gutter) (5)
 Skylight (only with roofing felt and roof shingles)
 Roof covering kit (12)
 Glazing kit white
 Additional wall layer
 * Wide wind stop (impregnated spruce) (9)

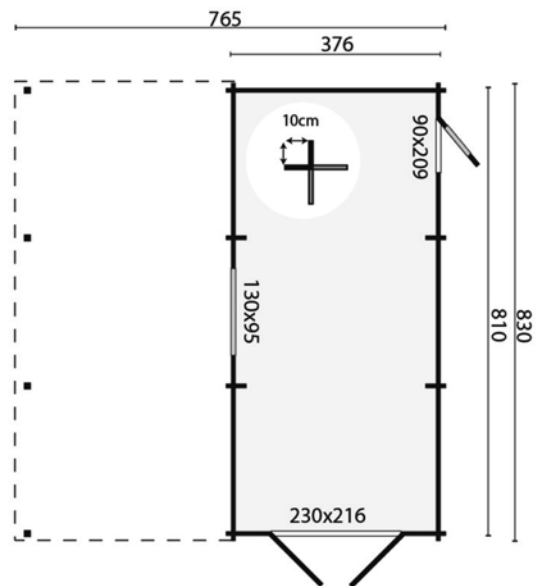

All options can be found from page 399 onwards

30.8m ² 28.4m ²	70.0m ²	86.0m ³	70mm	4-6-4 mm
--	--------------------	--------------------	------	----------

NYSSE GARAGE/OPEN-SIDED BARN



Optional roof shingles, straight (36m²)
 Optional roof shingles, beavertail (36m²)
 Optional roof shingles, hexagonal (36m²)

Optional roof tile profile boards (39m²)*
 Optional aquapan

Specifications:

Article no..... 40.0800
 Wood thickness 70mm
 Wood type spruce, untreated
 Dimensions..... 600x600cm
 Foundation size 580x580cm
 Ridge height approx. 336cm
 Drive-through height..... approx. 208cm

Optional extra's

- Impregnation: Green, Brown, Silver-Grey
- Impregnating Liquid in Green, Brown, Silver-Grey or Transparent (3)
- Spray-applied base coat: White, Grey, Charcoal, Transparent
- Stain (6)
- Carefree protect (6)
- Starter's set (Nails, air vent & storm anchor set)
- Foundation beams, impregnated 300cm (7)
- Foundation beams, hardwood 300cm (7)
- Foundation beams, synthetic 300cm (7)
- Construction girders, hardwood 4.0x20.0x300cm (7)
- Hardwood stakes with point 6.0x6.0x75cm (35)
- Gutter set plastic 100mm (charcoal)
- Gutter set thermally galvanised 125mm
- Gutter plank (impr. Spruce, necessary for fitting a gutter) (4)
- Skylight (only with roofing felt and roof shingles)
- Roof covering kit (4)
- Additional wall layer
- * Wide wind stop (impregnated spruce) (8)

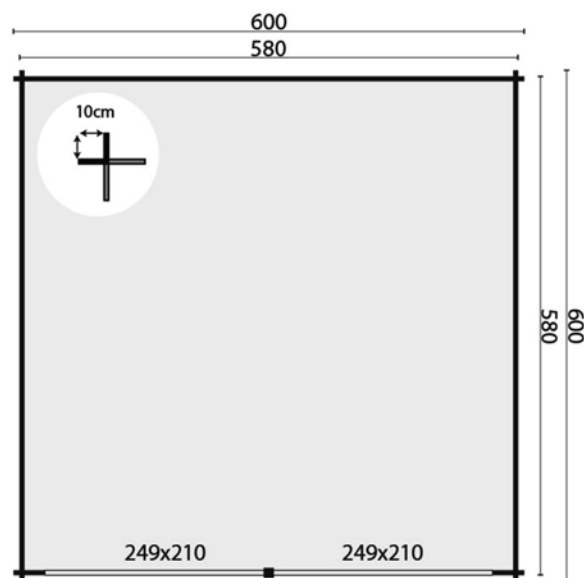

All options can be found from page 399 onwards

	32.0m ²		43.4m ²		96.0m ³		70mm
--	--------------------	--	--------------------	--	--------------------	--	------



VERANDA TYPE EASY

The aluminium verandas with opal polycarbonate roof covering are delivered in the following dimensions:

300x250cm	2 columns
400x250cm	3 columns
500x250cm	3 columns
600x250cm	3 columns
700x250cm	4 columns
300x300cm	2 columns
400x300cm	3 columns
500x300cm	3 columns
600x300cm	3 columns
700x300cm	4 columns

RAL 9016
Standard

RAL 7016 matt
Standard

Select your extra options



Side wall dimensions:

250cm deep	210/250cm high
300cm deep	210/250cm high

Side or front wall Easy incl. glass

To seal your veranda from wind and rain.

Front wall dimensions:

250cm deep	250/250cm high
300cm deep	250/250cm high



LUXURIOUS VERANDA TYPE LEGEND

The aluminium verandas with polycarbonate roof covering are delivered in the following dimensions:

300x250cm	2 columns	300x350cm	2 columns	300x450cm	2 columns
400x250cm	2 columns	400x350cm	2 columns	400x450cm	2 columns
500x250cm	3 columns	500x350cm	3 columns	500x450cm	3 columns
600x250cm	3 columns	600x350cm	3 columns	600x450cm	3 columns
700x250cm	3 columns	700x350cm	3 columns	700x450cm	3 columns
300x300cm	2 columns	300x400cm	2 columns	300x500cm	2 columns
400x300cm	2 columns	400x400cm	2 columns	400x500cm	2 columns
500x300cm	3 columns	700x400cm	3 columns	500x500cm	3 columns
600x300cm	3 columns	600x400cm	3 columns	600x500cm	3 columns
700x300cm	3 columns	700x400cm	3 columns	700x500cm	3 columns

Select your colour

RAL 9016
Standard

RAL 9001
Standard

RAL 7016 texture varnish
Standard

RAL 9007 texture varnish
Standard



Select your roof covering

Standard clear polycarbonate
Allows light through



IR Clear polycarbonate
Clear/greenish in colour, the panel is heat resistant; and keeps heat out. This makes a difference of 8 to 11°C compared to the standard!



Standard opal polycarbonate
Milky white colour



IQ Relax polycarbonate
Milky white colour, the panel is heat-resistant and keeps a lot of heat out. This makes a difference of 8 to 11°C compared to the standard!



Select your extra options



Prop
Stabilises your veranda and gives it a nostalgic look



U-element
Fastening element for foundation on hardened ground



LED lighting Exclusive
Including cable and transformer dimmable with remote control



Post support
For assembly on hard ground



Foundation base with drainage



Foundation base without drainage

Wedge skirt and side wall with polycarbonate

Wedge skirt dimensions:
The maximum height is 98cm
up to 250cm long
up to 300cm long
up to 350cm long
up to 400cm long
up to 450cm long
up to 500cm long



Side wall dimensions:

up to 250cm deep	252/210cm high
up to 300cm deep	266/210cm high
up to 350cm deep	273/210cm high
up to 400cm deep	280/210cm high
up to 450cm deep	287/210cm high
up to 500cm deep	294/210cm high

3 planes
3 planes
4 planes
4 planes
5 planes
5 planes

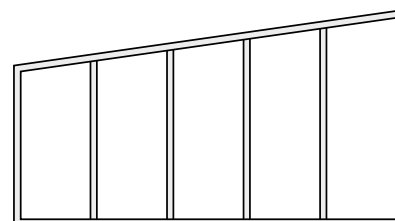



COMPLETE ALUMINIUM SUN ROOM WITH GLASS SLIDING DOORS

The complete aluminium sun rooms are available in the following dimensions:

300x250cm
400x250cm
500x250cm
600x250cm
700x250cm

300x300cm
400x300cm
500x300cm
600x300cm
700x300cm

300x350cm
400x350cm
500x350cm
600x350cm
700x350cm

300x400cm
400x400cm
500x400cm
600x400cm
700x400cm





**DO-IT-YOURSELF VERANDA
UNPLANED LARCH/DOUGLAS**

Unplaned, fresh sawn, core-free, not dried, top quality
Columns 15.0x15.0cm, girders 10.0x20.0cm and 5.0x15.0cm
Including construction instructions, whereby you can customize the structure

Without roofboardstructure

Roofboard, planks 1.8x19.0cm
(additional charge)

Polycarbonate sheets opal, complete set,
including white aluminum profiles
(additional charge)

- 45.9009B B400xD300cm (2 columns)
- 45.9010B B500xD300cm (3 columns)
- 45.9011B B600xD300cm (3 columns)
- 45.9013B B500xD400cm (3 columns)
- 45.9012B B600xD400cm (3 columns)

- 45.9009D
- 45.9010D
- 45.9011D
- 45.9013D
- 45.9012D

- 45.9009P
- 45.9010P
- 45.9011P
- 45.9013P
- 45.9012P

**DO-IT-YOURSELF VERANDA
PLANED LARCH/DOUGLAS**

Planed, dried, core-free, A-grade
Columns 14.5x14.5cm, beams 4.5x14.5cm and 6.5x16.0cm
Including build-up description, where you make everything yourself

Without roofboardstructure

Roofboard, planks 1.8x14.5cm
(additional charge)

Polycarbonate sheets opal, complete set, inclu-
ding white aluminum profiles
(additional charge)

- 45.9022B B400xD300cm (2 columns)

- 45.9022D

- 45.9009P



Options:

- Roof covering (see page 405-407)
- Gutter sets (see page 410)
- Concrete pad footing (see page 414)





GLASS SLIDING WALL SYSTEM FOR LOG CABINS AND COVERS

10mm safety glass

2 Double ball bearing wheels per panel

The glass panels have a standard width of 98cm

Water-draining bottom rail in anodised aluminum

Upper guide rail and 2 wall connection profiles in powder coated anthracite aluminum (RAL 7016)

Standard rail with 4 rails (upon request, for a supplement, also available with 5 or 6 rails)

We recommend a minimum overlap of 2cm per glazing panel

Installation height at least 226cm and at most 231cm

By placing the adjustment frame higher or lower you can bridge about 4cm more or less space

Roofs

Larch/Douglas is logged from well-managed forests and is one of the most durable coniferous wood varieties. It has a warm look with a beautiful colour and structure. Larch/Douglas has a durability rating of 3-4 and has a sturdy look. Over time, it turns grey, giving it a weathered appearance.

You can opt for either the DIY system or the modular system.

New are the roofs of Northern Swedish spruce.

By impregnating and drying these buildings have a solid and sublime fit with little expansion and shrinkage.

The impregnation ensures that these buildings fall into class 3 in terms of durability, so enjoy your product for longer.



Do-it-yourself roofs impregnated spruce and larch/douglas

Our standard Garden Houses with a Flat Roof and Open-Sided Barns are supplied including:

- Full list of materials of standard lengths that you cut to size
- Construction manual
- Pack of screws

Versions:

- Unplaned, untreated Larch/Douglas, fresh sawn, not dried, core-free, top quality (pages 168-169).
Fresh sawn/undried means that the wood dries in a natural manner. As a result, drying cracks may appear, this, however, does not damage the strength and quality of the Larch/Douglas (pages 171-174).
- Planed, untreated Larch/Douglas, dried, core-free, top quality (pages 172, 175-176).

If you wish you can cut all the models to size yourself.

All options and wall modules can be found from page 165 and 219 .





DHZ Plat dak Bastenaken B400xD300xH262cm
 Impregnated Pine.
 DIY - including attachment material
45.9001V Weatherboard profile planks, impregnated
45.9001VZ Weatherboard profile planks, black

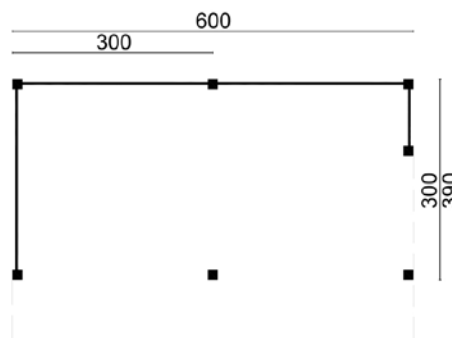

Optional extra's

- Roof shingles, straight (36m²) (12)
- Roof shingles, beavertail (36m²) (12)
- Roof shingles, hexagonal (36m²) (12)
- Roof tile profile boards (30m²) (30)
- Aquapan
- Gutter set plastic 65mm (charcoal)
- Gutter set plastic 100mm (charcoal)
- Gutter set thermally galvanised 125mm

- Concrete pad footing with bevelled edges (charcoal) (7)
- Sinking prevention (7)
- Concrete pad footing with rounded edges (grey) (7)
- Concrete pad footing with rounded edges (charcoal) (7)
- Thermally galvanised height adjustment (7)
- Stainless steel height adjustment (7)
- Roof covering kit (4)



DIY flat roof Bastenaken, plain B400xD300xH262cm
 Impregnated Pine.
 DIY - including attachment material
45.9004V Weatherboard profile planks, impregnated
45.9004VZ Weatherboard profile planks, black

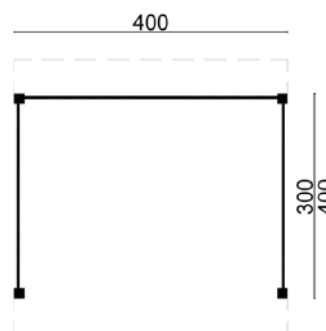

Optional extra's

- Easy-roofing (25m²) (5)
- EPDM (22m²) (22)
- Concrete pad footing with bevelled edges (charcoal) (4)
- Sinking prevention (4)
- Concrete pad footing with rounded edges (grey) (4)
- Concrete pad footing with rounded edges (charcoal) (4)

- Thermally galvanised height adjustment (4)
- Stainless steel height adjustment (4)
- EPDM Adhesive
- Aluminium Edging Strip (6)
- Aluminium Outer Corner (4)
- Flat roof drainage duct, square



DIY flat roof Maaseik, plain B600xD300xH262cm
 Impregnated Pine, DIY - including attachment material
45.9005V Weatherboard profile planks, impregnated
45.9005VZ Weatherboard profile planks, black

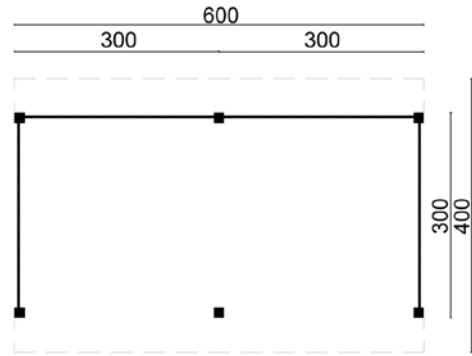

Optional extra's

- Easy-roofing (30m²) (6)
- EPDM (31m²) (31)
- Concrete pad footing with bevelled edges (charcoal) (6)
- Sinking prevention (6)
- Concrete pad footing with rounded edges (grey) (6)
- Concrete pad footing with rounded edges (charcoal) (6)

- Thermally galvanised height adjustment (6)
- Stainless steel height adjustment (6)
- EPDM Adhesive
- Aluminium Edging Strip (7)
- Aluminium Outer Corner (4)
- Flat roof drainage duct, square (2)



DIY flat roof Leuven, plain B690xD300xH262cm
 Impregnated Pine, including attachment material
 The windows and doors are of untreated spruce
45.9021V Weatherboard profile planks, impregnated
45.9021VZ Weatherboard profile planks, untreated

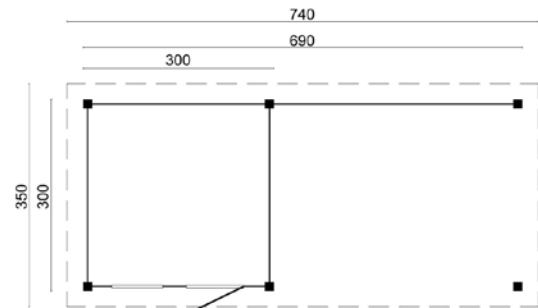

Optional extra's

- Easy-roofing (35m²) (7)
- EPDM (32m²) (32)
- Concrete pad footing with bevelled edges (charcoal) (6)
- Sinking prevention (6)
- Concrete pad footing with rounded edges (grey) (6)
- Concrete pad footing with rounded edges (charcoal) (6)
- Thermally galvanised height adjustment (6)
- Stainless steel height adjustment (6)

- EPDM Adhesive
- Glazing kit white
- Aluminium Edging Strip (8)
- Aluminium Outer Corner (4)
- Flat roof drainage duct, square (2)
- impregnation single door
- impregnation window



DIY wall modules.

Easy to integrate new wall modules, see page 403.
The types Bastenaken and Leuven pictured as example.





DIY open-sided barn Goor W600xD390xH312cm
 Unplaned larch/douglas, fresh sawn, core-free, not dried, top quality
 DIY - including attachment material
45.9001B Weatherboard profile planks, untreated
45.9001Z Weatherboard profile planks, black

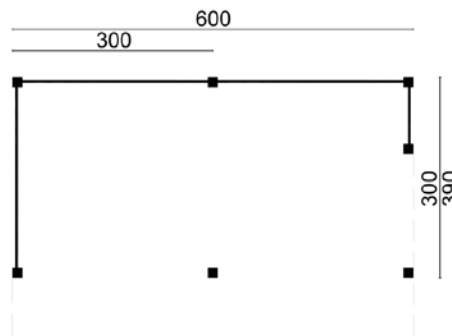

Optional extra's

- Roof shingles, straight (36m²) (12)
- Roof shingles, beavertail (36m²) (12)
- Roof shingles, hexagonal (36m²) (12)
- Roof tile profile boards (30m²) (30)
- Aquapan
- Gutter set plastic 65mm (charcoal)
- Gutter set plastic 100mm (charcoal)
- Gutter set thermally galvanised 125mm

- Concrete pad footing with bevelled edges (charcoal) (7)
- Sinking prevention (7)
- Concrete pad footing with rounded edges (grey) (7)
- Concrete pad footing with rounded edges (charcoal) (7)
- Thermally galvanised height adjustment (7)
- Stainless steel height adjustment (7)
- Roof covering kit (4)



DIY open-sided barn Markelo W600xD400xH312cm
 Unplaned larch/douglas, fresh sawn, core-free, not dried, top quality.
 DIY - including attachment material. The windows and doors are of untreated spruce.
45.9002B Weatherboard profile planks, untreated
45.9002Z Weatherboard profile planks, black

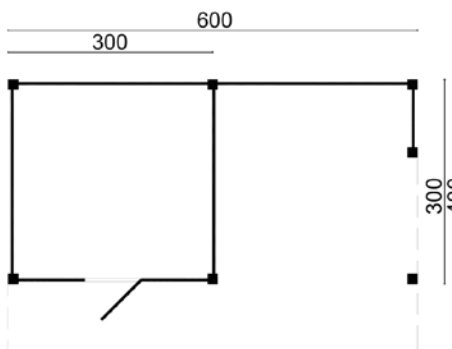

Optional extra's

- Roof shingles, straight (36m²) (12)
- Roof shingles, beavertail (36m²) (12)
- Roof shingles, hexagonal (36m²) (12)
- Roof tile profile boards (30m²) (30)
- Aquapan
- Gutter set plastic 65mm (charcoal)
- Gutter set plastic 100mm (charcoal)
- Gutter set thermally galvanised 125mm

- Concrete pad footing with bevelled edges (charcoal) (7)
- Sinking prevention (7)
- Concrete pad footing with rounded edges (grey) (7)
- Concrete pad footing with rounded edges (charcoal) (7)
- Thermally galvanised height adjustment (7)
- Stainless steel height adjustment (7)
- Roof covering kit (4)
- Larch/Douglas windows and doors (untreated)

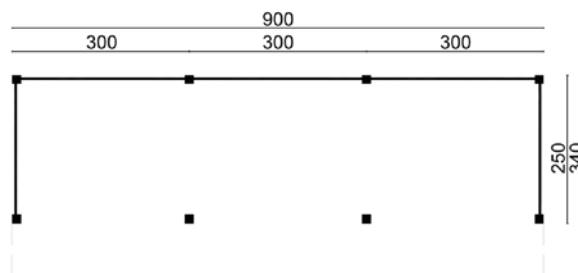

DIY open-sided barn Boekelo W900xD340xH312cm

Unplaned larch/douglas, fresh sawn, core-free, not dried, top quality
DIY - including attachment material

45.9003B Weatherboard profile planks, untreated

45.9003Z Weatherboard profile planks, black

Optional extra's

- Roof shingles, straight (48m²) (16)
- Roof shingles, beavertail (48m²) (16)
- Roof shingles, hexagonal (48m²) (16)
- Roof tile profile boards (42m²) (42)
- Aquapan
- Gutter set plastic 100mm (charcoal)
- Gutter set thermally galvanised 125mm

- Concrete pad footing with bevelled edges (charcoal) (8)
- Sinking prevention (8)
- Concrete pad footing with rounded edges (grey) (8)
- Concrete pad footing with rounded edges (charcoal) (8)
- Thermally galvanised height adjustment (8)
- Stainless steel height adjustment (8)
- Roof covering kit (5)

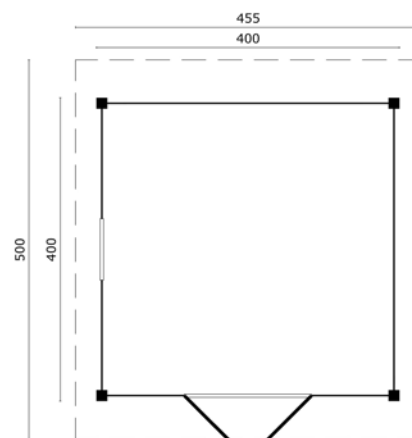

DIY apex roof Tubbergen W400xD400xH340cm

Planed larch/douglas, dried, core-free, top quality
DIY - including attachment material

45.9026B Weatherboard profile planks, untreated

45.9026Z Weatherboard profile planks, black

Optional extra's

- Roof shingles, straight (33m²) (11)
- Roof shingles, beavertail (33m²) (11)
- Roof shingles, hexagonal (33m²) (11)
- Roof tile profile boards (33m²) (33)
- Aquapan
- Gutter set plastic 65mm (charcoal)
- Gutter set plastic 100mm (charcoal)
- Gutter set thermally galvanised 125mm
- Concrete pad footing with bevelled edges (charcoal) (4)

- Sinking prevention (4)
- Concrete pad footing with rounded edges (grey) (4)
- Concrete pad footing with rounded edges (charcoal) (4)
- Thermally galvanised height adjustment (4)
- Stainless steel height adjustment (4)
- Roof covering kit (4)
- Glazing kit white
- Larch/Douglas windows and doors (untreated)



DIY flat roof Ommen W400xD300xH262cm
 Unplaned larch/douglas, fresh sawn, core-free, not dried, top quality
 DIY - including attachment material
45.9004B Weatherboard profile planks, untreated
45.9004Z Weatherboard profile planks, black

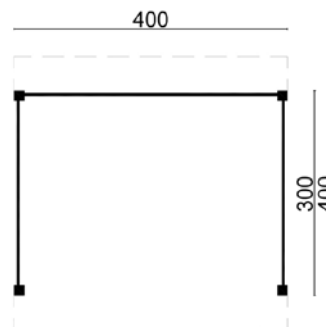

Optional extra's

- Easy-roofing (25m²) (5)
- EPDM (22m²) (22)
- Concrete pad footing with bevelled edges (charcoal) (4)
- Sinking prevention (4)
- Concrete pad footing with rounded edges (grey) (4)
- Concrete pad footing with rounded edges (charcoal) (4)

- Thermally galvanised height adjustment (4)
- Stainless steel height adjustment (4)
- EPDM Adhesive
- Aluminium Edging Strip (6)
- Aluminium Outer Corner (4)
- Flat roof drainage duct, square



DIY flat roof Dalfsen W600xD300xH262cm
 Unplaned larch/douglas, fresh sawn, core-free, not dried, top quality.
 DIY - including attachment material.
45.9005B Weatherboard profile planks, untreated
45.9005Z Weatherboard profile planks, black

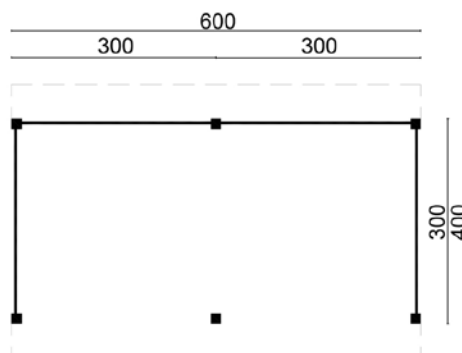

Optional extra's

- Easy-roofing (30m²) (6)
- EPDM (31m²) (31)
- Concrete pad footing with bevelled edges (charcoal) (6)
- Sinking prevention (6)
- Concrete pad footing with rounded edges (grey) (6)
- Concrete pad footing with rounded edges (charcoal) (6)

- Thermally galvanised height adjustment (6)
- Stainless steel height adjustment (6)
- EPDM Adhesive
- Aluminium Edging Strip (7)
- Aluminium Outer Corner (4)
- Flat roof drainage duct, square (2)



DIY flat roof Raalte W600xD410xH262cm

Unplaned larch/douglas, fresh sawn, core-free, not dried, top quality. DIY - including attachment material. The windows and doors are of untreated spruce.

45.9006B Weatherboard profile planks, untreated

45.9006Z Walls, black coated

Optional extra's

Easy-roofing (30m²) (6)

EPDM (37m²) (37)

Concrete pad footing with bevelled edges (charcoal) (6)

Sinking prevention (6)

Concrete pad footing with rounded edges (grey) (6)

Concrete pad footing with rounded edges (charcoal) (6)

Thermally galvanised height adjustment (6)

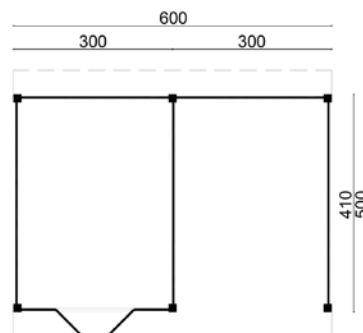

Stainless steel height adjustment (6)

EPDM Adhesive

Aluminium Edging Strip (9)

Aluminium Outer Corner (4)

Flat roof drainage duct, square (2)

Larch/Douglas doors (untreated)



DIY flat roof Nijverdaal W900xD410xH262cm

Unplaned larch/douglas, fresh sawn, core-free, not dried, top quality. DIY - including attachment material.

The windows and doors are of untreated spruce.

45.9007B Weatherboard profile planks, untreated

45.9007Z Weatherboard profile planks, black

Optional extra's

Easy-roofing (60m²) (12)

EPDM (54m²) (54)

Concrete pad footing with bevelled edges (charcoal) (8)

Sinking prevention (8)

Concrete pad footing with rounded edges (grey) (8)

Concrete pad footing with rounded edges (charcoal) (8)

Thermally galvanised height adjustment (8)

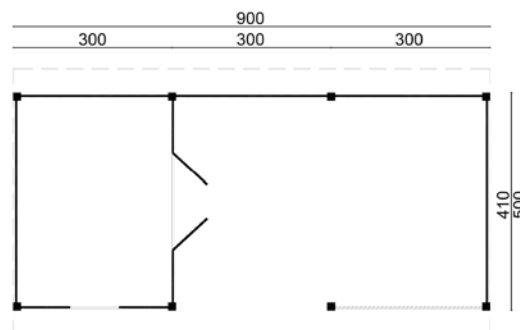

Stainless steel height adjustment (8)

EPDM Adhesive

Aluminium Edging Strip (8)

Aluminium Outer Corner (4)

Flat roof drainage duct, square (2)

Larch/Douglas windows and doors (untreated)

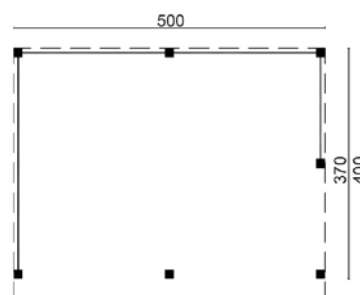

DIY flat roof Wezep W500xD370xH262cm

Planed larch/douglas, dried, core-free, top quality.
DIY - including attachment material.

45.9023B Weatherboard profile planks, untreated

45.9023Z Weatherboard profile planks, black

Optional extra's

- Easy-roofing (30m²) (6)
- EPDM (26m²) (26)
- Concrete pad footing with bevelled edges (charcoal) (7)
- Sinking prevention (7)
- Concrete pad footing with rounded edges (grey) (7)
- Concrete pad footing with rounded edges (charcoal) (7)

- Thermally galvanised height adjustment (7)
- Stainless steel height adjustment (7)
- EPDM Adhesive
- Aluminium Edging Strip (7)
- Aluminium Outer Corner (4)
- Flat roof drainage duct, square (2)

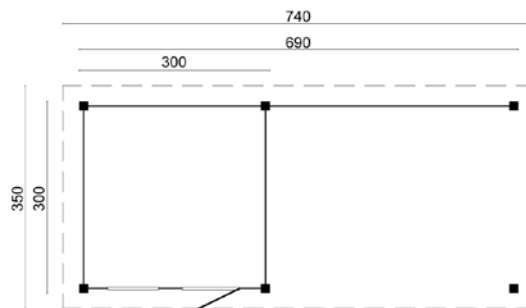

DIY flat roof Holten W690xD300xH262cm

Planed larch/douglas, dried, core-free, top quality.
The windows and doors are of untreated spruce.
DIY - including attachment material.

45.9021B Weatherboard profile planks, untreated

45.9021Z Weatherboard profile planks, black

Optional extra's

- Easy-roofing (35m²) (7)
- EPDM (32m²) (32)
- Concrete pad footing with bevelled edges (charcoal) (6)
- Sinking prevention (6)
- Concrete pad footing with rounded edges (grey) (6)
- Concrete pad footing with rounded edges (charcoal) (6)
- Thermally galvanised height adjustment (6)

- Stainless steel height adjustment (6)
- EPDM Adhesive
- Glazing kit white
- Aluminium Edging Strip (8)
- Aluminium Outer Corner (4)
- Flat roof drainage duct, square (2)
- Larch/Douglas windows and doors (untreated)



DIY flat roof Twello W743xD370xH262cm

Planed larch/douglas, dried, core-free, top quality.
The windows and doors are of untreated spruce.
DIY - including attachment material.

45.9024B Weatherboard profile planks, untreated

45.9024Z Weatherboard profile planks, black

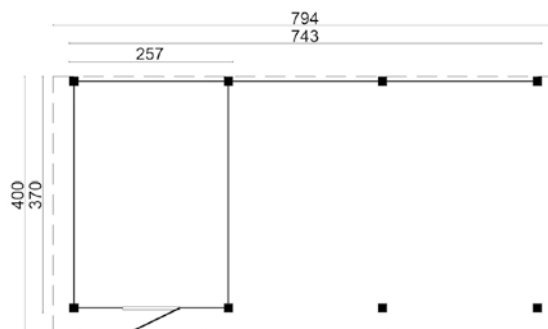

Optional extra's

- Easy-roofing (40m²) (8)
- EPDM (35m²) (35)
- Concrete pad footing with bevelled edges (charcoal) (8)
- Sinking prevention (8)
- Concrete pad footing with rounded edges (grey) (8)
- Concrete pad footing with rounded edges (charcoal) (8)
- Thermally galvanised height adjustment (8)
- Stainless steel height adjustment (8)
- EPDM Adhesive
- Glazing kit white
- Aluminium Edging Strip (9)
- Aluminium Outer Corner (4)
- Flat roof drainage duct, square (3)
- Larch/Douglas door (untreated)



40.0362

Egberdin - See-Through Cloth

W300xH244 cm

Complete set including rails, cloth, clasps, fitting kit and cloth anchoring screws.

Egberdin is a fine-meshed cloth that you can see through. It is 50% water retaining, 67% reflective and 50% windproof. It comes with aluminium profile and stainless steel couplings and can be rolled up when required.

An excellent solution for extending your time in the garden when it becomes cooler in the evenings or if the wind picks up.

Ideal for quickly sealing walls in arbours/roofs and verandas. You can shorten the width and height yourself.

**DIY wall modules.**

Easy to integrate new wall modules, see page 403.
The types Holten and Twello pictured as example.



Modular roofs, larch/douglas Bergen

Design your very own Roof, Garden House, Carport, Sauna, Garage, Open-Sided Barn and more with this unique modular system!

All components are delivered made to measure (with the exception of the fences en sloping walls).

You can extend your basic pack by using an extension set. This can be shortened if required.

You can create numerous variations by adding walls, doors and windows.

All modules are made from top quality dried, planed, and core-free larch/douglas wood and supplied including the necessary fitting kits along with a comprehensive construction manual.

To make it easier for you, we have put together some combinations from the Bergen.
If you can't find your favourite model amongst these, then it is also possible to design your own.

Step 1
Choose the basic model
(length 500cm)

Step 2
Choose the extension
set(s)
(length 240cm)

Step 3
Choose the wall set
(plus slat set)

Step 4
Choose the windows and
doors
(plus adjustment frame)

Step 5
Choose possible options
(foundation, concrete pad
footing, etc.)

For full pricing options, please contact your Authorised Tuindeco Dealer.

Bergen L (columns 12.0x12.0cm / girders 4.5x12.0cm / walk-through height 205cm)

42.7910		Bergen L basic package with 12.0x12.0cm posts	W470xD310cm
42.7911		Bergen L extension set with 12.0x12.0cm posts	W210xD310cm
42.7932	untreated	Bergen L lap board back wall module U	W198xH152cm
42.7933	black	Bergen L lap board back wall module U	W198xH152cm
42.7949		Bergen L slat set for wall module U	W198cm
42.7934	untreated	Bergen L lap board side/front wall module P	W198xH230cm
42.7935	black	Bergen L lap board side/front wall module P	W198xH230cm
42.7949		Bergen L slat set for wall module P	W198cm
42.7953		Adjustment frame for single door/single window	
42.7954		Adjustment frame for double door/double window	
42.8071		Glass partition type P B198xH230cm	

Bergen XL (columns 14.5x14.5cm / girders 4.5x14.5cm / walk-through height 229cm)

42.7915		Bergen XL basic package with 14.5x14.5cm posts	W680xD450cm
42.7916		Bergen XL extension set with 14.5x14.5cm posts	W312xD450cm
42.7936	untreated	Bergen XL lap board back wall module W	W298xH152cm
42.7937	black	Bergen XL lap board back wall module W	W298xH152cm
42.7950		Bergen XL slat set for wall module W	W298cm
42.7940	untreated	Bergen XL lap board side/front wall module S	W298xH269cm
42.7941	black	Bergen XL lap board side/front wall module S	W298xH269cm
42.7951		Bergen XL slat set for wall module S	W298cm
42.7953		Adjustment frame for single door/single window	
42.7954		Adjustment frame for double door/double window	
		Glass partition upon request	

Options for Bergen

45.8009	Planed larch/douglas post	14.5x14.5x300cm shipped
45.8029	Planed larch/douglas intermediate post	14.5x14.5x125cm with diamond head
9.40700	Larch/douglas fencing Perfect (see page 52)	H70xW280cm
35.7650	Larch/douglas cover for fencing Perfect	4.5x13.5x280cm

At the Bergen barns can be ordered as an option, see page 405-407

The prices mentioned on the following pages include untreated spruce windows and doors

You can change the windows and doors at a surcharge or lower price, see page 220, 401-403

All other options can be found from page 400

For glass walls and wall modules see pages 219



BARN BERGEN TYPE 1

Bergen L type 1 W468xD306xH281cm
 Planted larch/douglas, dried, top quality and core-free.
42.7910

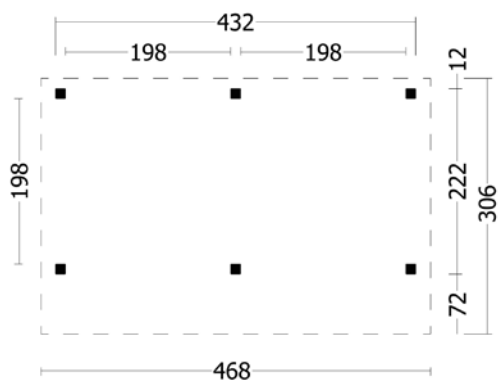

Optional extra's

- Roof shingles, straight (21m²) (7)
- Roof shingles, beavertail (21m²) (7)
- Roof shingles, hexagonal (21m²) (7)
- Roof tile profile boards (26m²) (26)
- Aquapan
- Gutter set plastic 100mm (charcoal)
- Gutter set thermally galvanised 125mm
- Concrete pad footing with bevelled edges (charcoal) (6)
- Sinking prevention (6)
- Concrete pad footing with rounded edges (grey) (6)
- Concrete pad footing with rounded edges (charcoal) (6)
- Thermally galvanised height adjustment (6)
- Stainless steel height adjustment (6)
- Roof covering kit (2)

Bergen XL type 1 W677xD452xH326cm
 Planted larch/douglas, dried, top quality and core-free.
42.7915

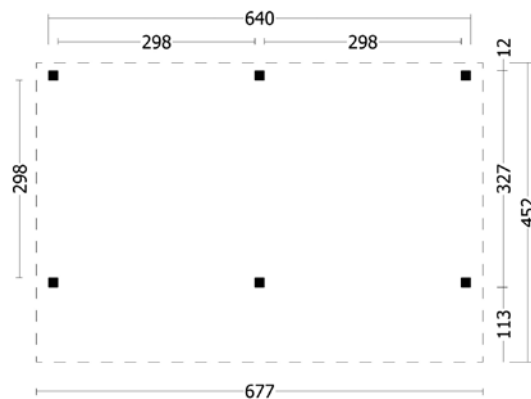

Optional extra's

- Roof shingles, straight (42m²) (14)
- Roof shingles, beavertail (42m²) (14)
- Roof shingles, hexagonal (42m²) (14)
- Roof tile profile boards (48m²) (48)
- Aquapan
- Gutter set plastic 100mm (charcoal)
- Gutter set thermally galvanised 125mm
- Concrete pad footing with bevelled edges (charcoal) (6)
- Sinking prevention (6)
- Concrete pad footing with rounded edges (grey) (6)
- Concrete pad footing with rounded edges (charcoal) (6)
- Thermally galvanised height adjustment (6)
- Stainless steel height adjustment (6)
- Roof covering kit (4)



BARN BERGEN TYPE 2

Bergen L type 2 W468xD306xH281cm
 Planed larch/douglas, dried, top quality and core-free.
42.7912 Weatherboard profile planks, untreated
42.7912ZW Weatherboard profile planks, black

Bergen XL type 2 W677xD452xH326cm
 Planed larch/douglas, dried, top quality and core-free.
42.7917 Weatherboard profile planks, untreated
42.7917ZW Weatherboard profile planks, black

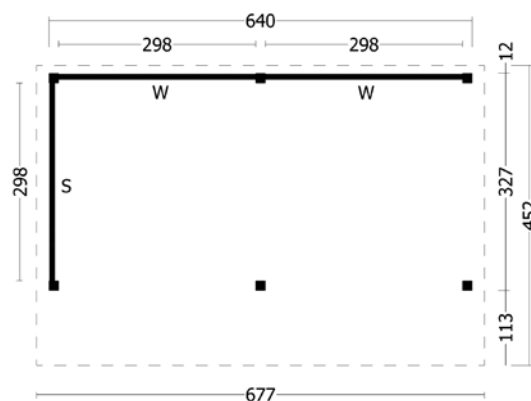
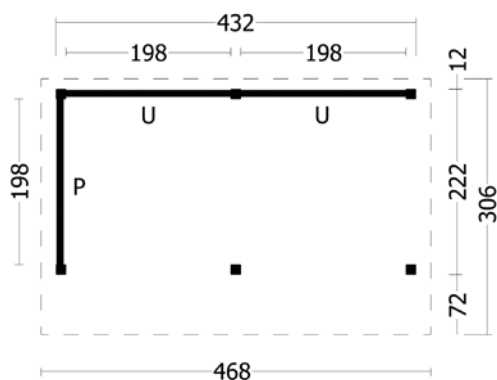

Optional extra's

- Roof shingles, straight (21m²) (7)
- Roof shingles, beavertail (21m²) (7)
- Roof shingles, hexagonal (21m²) (7)
- Roof tile profile boards (26m²) (26)
- Aquapan
- Gutter set plastic 100mm (charcoal)
- Gutter set thermally galvanised 125mm
- Concrete pad footing with bevelled edges (charcoal) (6)
- Sinking prevention (6)
- Concrete pad footing with rounded edges (grey) (6)
- Concrete pad footing with rounded edges (charcoal) (6)
- Thermally galvanised height adjustment (6)
- Stainless steel height adjustment (6)
- Roof covering kit (2)

Optional extra's

- Roof shingles, straight (42m²) (14)
- Roof shingles, beavertail (42m²) (14)
- Roof shingles, hexagonal (42m²) (14)
- Roof tile profile boards (48m²) (48)
- Aquapan
- Gutter set plastic 100mm (charcoal)
- Gutter set thermally galvanised 125mm
- Concrete pad footing with bevelled edges (charcoal) (6)
- Sinking prevention (6)
- Concrete pad footing with rounded edges (grey) (6)
- Concrete pad footing with rounded edges (charcoal) (6)
- Thermally galvanised height adjustment (6)
- Stainless steel height adjustment (6)
- Roof covering kit (4)



BARN BERGEN TYPE 3

Bergen L type 3 W468xD306xH281cm

Planed larch/douglas, dried, top quality and core-free. The windows and doors are of untreated spruce.

42.7913 Weatherboard profile planks, untreated

42.7913ZW Weatherboard profile planks, black

Bergen XL type 3 W677xD452xH326cm

Planed larch/douglas, dried, top quality and core-free. The windows and doors are of untreated spruce.

42.7918 Weatherboard profile planks, untreated

42.7918ZW Weatherboard profile planks, black

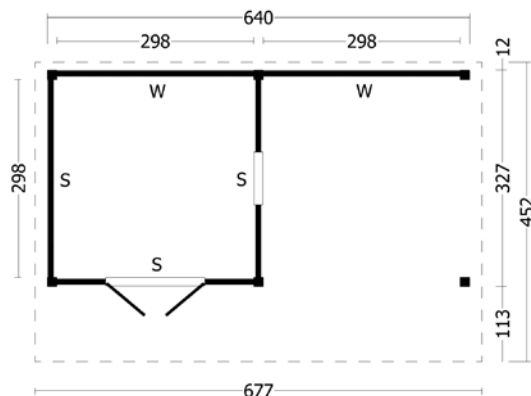
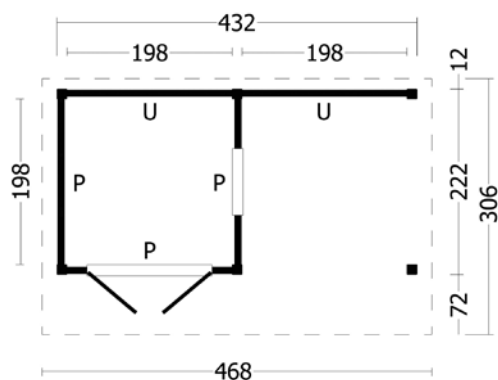

Optional extra's

- Roof shingles, straight (21m²) (7)
- Roof shingles, beavertail (21m²) (7)
- Roof shingles, hexagonal (21m²) (7)
- Roof tile profile boards (26m²) (26)
- Aquapan
- Gutter set plastic 100mm (charcoal)
- Gutter set thermally galvanised 125mm
- Concrete pad footing with bevelled edges (charcoal) (6)
- Sinking prevention (6)
- Concrete pad footing with rounded edges (grey) (6)
- Concrete pad footing with rounded edges (charcoal) (6)
- Thermally galvanised height adjustment (6)
- Stainless steel height adjustment (6)
- Roof covering kit (2)
- Glazing kit white
- Larch/Douglas windows and doors (untreated)

Optional extra's

- Roof shingles, straight (42m²) (14)
- Roof shingles, beavertail (42m²) (14)
- Roof shingles, hexagonal (42m²) (14)
- Roof tile profile boards (48m²) (48)
- Aquapan
- Gutter set plastic 100mm (charcoal)
- Gutter set thermally galvanised 125mm
- Concrete pad footing with bevelled edges (charcoal) (6)
- Sinking prevention (6)
- Concrete pad footing with rounded edges (grey) (6)
- Concrete pad footing with rounded edges (charcoal) (6)
- Thermally galvanised height adjustment (6)
- Stainless steel height adjustment (6)
- Roof covering kit (4)
- Glazing kit white
- Larch/Douglas windows and doors (untreated)



BARN BERGEN TYPE 4

Bergen L type 4 W468xD306xH281cm

Planed larch/douglas, dried, top quality and core-free. The windows and doors are of untreated spruce.

42.7914 Weatherboard profile planks, untreated

42.7914ZW Weatherboard profile planks, black

Bergen XL type 4 W677xD452xH326cm

Planed larch/douglas, dried, top quality and core-free. The windows and doors are of untreated spruce.

42.7919 Weatherboard profile planks, untreated

42.7919ZW Weatherboard profile planks, black

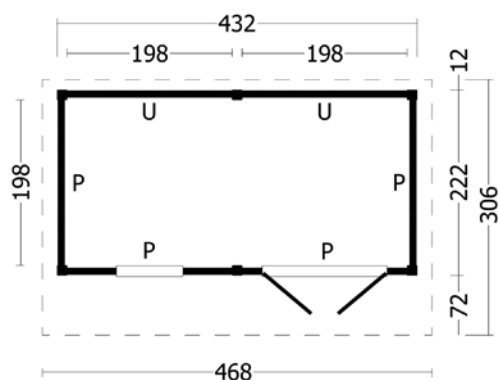

Optional extra's

- Roof shingles, straight (21m²) (7)
- Roof shingles, beavertail (21m²) (7)
- Roof shingles, hexagonal (21m²) (7)
- Roof tile profile boards (26m²) (26)
- Aquapan
- Gutter set plastic 100mm (charcoal)
- Gutter set thermally galvanised 125mm
- Concrete pad footing with bevelled edges (charcoal) (6)
- Sinking prevention (6)
- Concrete pad footing with rounded edges (grey) (6)
- Concrete pad footing with rounded edges (charcoal) (6)
- Thermally galvanised height adjustment (6)
- Stainless steel height adjustment (6)
- Roof covering kit (2)
- Glazing kit white
- Larch/Douglas windows and doors (untreated)

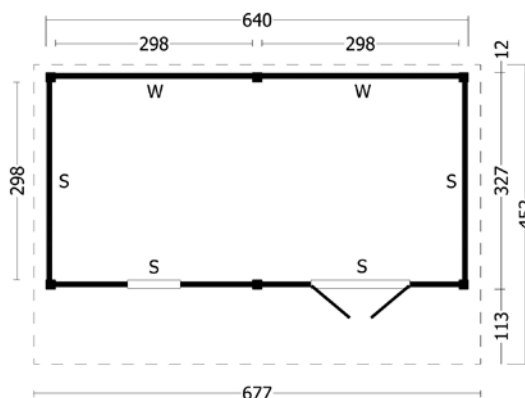

Optional extra's

- Roof shingles, straight (42m²) (14)
- Roof shingles, beavertail (42m²) (14)
- Roof shingles, hexagonal (42m²) (14)
- Roof tile profile boards (48m²) (48)
- Aquapan
- Gutter set plastic 100mm (charcoal)
- Gutter set thermally galvanised 125mm
- Concrete pad footing with bevelled edges (charcoal) (6)
- Sinking prevention (6)
- Concrete pad footing with rounded edges (grey) (6)
- Concrete pad footing with rounded edges (charcoal) (6)
- Thermally galvanised height adjustment (6)
- Stainless steel height adjustment (6)
- Roof covering kit (4)
- Glazing kit white
- Larch/Douglas windows and doors (untreated)



BARN BERGEN TYPE 5

Bergen L type 5 W678xD306xH281cm
 Planed larch/douglas, dried, top quality and core-free.
 42.7981

Bergen XL type 5 W989xD452xH326cm
 Planed larch/douglas, dried, top quality and core-free.
 42.7989

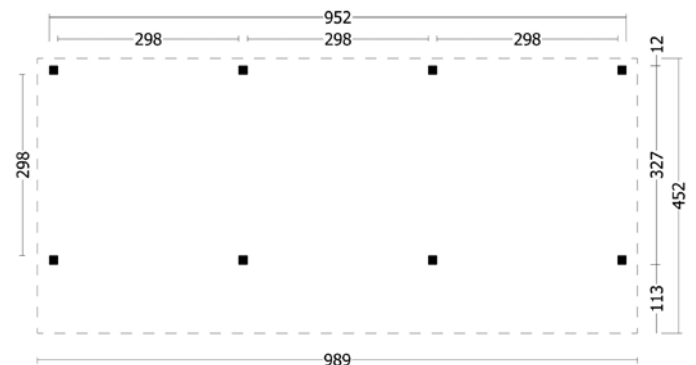
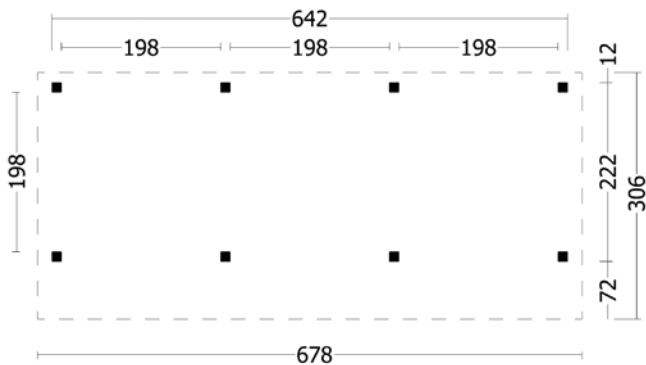

Optional extra's

- Roof shingles, straight (30m²) (10)
- Roof shingles, beavertail (30m²) (10)
- Roof shingles, hexagonal (30m²) (10)
- Roof tile profile boards (37m²) (37)
- Aquapan
- Gutter set plastic 100mm (charcoal)
- Gutter set thermally galvanised 125mm
- Concrete pad footing with bevelled edges (charcoal) (8)
- Sinking prevention (8)
- Concrete pad footing with rounded edges (grey) (8)
- Concrete pad footing with rounded edges (charcoal) (8)
- Thermally galvanised height adjustment (8)
- Stainless steel height adjustment (8)
- Roof covering kit (3)

Optional extra's

- Roof shingles, straight (57m²) (19)
- Roof shingles, beavertail (57m²) (19)
- Roof shingles, hexagonal (57m²) (19)
- Roof tile profile boards (62m²) (62)
- Aquapan
- Gutter set plastic 100mm (charcoal)
- Gutter set thermally galvanised 125mm
- Concrete pad footing with bevelled edges (charcoal) (8)
- Sinking prevention (8)
- Concrete pad footing with rounded edges (grey) (8)
- Concrete pad footing with rounded edges (charcoal) (8)
- Thermally galvanised height adjustment (8)
- Stainless steel height adjustment (8)
- Roof covering kit (6)



BARN BERGEN TYPE 6

Bergen L type 6 W678xD306xH281cm

Planed larch/douglas, dried, top quality and core-free.

42.7982 Weatherboard profile planks, untreated

42.7982ZW Weatherboard profile planks, black

Bergen XL type 6 W989xD452xH326cm

Planed larch/douglas, dried, top quality and core-free.

42.7990 Weatherboard profile planks, untreated

42.7990ZW Weatherboard profile planks, black

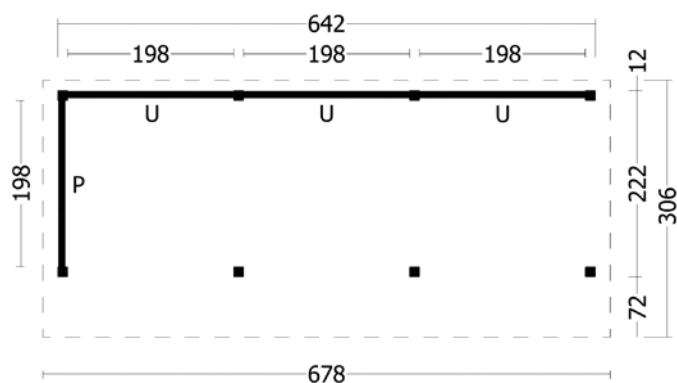

Optional extra's

- Roof shingles, straight (30m²) (10)
- Roof shingles, beavertail (30m²) (10)
- Roof shingles, hexagonal (30m²) (10)
- Roof tile profile boards (37m²) (37)
- Aquapan
- Gutter set plastic 100mm (charcoal)
- Gutter set thermally galvanised 125mm
- Concrete pad footing with bevelled edges (charcoal) (8)
- Sinking prevention (8)
- Concrete pad footing with rounded edges (grey) (8)
- Concrete pad footing with rounded edges (charcoal) (8)
- Thermally galvanised height adjustment (8)
- Stainless steel height adjustment (8)
- Roof covering kit (3)

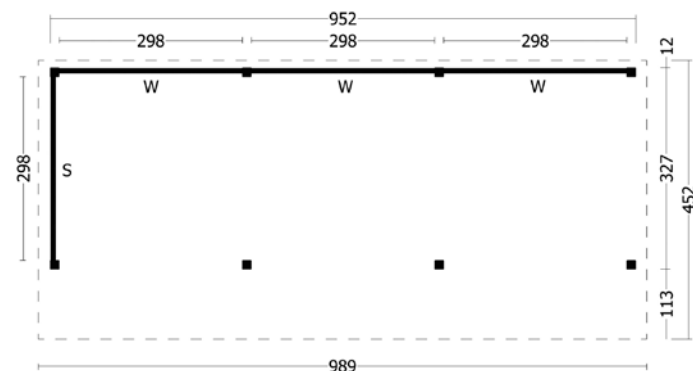

Optional extra's

- Roof shingles, straight (57m²) (19)
- Roof shingles, beavertail (57m²) (19)
- Roof shingles, hexagonal (57m²) (19)
- Roof tile profile boards (62m²) (62)
- Aquapan
- Gutter set plastic 100mm (charcoal)
- Gutter set thermally galvanised 125mm
- Concrete pad footing with bevelled edges (charcoal) (8)
- Sinking prevention (8)
- Concrete pad footing with rounded edges (grey) (8)
- Concrete pad footing with rounded edges (charcoal) (8)
- Thermally galvanised height adjustment (8)
- Stainless steel height adjustment (8)
- Roof covering kit (6)



BARN BERGEN TYPE 7

Bergen L type 7 W678xD306xH281cm

Planned larch/douglas, dried, top quality and core-free.

The windows and doors are of untreated spruce.

42.7983 Weatherboard profile planks, untreated

42.7983ZW Weatherboard profile planks, black

Bergen XL type 7 W989xD452xH326cm

Planned larch/douglas, dried, top quality and core-free.

The windows and doors are of untreated spruce.

42.7991 Weatherboard profile planks, untreated

42.7991ZW Weatherboard profile planks, black

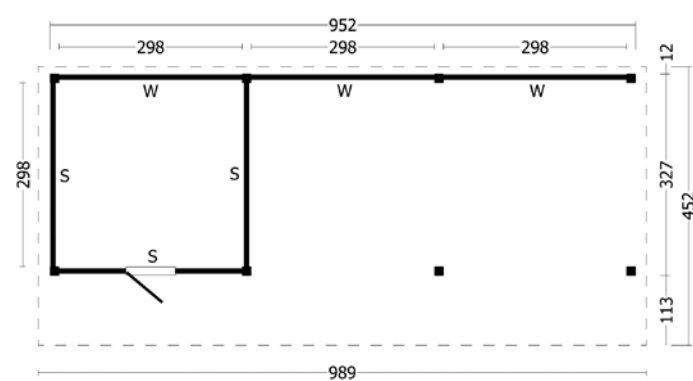
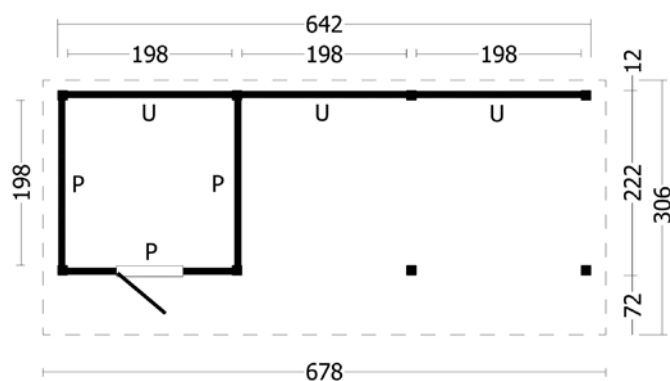

Optional extra's

- Roof shingles, straight (30m²) (10)
- Roof shingles, beavertail (30m²) (10)
- Roof shingles, hexagonal (30m²) (10)
- Roof tile profile boards (37m²) (37)
- Aquapan
- Gutter set plastic 100mm (charcoal)
- Gutter set thermally galvanised 125mm
- Concrete pad footing with bevelled edges (charcoal) (8)
- Sinking prevention (8)
- Concrete pad footing with rounded edges (grey) (8)
- Concrete pad footing with rounded edges (charcoal) (8)
- Thermally galvanised height adjustment (8)
- Stainless steel height adjustment (8)
- Roof covering kit (3)
- Larch/Douglas windows and doors (untreated)

Optional extra's

- Roof shingles, straight (57m²) (19)
- Roof shingles, beavertail (57m²) (19)
- Roof shingles, hexagonal (57m²) (19)
- Roof tile profile boards (62m²) (62)
- Aquapan
- Gutter set plastic 100mm (charcoal)
- Gutter set thermally galvanised 125mm
- Concrete pad footing with bevelled edges (charcoal) (8)
- Sinking prevention (8)
- Concrete pad footing with rounded edges (grey) (8)
- Concrete pad footing with rounded edges (charcoal) (8)
- Thermally galvanised height adjustment (8)
- Stainless steel height adjustment (8)
- Roof covering kit (6)
- Larch/Douglas windows and doors (untreated)



BARN BERGEN TYPE 8

Bergen L type 8 W678xD306xH281cm

Planed larch/douglas, dried, top quality and core-free.

The windows and doors are of untreated spruce.

42.7984 Weatherboard profile planks, untreated

42.7984ZW Weatherboard profile planks, black

Bergen XL type 8 W989xD452xH326cm

Planed larch/douglas, dried, top quality and core-free.

The windows and doors are of untreated spruce.

42.7992 Weatherboard profile planks, untreated

42.7992ZW Weatherboard profile planks, black

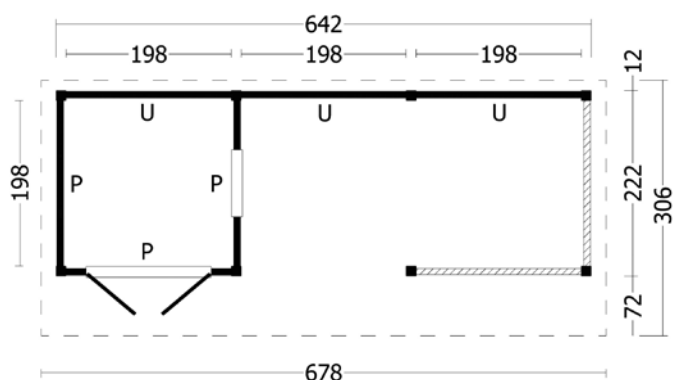

Optional extra's

- Roof shingles, straight (30m²) (10)
- Roof shingles, beavertail (30m²) (10)
- Roof shingles, hexagonal (30m²) (10)
- Roof tile profile boards (37m²) (37)
- Aquapan
- Gutter set plastic 100mm (charcoal)
- Gutter set thermally galvanised 125mm
- Concrete pad footing with bevelled edges (charcoal) (8)
- Sinking prevention (8)
- Concrete pad footing with rounded edges (grey) (8)
- Concrete pad footing with rounded edges (charcoal) (8)
- Thermally galvanised height adjustment (8)
- Stainless steel height adjustment (8)
- Roof covering kit (3)
- Glazing kit white
- Larch/Douglas windows and doors (untreated)

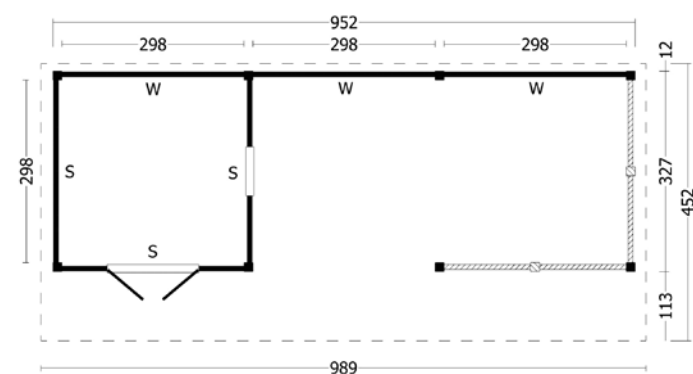

Optional extra's

- Roof shingles, straight (57m²) (19)
- Roof shingles, beavertail (57m²) (19)
- Roof shingles, hexagonal (57m²) (19)
- Roof tile profile boards (62m²) (62)
- Aquapan
- Gutter set plastic 100mm (charcoal)
- Gutter set thermally galvanised 125mm
- Concrete pad footing with bevelled edges (charcoal) (8)
- Sinking prevention (8)
- Concrete pad footing with rounded edges (grey) (8)
- Concrete pad footing with rounded edges (charcoal) (8)
- Thermally galvanised height adjustment (8)
- Stainless steel height adjustment (8)
- Roof covering kit (6)
- Glazing kit white
- Larch/Douglas windows and doors (untreated)



BARN BERGEN TYPE 9

Bergen L type 9 W888xD306xH281cm
 Planed larch/douglas, dried, top quality and core-free.
42.7985

Bergen XL type 9 W1302xD452xH326cm
 Planed larch/douglas, dried, top quality and core-free.
42.7993

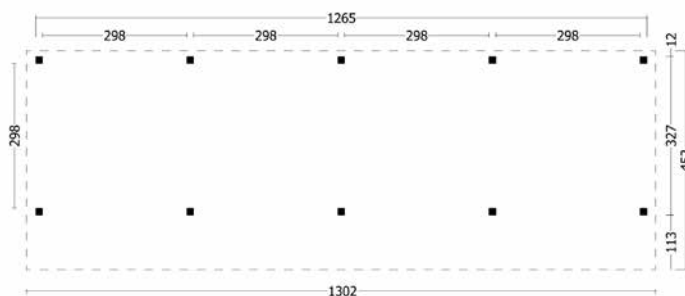
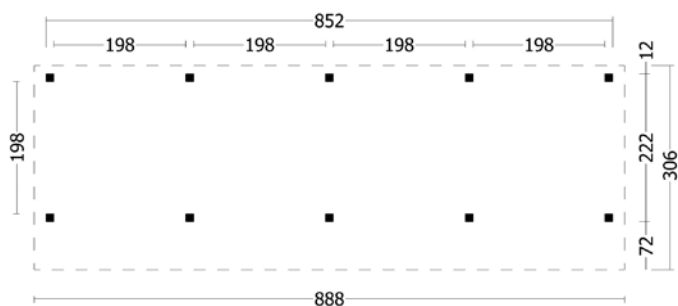

Optional extra's

- Roof shingles, straight (39m²) (13)
- Roof shingles, beavertail (39m²) (13)
- Roof shingles, hexagonal (39m²) (13)
- Roof tile profile boards (42m²) (42)
- Aquapan
- Gutter set plastic 100mm (charcoal)
- Gutter set thermally galvanised 125mm
- Concrete pad footing with bevelled edges (charcoal) (10)
- Sinking prevention (10)
- Concrete pad footing with rounded edges (grey) (10)
- Concrete pad footing with rounded edges (charcoal) (10)
- Thermally galvanised height adjustment (10)
- Stainless steel height adjustment (10)
- Roof covering kit (4)

Optional extra's

- Roof shingles, straight (75m²) (25)
- Roof shingles, beavertail (75m²) (25)
- Roof shingles, hexagonal (75m²) (25)
- Roof tile profile boards (82m²) (82)
- Aquapan
- Gutter set plastic 100mm (charcoal)
- Gutter set thermally galvanised 125mm
- Concrete pad footing with bevelled edges (charcoal) (10)
- Sinking prevention (10)
- Concrete pad footing with rounded edges (grey) (10)
- Concrete pad footing with rounded edges (charcoal) (10)
- Thermally galvanised height adjustment (10)
- Stainless steel height adjustment (10)
- Roof covering kit (8)



BARN BERGEN TYPE 10

Bergen L type 10 W888xD306xH281cm
 Planed larch/douglas, dried, top quality and core-free.
42.7686 Weatherboard profile planks, untreated
42.7986ZW Weatherboard profile planks, black

Bergen XL type 10 W1302xD452xH326cm
 Planed larch/douglas, dried, top quality and core-free.
42.7994 Weatherboard profile planks, untreated
42.7994ZW Weatherboard profile planks, black

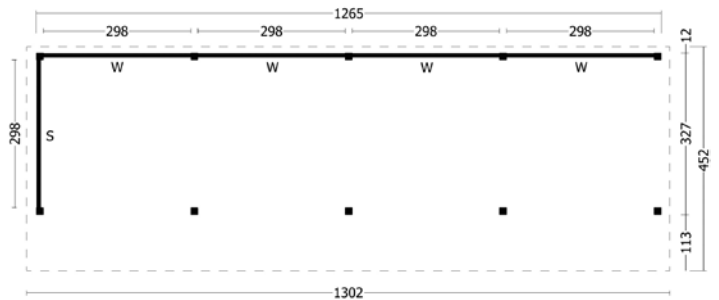
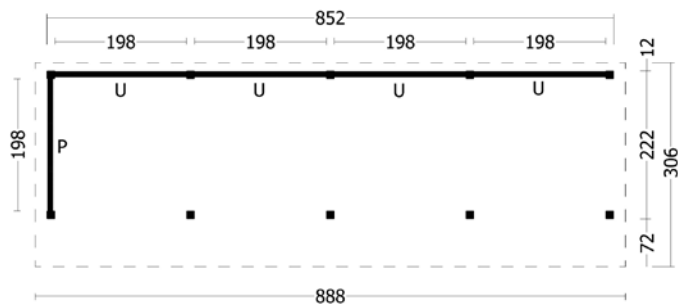

Optional extra's

- Roof shingles, straight (39m²) (13)
- Roof shingles, beavertail (39m²) (13)
- Roof shingles, hexagonal (39m²) (13)
- Roof tile profile boards (42m²) (42)
- Aquapan
- Gutter set plastic 100mm (charcoal)
- Gutter set thermally galvanised 125mm
- Concrete pad footing with bevelled edges (charcoal) (10)
- Sinking prevention (10)
- Concrete pad footing with rounded edges (grey) (10)
- Concrete pad footing with rounded edges (charcoal) (10)
- Thermally galvanised height adjustment (10)
- Stainless steel height adjustment (10)
- Roof covering kit (4)

Optional extra's

- Roof shingles, straight (75m²) (25)
- Roof shingles, beavertail (75m²) (25)
- Roof shingles, hexagonal (75m²) (25)
- Roof tile profile boards (82m²) (82)
- Aquapan
- Gutter set plastic 100mm (charcoal)
- Gutter set thermally galvanised 125mm
- Concrete pad footing with bevelled edges (charcoal) (10)
- Sinking prevention (10)
- Concrete pad footing with rounded edges (grey) (10)
- Concrete pad footing with rounded edges (charcoal) (10)
- Thermally galvanised height adjustment (10)
- Stainless steel height adjustment (10)
- Roof covering kit (8)



BARN BERGEN TYPE 11

Bergen L type 11 W888xD306xH281cm
 Planed larch/douglas, dried, top quality and core-free.
 The windows and doors are of untreated spruce.
42.7987 Weatherboard profile planks, untreated
42.7987ZW Weatherboard profile planks, black

Bergen XL type 11 W1302xD452xH326cm
 Planed larch/douglas, dried, top quality and core-free.
 The windows and doors are of untreated spruce.
42.7995 Weatherboard profile planks, untreated
42.7995ZW Weatherboard profile planks, black

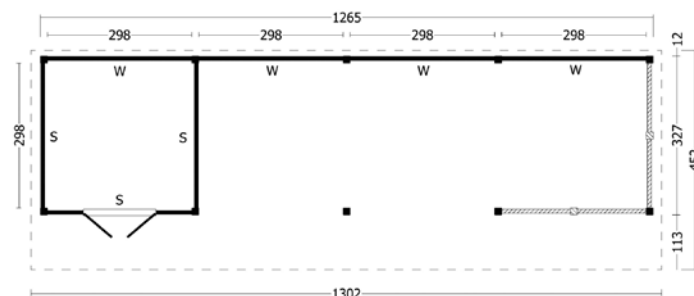
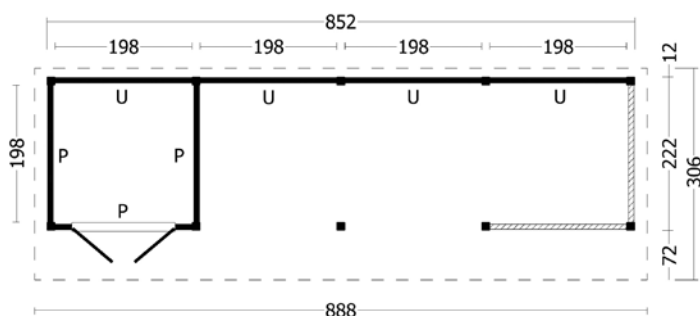

Optional extra's

- Roof shingles, straight (39m²) (13)
- Roof shingles, beavertail (39m²) (13)
- Roof shingles, hexagonal (39m²) (13)
- Roof tile profile boards (42m²) (42)
- Aquapan
- Gutter set plastic 100mm (charcoal)
- Gutter set thermally galvanised 125mm
- Concrete pad footing with bevelled edges (charcoal) (10)
- Sinking prevention (10)
- Concrete pad footing with rounded edges (grey) (10)
- Concrete pad footing with rounded edges (charcoal) (10)
- Thermally galvanised height adjustment (10)
- Stainless steel height adjustment (10)
- Roof covering kit (4)
- Glazing kit white
- Larch/Douglas windows and doors (untreated)

Optional extra's

- Roof shingles, straight (75m²) (25)
- Roof shingles, beavertail (75m²) (25)
- Roof shingles, hexagonal (75m²) (25)
- Roof tile profile boards (82m²) (82)
- Aquapan
- Gutter set plastic 100mm (charcoal)
- Gutter set thermally galvanised 125mm
- Concrete pad footing with bevelled edges (charcoal) (12)
- Sinking prevention (12)
- Concrete pad footing with rounded edges (grey) (12)
- Concrete pad footing with rounded edges (charcoal) (12)
- Thermally galvanised height adjustment (12)
- Stainless steel height adjustment (12)
- Roof covering kit (8)
- Glazing kit white
- Larch/Douglas windows and doors (untreated)



BARN BERGEN TYPE 12

Bergen L type 12 W888xD306xH281cm
 Planed larch/douglas, dried, top quality and core-free.
 The windows and doors are of untreated spruce.
42.7988 Weatherboard profile planks, untreated
42.7988ZW Weatherboard profile planks, black

Bergen XL type 12 W1302xD452xH326cm
 Planed larch/douglas, dried, top quality and core-free.
 The windows and doors are of untreated spruce.
42.7996 Weatherboard profile planks, untreated
42.7996ZW Weatherboard profile planks, black

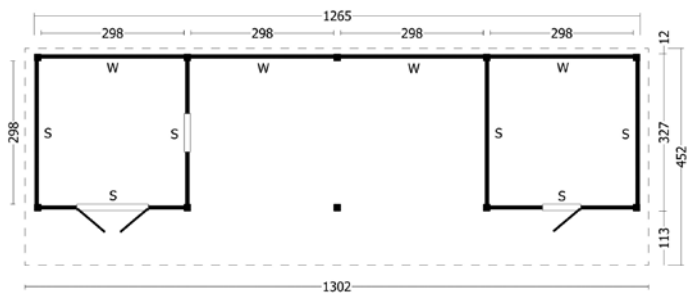
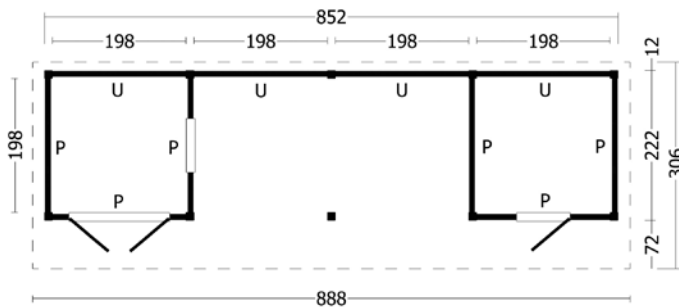

Optional extra's

- Roof shingles, straight (39m²) (13)
- Roof shingles, beavertail (39m²) (13)
- Roof shingles, hexagonal (39m²) (13)
- Roof tile profile boards (42m²) (42)
- Aquapan
- Gutter set plastic 100mm (charcoal)
- Gutter set thermally galvanised 125mm
- Concrete pad footing with bevelled edges (charcoal) (10)
- Sinking prevention (10)
- Concrete pad footing with rounded edges (grey) (10)
- Concrete pad footing with rounded edges (charcoal) (10)
- Thermally galvanised height adjustment (10)
- Stainless steel height adjustment (10)
- Roof covering kit (4)
- Glazing kit white
- Larch/Douglas windows and doors (untreated)

Optional extra's

- Roof shingles, straight (75m²) (25)
- Roof shingles, beavertail (75m²) (25)
- Roof shingles, hexagonal (75m²) (25)
- Roof tile profile boards (82m²) (82)
- Aquapan
- Gutter set plastic 100mm (charcoal)
- Gutter set thermally galvanised 125mm
- Concrete pad footing with bevelled edges (charcoal) (10)
- Sinking prevention (10)
- Concrete pad footing with rounded edges (grey) (10)
- Concrete pad footing with rounded edges (charcoal) (10)
- Thermally galvanised height adjustment (10)
- Stainless steel height adjustment (10)
- Roof covering kit (8)
- Glazing kit white
- Larch/Douglas windows and doors (untreated)

Modular roofs, larch/douglas Oslo

Design your very own Roof, Garden House, Carport, Sauna, Garage, Open-Sided Barn and more with this unique modular system!

All components are delivered made to measure (with the exception of the fences).

You can extend your basic pack by using an extension set. This can be shortened if required.

You can create numerous variations by adding walls, doors and windows.

All modules are made from top quality dried, planed, and core-free larch/douglas wood and supplied including the necessary fitting kits along with a comprehensive construction manual.

To make it easier for you, we have put together some combinations from the Bergen.
If you can't find your favourite model amongst these, then it is also possible to design your own.

Step 1
Choose the basic model
(length 500cm)

Step 2
Choose the extension
set(s)
(length 240cm)

Step 3
Choose the wall set
(plus slat set)

Step 4
Choose the windows and
doors
(plus adjustment frame)

Step 5
Choose possible options
(foundation, concrete pad
footing, etc.)

For full pricing options, please contact your Authorised Tuindeco Dealer.

Oslo L (columns 14.5x14.5cm / girders 4.5x14.5cm / walk-through height 230cm)

42.7900		Oslo L basic package (incl. EPDM and roof duct)	W480xD380xH272cm
42.7901		Oslo L extension set (incl. EPDM)	W212xD380xH272cm
42.7934	untreated	Oslo L lap board rear/front wall module P	W198xH230cm
42.7935	black	Oslo L lap board rear/front wall module P	W198xH230cm
42.7949		Oslo L slat set for wall module P	W198cm
42.7938	untreated	Oslo L lap board sidewall module R	W298xH230cm
42.7939	black	Oslo L lap board sidewall module R	W298xH230cm
42.7950		Oslo L slat set for wall module R	W298cm
42.7953		Adjustment frame for single door/single window	
42.7954		Adjustment frame for double door/double window	
42.8071		Glass partition type P B198xH230cm	
42.8072		Glass partition type R B298xH230cm	

Oslo XL (columns 14.5x14.5cm / girders 4.5x14.5cm / walk-through height 230cm)

42.7905		Oslo XL basic package (incl. EPDM and roof duct)	W680xD430xH272cm
42.7906		Oslo XL extension set (incl. EPDM)	W312xD430xH272cm
42.7938	untreated	Oslo XL lap board rear/front wall module R	W298xH230cm
42.7939	black	Oslo XL lap board rear/front wall module R	W298xH230cm
42.7950		Oslo XL slat set for wall module R	W298cm
42.7942	untreated	Oslo XL lap board sidewall module T	W348xH230cm
42.7943	black	Oslo XL lap board sidewall module T	W348xH230cm
42.7952		Oslo XL slat set for wall module T	W348cm
42.7930	untreated	Oslo XL Wall module G + half wall	W167x230cm
42.7931	black	Oslo XL Wall module G + half wall	W167x230cm
42.7948		Oslo XL slat set for wall module G	W167cm
42.7953		Adjustment frame for single door/single window	
42.7954		Adjustment frame for double door/double window	
42.8072		Glass partition type R B298xH230cm	
42.8073		Glass partition type T B348xH230cm	
42.8070		Glass partition type G B166.7xH230cm	

Options for Oslo

45.8009	Planed larch/douglas post	14.5x14.5x300cm shipped
45.8029	Planed larch/douglas post	14.5x14.5x125cm with diamond head
9.40700	Larch/douglas fencing Perfect (see page 52)	H70xW280cm
35.7650	Larch/douglas cover for fencing Perfect	4.5x13.5x280cm

All Oslo basic packages and expansion kits are standard including EPDM roofing

The prices mentioned on the following pages include untreated spruce windows and doors

You can change the windows and doors at a surcharge or lower price, see page 220, 401-403

For partition walls, you will need to order an extra roof beam once (45.8002)

All other options can be found from page 400

For glass walls and wall modules see pages 219



OSLO - FLAT ROOF TYPE 1

Oslo L type 1 W478xD380xH272cm
 Planed larch/douglas, dried, top quality and core-free.
42.7900

Oslo XL type 1 W678xD430xH272cm
 Planed larch/douglas, dried, top quality and core-free.
42.7905

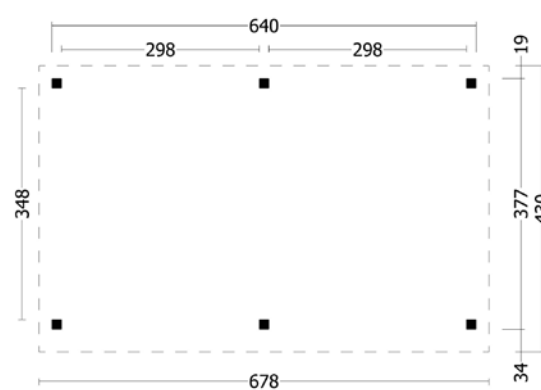
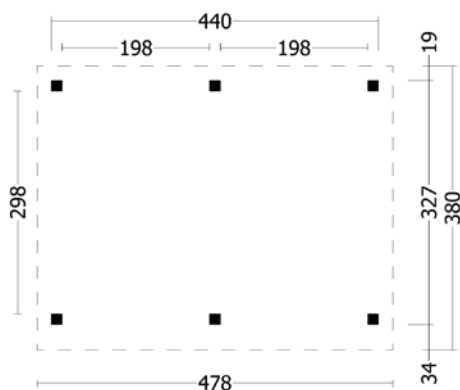

Optional extra's

- EPDM (included)
- Concrete pad footing with bevelled edges (charcoal) (6)
- Sinking prevention (6)
- Concrete pad footing with rounded edges (grey) (6)
- Concrete pad footing with rounded edges (charcoal) (6)
- Thermally galvanised height adjustment (6)
- Stainless steel height adjustment (6)
- Aluminium Edging Strip (6)
- Aluminium Outer Corner (4)
- Roof Duct, Round (included)

Optional extra's

- EPDM (included)
- Concrete pad footing with bevelled edges (charcoal) (6)
- Sinking prevention (6)
- Concrete pad footing with rounded edges (grey) (6)
- Concrete pad footing with rounded edges (charcoal) (6)
- Thermally galvanised height adjustment (6)
- Stainless steel height adjustment (6)
- Aluminium Edging Strip (8)
- Aluminium Outer Corner (4)
- Roof Duct, Round (included)



OSLO - FLAT ROOF TYPE 2

Oslo L type 2 W478xD380xH272cm

Planed larch/douglas, dried, top quality and core-free.

42.7902 Weatherboard profile planks, untreated

42.7902ZW Weatherboard profile planks, black

Oslo XL type 2 W678xD430xH272cm

Planed larch/douglas, dried, top quality and core-free.

42.7907 Weatherboard profile planks, untreated

42.7907ZW Weatherboard profile planks, black

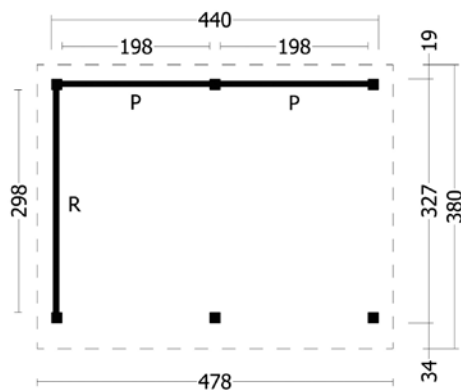

Optional extra's

- EPDM (included)
- Concrete pad footing with bevelled edges (charcoal) (6)
- Sinking prevention (6)
- Concrete pad footing with rounded edges (grey) (6)
- Concrete pad footing with rounded edges (charcoal) (6)
- Thermally galvanised height adjustment (6)
- Stainless steel height adjustment (6)
- Aluminium Edging Strip (6)
- Aluminium Outer Corner (4)
- Roof Duct, Round (included)

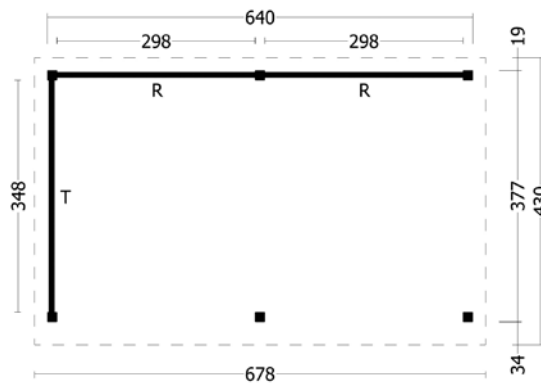

Optional extra's

- EPDM (included)
- Concrete pad footing with bevelled edges (charcoal) (6)
- Sinking prevention (6)
- Concrete pad footing with rounded edges (grey) (6)
- Concrete pad footing with rounded edges (charcoal) (6)
- Thermally galvanised height adjustment (6)
- Stainless steel height adjustment (6)
- Aluminium Edging Strip (8)
- Aluminium Outer Corner (4)
- Roof Duct, Round (included)



OSLO - FLAT ROOF TYPE 3

Oslo L type 3 W478xD380xH272cm
 Planed larch/douglas, dried, top quality and core-free.
42.7903 Weatherboard profile planks, untreated
42.7903ZW Weatherboard profile planks, black

Oslo XL type 3 W678xD430xH272cm
 Planed larch/douglas, dried, top quality and core-free.
42.7908 Weatherboard profile planks, untreated
42.7908ZW Weatherboard profile planks, black

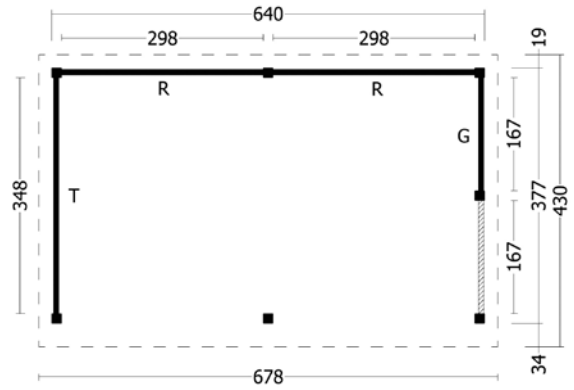
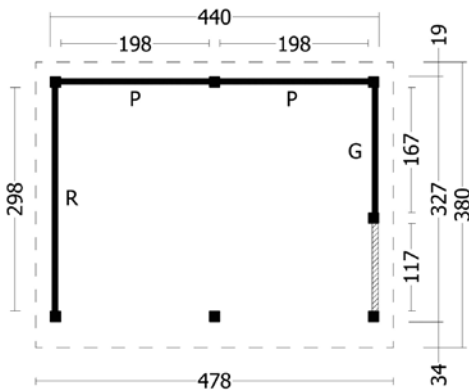

- Optional extra's**
 EPDM (included)
 Concrete pad footing with bevelled edges (charcoal) (7)
 Sinking prevention (7)
 Concrete pad footing with rounded edges (grey) (7)
 Concrete pad footing with rounded edges (charcoal) (7)
 Thermally galvanised height adjustment (7)
 Stainless steel height adjustment (7)
 Aluminium Edging Strip (6)
 Aluminium Outer Corner (4)
 Roof Duct, Round (included)

- Optional extra's**
 EPDM (included)
 Concrete pad footing with bevelled edges (charcoal) (7)
 Sinking prevention (7)
 Concrete pad footing with rounded edges (grey) (7)
 Concrete pad footing with rounded edges (charcoal) (7)
 Thermally galvanised height adjustment (7)
 Stainless steel height adjustment (7)
 Aluminium Edging Strip (8)
 Aluminium Outer Corner (4)
 Roof Duct, Round (included)



OSLO - FLAT ROOF TYPE 4

Oslo L type 4 W478xD380xH272cm
 Planed larch/douglas, dried, top quality and core-free. The windows and doors are of untreated spruce.
42.7904 Weatherboard profile planks, untreated
42.7904ZW Weatherboard profile planks, black

Oslo XL type 4 W678xD430xH272cm
 Planed larch/douglas, dried, top quality and core-free. The windows and doors are of untreated spruce.
42.7909 Weatherboard profile planks, untreated
42.7909ZW Weatherboard profile planks, black

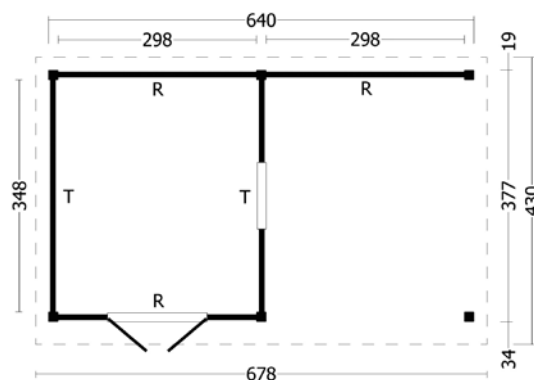
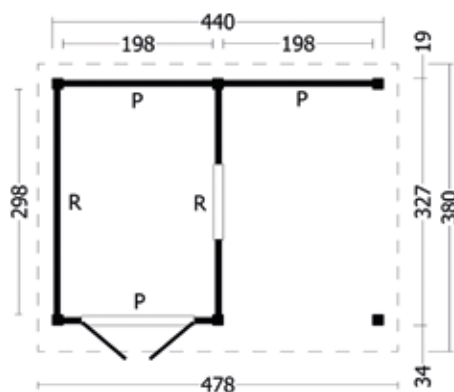

- Optional extra's**
 EPDM (included)
 Concrete pad footing with bevelled edges (charcoal) (6)
 Sinking prevention (6)
 Concrete pad footing with rounded edges (grey) (6)
 Concrete pad footing with rounded edges (charcoal) (6)
 Thermally galvanised height adjustment (6)
 Stainless steel height adjustment (6)
 Glazing kit white
 Aluminium Edging Strip (6)
 Aluminium Outer Corner (4)
 Roof Duct, Round (included)
 Larch/Douglas windows and doors (untreated)

- Optional extra's**
 EPDM (included)
 Concrete pad footing with bevelled edges (charcoal) (6)
 Sinking prevention (6)
 Concrete pad footing with rounded edges (grey) (6)
 Concrete pad footing with rounded edges (charcoal) (6)
 Thermally galvanised height adjustment (6)
 Stainless steel height adjustment (6)
 Glazing kit white
 Aluminium Edging Strip (8)
 Aluminium Outer Corner (4)
 Roof Duct, Round (included)
 Larch/Douglas windows and doors (untreated)



OSLO - FLAT ROOF TYPE 5

Oslo L type 5 W690xD380xH272cm
 Planed larch/douglas, dried, top quality and core-free.
 42.7965

Oslo XL type 5 W990xD430xH272cm
 Planed larch/douglas, dried, top quality and core-free.
 42.7973

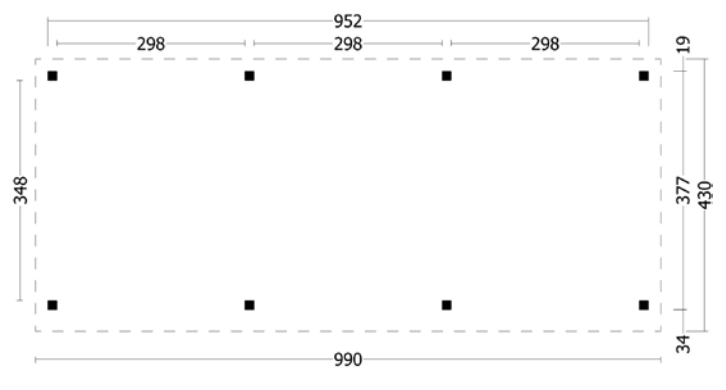
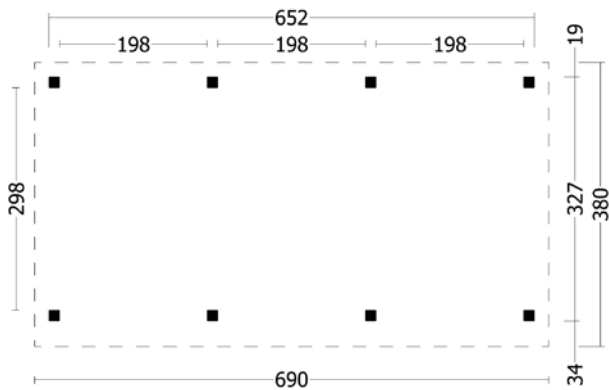

- Optional extra's**
- EPDM (included)
 - Concrete pad footing with bevelled edges (charcoal) (8)
 - Sinking prevention (8)
 - Concrete pad footing with rounded edges (grey) (8)
 - Concrete pad footing with rounded edges (charcoal) (8)
 - Thermally galvanised height adjustment (8)
 - Stainless steel height adjustment (8)
 - Aluminium Edging Strip (8)
 - Aluminium Outer Corner (4)
 - Roof Duct, Round (included)

- Optional extra's**
- EPDM (included)
 - Concrete pad footing with bevelled edges (charcoal) (8)
 - Sinking prevention (8)
 - Concrete pad footing with rounded edges (grey) (8)
 - Concrete pad footing with rounded edges (charcoal) (8)
 - Thermally galvanised height adjustment (8)
 - Stainless steel height adjustment (8)
 - Aluminium Edging Strip (10)
 - Aluminium Outer Corner (4)
 - Roof Duct, Round (included)



OSLO - FLAT ROOF TYPE 6

Oslo L type 6 W690xD380xH272cm

Planed larch/douglas, dried, top quality and core-free.

42.7966 Weatherboard profile planks, untreated

42.7966ZW Weatherboard profile planks, black

Oslo XL type 6 W990xD430xH272cm

Planed larch/douglas, dried, top quality and core-free.

42.7974 Weatherboard profile planks, untreated

42.7974ZW Weatherboard profile planks, black

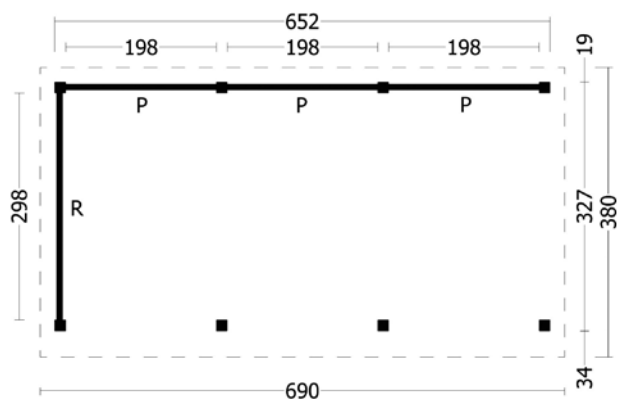

Optional extra's

- EPDM (included)
- Concrete pad footing with bevelled edges (charcoal) (8)
- Sinking prevention (8)
- Concrete pad footing with rounded edges (grey) (8)
- Concrete pad footing with rounded edges (charcoal) (8)
- Thermally galvanised height adjustment (8)
- Stainless steel height adjustment (8)
- Aluminium Edging Strip (8)
- Aluminium Outer Corner (4)
- Roof Duct, Round (included)

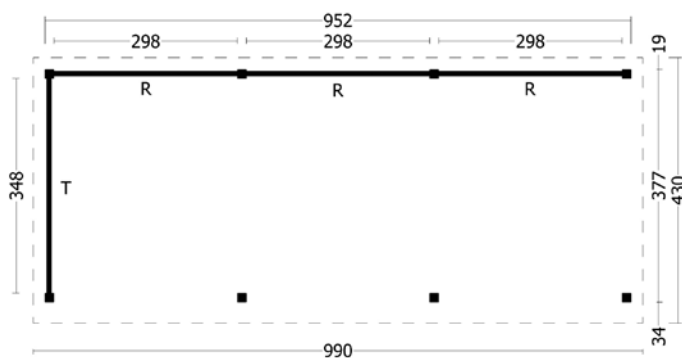

Optional extra's

- EPDM (included)
- Concrete pad footing with bevelled edges (charcoal) (8)
- Sinking prevention (8)
- Concrete pad footing with rounded edges (grey) (8)
- Concrete pad footing with rounded edges (charcoal) (8)
- Thermally galvanised height adjustment (8)
- Stainless steel height adjustment (8)
- Aluminium Edging Strip (10)
- Aluminium Outer Corner (4)
- Roof Duct, Round (included)



OSLO - FLAT ROOF TYPE 7

Oslo L type 7 W690xD380xH272cm

Planed larch/douglas, dried, top quality and core-free. The windows and doors are of untreated spruce.

42.7967 Weatherboard profile planks, untreated

42.7967ZW Weatherboard profile planks, black

Oslo XL type 7 W990xD430xH272cm

Planed larch/douglas, dried, top quality and core-free. The windows and doors are of untreated spruce.

42.7975 Weatherboard profile planks, untreated

42.7975ZW Weatherboard profile planks, black

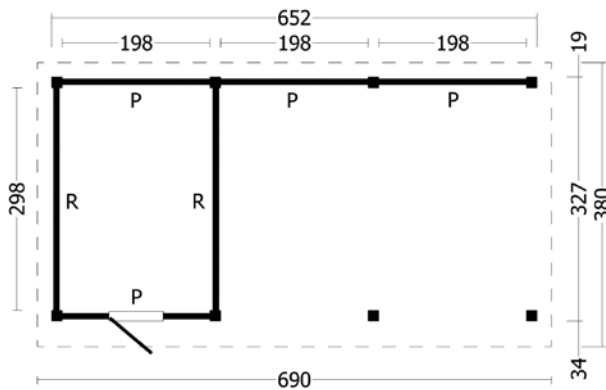

Optional extra's

- EPDM (included)
- Concrete pad footing with bevelled edges (charcoal) (8)
- Sinking prevention (8)
- Concrete pad footing with rounded edges (grey) (8)
- Concrete pad footing with rounded edges (charcoal) (8)
- Thermally galvanised height adjustment (8)
- Stainless steel height adjustment (8)
- Aluminium Edging Strip (8)
- Aluminium Outer Corner (4)
- Roof Duct, Round (included)
- Larch/Douglas windows and doors (untreated)

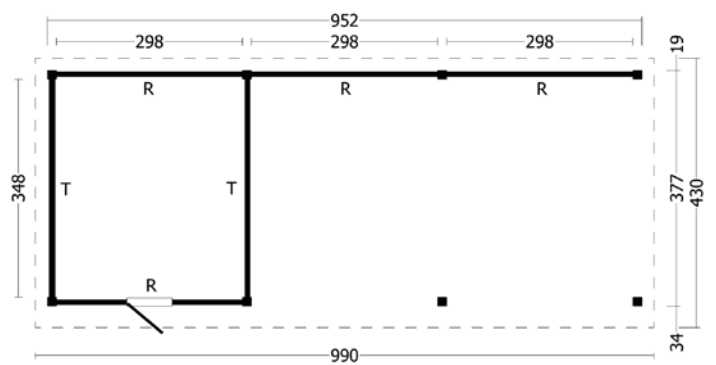

Optional extra's

- EPDM (included)
- Concrete pad footing with bevelled edges (charcoal) (8)
- Sinking prevention (8)
- Concrete pad footing with rounded edges (grey) (8)
- Concrete pad footing with rounded edges (charcoal) (8)
- Thermally galvanised height adjustment (8)
- Stainless steel height adjustment (8)
- Aluminium Edging Strip (10)
- Aluminium Outer Corner (4)
- Roof Duct, Round (included)
- Larch/Douglas windows and doors (untreated)



OSLO - FLAT ROOF TYPE 8

Oslo L type 8 W690xD380xH272cm
 Planed larch/douglas, dried, top quality and core-free. The windows and doors are of untreated spruce.
42.7968 Weatherboard profile planks, untreated
42.7968ZW Weatherboard profile planks, black

Oslo XL type 8 W990xD430xH272cm
 Planed larch/douglas, dried, top quality and core-free. The windows and doors are of untreated spruce.
42.7976 Weatherboard profile planks, untreated
42.7976ZW Weatherboard profile planks, black

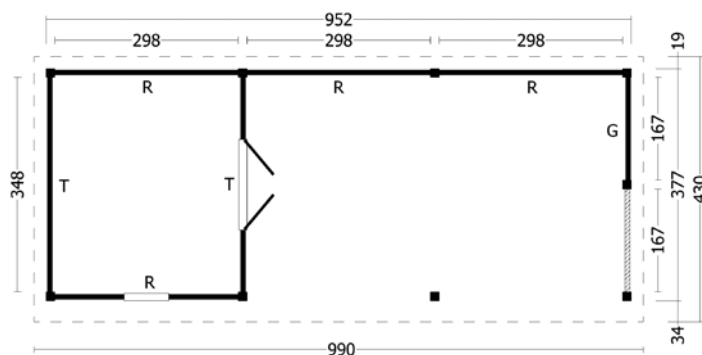
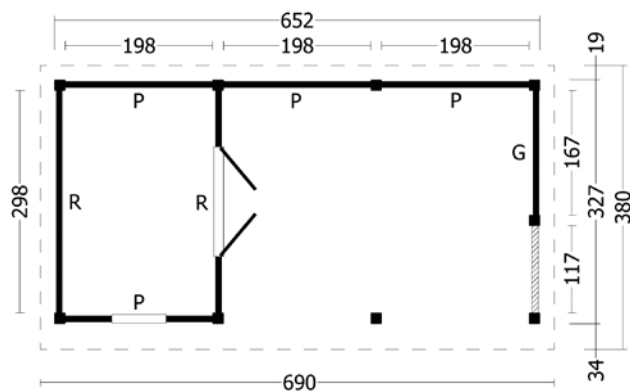

Optional extra's

- EPDM (included)
- Concrete pad footing with bevelled edges (charcoal) (9)
- Sinking prevention (9)
- Concrete pad footing with rounded edges (grey) (9)
- Concrete pad footing with rounded edges (charcoal) (9)
- Thermally galvanised height adjustment (9)
- Stainless steel height adjustment (9)
- Glazing kit white
- Aluminium Edging Strip (8)
- Aluminium Outer Corner (4)
- Roof Duct, Round (included)
- Larch/Douglas windows and doors (untreated)

Optional extra's

- EPDM (included)
- Concrete pad footing with bevelled edges (charcoal) (9)
- Sinking prevention (9)
- Concrete pad footing with rounded edges (grey) (9)
- Concrete pad footing with rounded edges (charcoal) (9)
- Thermally galvanised height adjustment (9)
- Stainless steel height adjustment (9)
- Glazing kit white
- Aluminium Edging Strip (10)
- Aluminium Outer Corner (4)
- Roof Duct, Round (included)
- Larch/Douglas windows and doors (untreated)



OSLO - FLAT ROOF TYPE 9

Oslo L type 9 W903xD380xH272cm
 Planed larch/douglas, dried, top quality and core-free.
 42.7969

Oslo XL type 9 W1303xD430xH272cm
 Planed larch/douglas, dried, top quality and core-free.
 42.7977

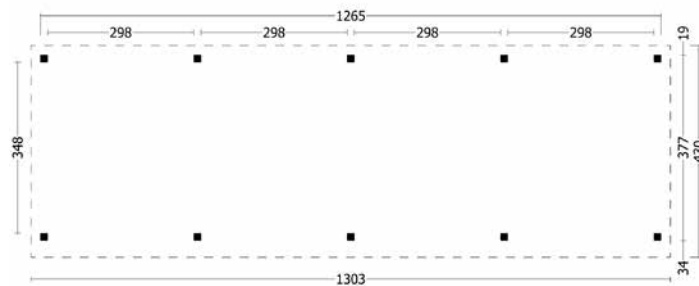
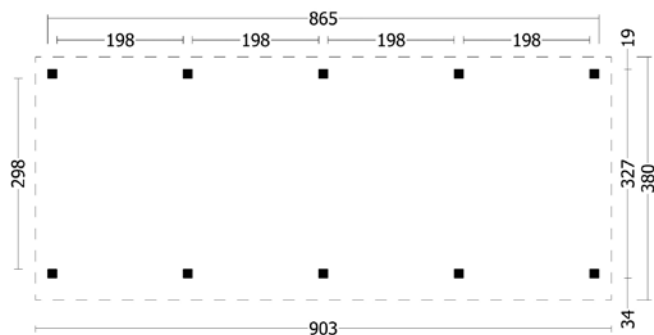

Optional extra's

- EPDM (included)
- Concrete pad footing with bevelled edges (charcoal) (10)
- Sinking prevention (10)
- Concrete pad footing with rounded edges (grey) (10)
- Concrete pad footing with rounded edges (charcoal) (10)
- Thermally galvanised height adjustment (10)
- Stainless steel height adjustment (10)
- Aluminium Edging Strip (9)
- Aluminium Outer Corner (4)
- Roof Duct, Round (included)

Optional extra's

- EPDM (included)
- Concrete pad footing with bevelled edges (charcoal) (10)
- Sinking prevention (10)
- Concrete pad footing with rounded edges (grey) (10)
- Concrete pad footing with rounded edges (charcoal) (10)
- Thermally galvanised height adjustment (10)
- Stainless steel height adjustment (10)
- Aluminium Edging Strip (13)
- Aluminium Outer Corner (4)
- Roof Duct, Round (included)



OSLO - FLAT ROOF TYPE 10

Oslo L type 10 W903xD380xH272cm
 Planed larch/douglas, dried, top quality and core-free. The windows and doors are of untreated spruce.
42.7970 Weatherboard profile planks, untreated
42.7970ZW Weatherboard profile planks, black

Oslo XL type 10 W1303xD430xH272cm
 Planed larch/douglas, dried, top quality and core-free. The windows and doors are of untreated spruce.
42.7978 Weatherboard profile planks, untreated
42.7978ZW Weatherboard profile planks, black

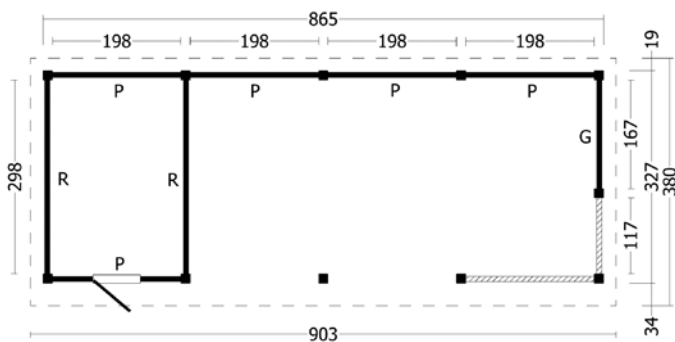

Optional extra's

- EPDM (included)
- Concrete pad footing with bevelled edges (charcoal) (11)
- Sinking prevention (11)
- Concrete pad footing with rounded edges (grey) (11)
- Concrete pad footing with rounded edges (charcoal) (11)
- Thermally galvanised height adjustment (11)
- Stainless steel height adjustment (11)
- Aluminium Edging Strip (9)
- Aluminium Outer Corner (4)
- Roof Duct, Round (included)
- Larch/Douglas windows and doors (untreated)

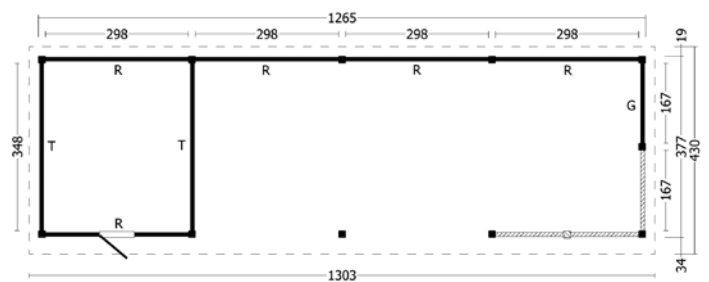

Optional extra's

- EPDM (included)
- Concrete pad footing with bevelled edges (charcoal) (12)
- Sinking prevention (12)
- Concrete pad footing with rounded edges (grey) (12)
- Concrete pad footing with rounded edges (charcoal) (12)
- Thermally galvanised height adjustment (12)
- Stainless steel height adjustment (12)
- Aluminium Edging Strip (13)
- Aluminium Outer Corner (4)
- Roof Duct, Round (included)
- Larch/Douglas windows and doors (untreated)



OSLO - FLAT ROOF TYPE 11

Oslo L type 11 W903xD380xH272cm
 Planed larch/douglas, dried, top quality and core-free. The windows and doors are of untreated spruce.
42.7971 Weatherboard profile planks, untreated
42.7971ZW Weatherboard profile planks, black

Oslo XL type 11 W1303xD430xH272cm
 Planed larch/douglas, dried, top quality and core-free. The windows and doors are of untreated spruce.
42.7979 Weatherboard profile planks, untreated
42.7979ZW Weatherboard profile planks, black

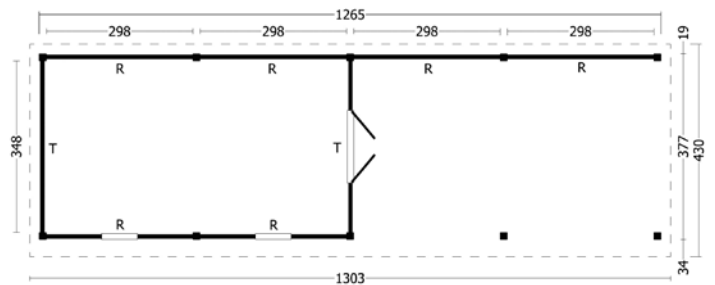
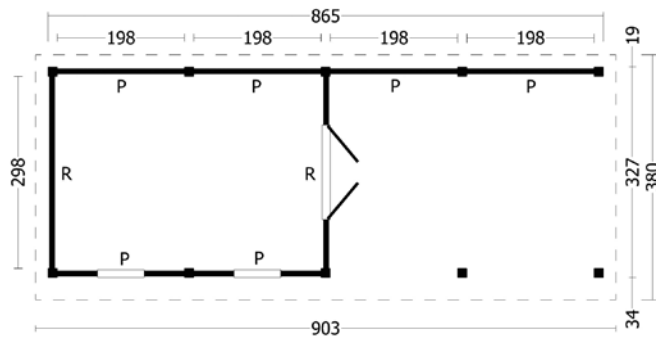

Optional extra's

- EPDM (included)
- Concrete pad footing with bevelled edges (charcoal) (10)
- Sinking prevention (10)
- Concrete pad footing with rounded edges (grey) (10)
- Concrete pad footing with rounded edges (charcoal) (10)
- Thermally galvanised height adjustment (10)
- Stainless steel height adjustment (10)
- Glazing kit white
- Aluminium Edging Strip (9)
- Aluminium Outer Corner (4)
- Roof Duct, Round (included)
- Larch/Douglas windows and doors (untreated)

Optional extra's

- EPDM (included)
- Concrete pad footing with bevelled edges (charcoal) (10)
- Sinking prevention (10)
- Concrete pad footing with rounded edges (grey) (10)
- Concrete pad footing with rounded edges (charcoal) (10)
- Thermally galvanised height adjustment (10)
- Stainless steel height adjustment (10)
- Glazing kit white
- Aluminium Edging Strip (13)
- Aluminium Outer Corner (4)
- Roof Duct, Round (included)
- Larch/Douglas windows and doors (untreated)



OSLO - FLAT ROOF TYPE 12

Oslo L type 12 W903xD380xH272cm
 Planed larch/douglas, dried, top quality and core-free. The windows and doors are of untreated spruce.
42.7972 Weatherboard profile planks, untreated
42.7972ZW Weatherboard profile planks, black

Oslo XL type 12 W1303xD430xH272cm
 Planed larch/douglas, dried, top quality and core-free. The windows and doors are of untreated spruce.
42.7980 Weatherboard profile planks, untreated
42.7980ZW Weatherboard profile planks, black

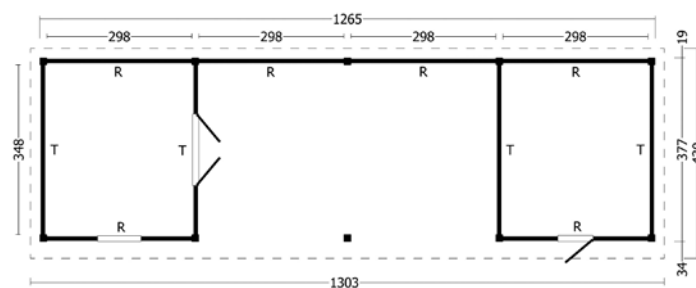
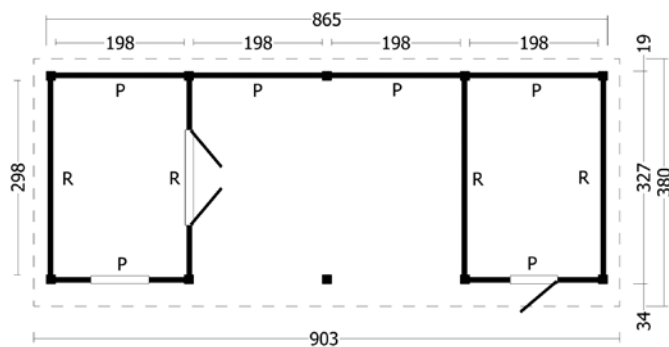

- Optional extra's**
 EPDM (included)
 Concrete pad footing with bevelled edges (charcoal) (10)
 Sinking prevention (10)
 Concrete pad footing with rounded edges (grey) (10)
 Concrete pad footing with rounded edges (charcoal) (10)
 Thermally galvanised height adjustment (10)
 Stainless steel height adjustment (10)
 Glazing kit white
 Aluminium Edging Strip (9)
 Aluminium Outer Corner (4)
 Roof Duct, Round (included)
 Larch/Douglas windows and doors (untreated)

- Optional extra's**
 EPDM (included)
 Concrete pad footing with bevelled edges (charcoal) (10)
 Sinking prevention (10)
 Concrete pad footing with rounded edges (grey) (10)
 Concrete pad footing with rounded edges (charcoal) (10)
 Thermally galvanised height adjustment (10)
 Stainless steel height adjustment (10)
 Glazing kit white
 Aluminium Edging Strip (13)
 Aluminium Outer Corner (4)
 Roof Duct, Round (included)
 Larch/Douglas windows and doors (untreated)

Modular roofs, larch/douglas Hamar

Design your very own Roof, Garden House, Carport, Sauna, Garage, Open-Sided Barn and more with this unique modular system!

All components are delivered made to measure (with the exception of the fences and sloping walls).

You can extend your basic pack by using an extension set. This can be shortened if required.

You can create numerous variations by adding walls, doors and windows.

All modules are made from top quality dried, planed, and core-free larch/douglas wood and supplied including the necessary fitting kits along with a comprehensive construction manual.

To make it easier for you, we have put together some combinations from the Bergen.
If you can't find your favourite model amongst these, then it is also possible to design your own.

Step 1
Choose the basic model
(length 500cm)

Step 2
Choose the extension
set(s)
(length 240cm)

Step 3
Choose the wall set
(plus slat set)

Step 4
Choose the windows and
doors
(plus adjustment frame)

Step 5
Choose possible options
(foundation, concrete pad
footing, etc.)

For full pricing options, please contact your Authorised Tuindeco Dealer.

Hamar L (columns 14.5x14.5cm / girders 4.5x14.5 / walk-through height 230cm)

42.7920		Hamar L basic package	W480xD400xH348cm
42.7921		Hamar L extension set	W212xD400xH348cm
42.7934	untreated	Hamar L lap board rear/front wall module P	W198xH230cm
42.7935	black	Hamar L lap board rear/front wall module P	W198xH230cm
42.7949		Hamar L slat set for wall module P	W198cm
42.7938	untreated	Hamar L lap board sidewall module R	W298xH230cm
42.7939	black	Hamar L lap board sidewall module R	W298xH230cm
42.7950		Hamar L slat set for wall module R	W298cm
42.7944	untreated	Hamar L lap board sidewall top facade module Y	W298cm
42.7945	black	Hamar L lap board sidewall top facade module Y	W298cm
42.7953		Adjustment frame for single door/single window	
42.7954		Adjustment frame for double door/double window	
42.8071		Glass partition type P B198xH230cm	
42.8072		Glass partition type R B298xH230cm	

Hamar XL (columns 14.5x14.5cm / girders 4.5x14.5cm / walk-through height 230cm)

42.7925		Hamar XL basic package	W680xD450xH360cm
42.7926		Hamar XL extension set	W312xD450xH360cm
42.7938	untreated	Hamar XL lap board rear/front wall module R	W298xH230cm
42.7939	black	Hamar XL lap board rear/front wall module R	W298xH230cm
42.7950		Hamar XL slat set for wall module R	W298cm
42.7942	untreated	Hamar XL lap board sidewall module T	W348xH230cm
42.7943	black	Hamar XL lap board sidewall module T	W348xH348cm
42.7952		Hamar XL slat set for wall module T	W348cm
42.7930	untreated	Hamar XL Wall module G	W167x230mm
42.7931	black	Hamar XL Wall module G	W167x230mm
42.7948		Hamar XL slat set for wall module G	W167cm
42.7946	untreated	Hamar XL lap board sidewall top facade module Z	W348cm
42.7947	black	Hamar XL lap board sidewall top facade module Z	W348cm
42.7953		Adjustment frame for single door/single window	
42.7954		Adjustment frame for double door/double window	
42.8072		Glass partition type R B298xH230cm	
42.8073		Glass partition type T B348xH230cm	
42.8070		Glass partition type G B166.7xH230cm	

Options for Hamar

45.8009	Planed larch/douglas post	14.5x14.5x300cm shipped
45.8029	Planed larch/douglas post	14.5x14.5x125cm with diamond head
9.40700	Larch/douglas fencing Perfect (see page 52)	H70xW280cm
35.7650	Larch/douglas cover for fencing Perfect	4.5x13.5x280cm

At the Hamar roofing can be ordered as an option, see page 405-407

The prices mentioned on the following pages include untreated spruce windows and doors

You can change the windows and doors at a surcharge or lower price, see page 220, 401-403

For partition walls, you will need to order an extra roof beam once (45.8002)

All other options can be found from page 400

For glass walls and wall modules see pages 219



HAMAR - APEX ROOF TYPE 1

Hamar L type 1 W478xD395xH348cm
 Planed larch/douglas, dried, top quality and core-free.
42.7920

Hamar XL type 1 W678xD445xH360cm
 Planed larch/douglas, dried, top quality and core-free.
42.7925

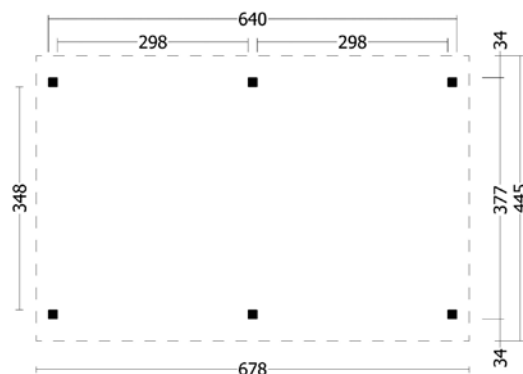
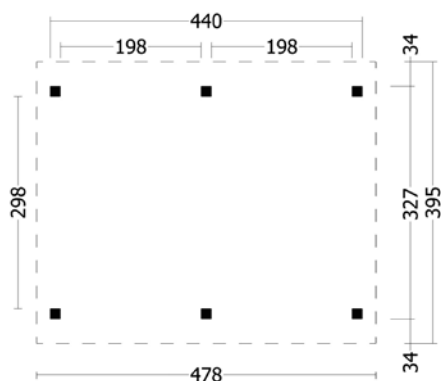

Optional extra's

- Roof shingles, straight (24m²) (8)
- Roof shingles, beavertail (24m²) (8)
- Roof shingles, hexagonal (24m²) (8)
- Roof tile profile boards (30m²) (30)
- Aquapan
- Gutter set plastic 100mm (charcoal)
- Gutter set thermally galvanised 125mm
- Concrete pad footing with bevelled edges (charcoal) (6)
- Sinking prevention (6)
- Concrete pad footing with rounded edges (grey) (6)
- Concrete pad footing with rounded edges (charcoal) (6)
- Thermally galvanised height adjustment (6)
- Stainless steel height adjustment (6)
- Roof covering kit (3)

Optional extra's

- Roof shingles, straight (39m²) (13)
- Roof shingles, beavertail (39m²) (13)
- Roof shingles, hexagonal (39m²) (13)
- Roof tile profile boards (40m²) (40)
- Aquapan
- Gutter set plastic 100mm (charcoal)
- Gutter set thermally galvanised 125mm
- Concrete pad footing with bevelled edges (charcoal) (6)
- Sinking prevention (6)
- Concrete pad footing with rounded edges (grey) (6)
- Concrete pad footing with rounded edges (charcoal) (6)
- Thermally galvanised height adjustment (6)
- Stainless steel height adjustment (6)
- Roof covering kit (4)



HAMAR - APEX ROOF TYPE 2

Hamar L type 2 W478xD395xH348cm

Planed larch/douglas, dried, top quality and core-free.

42.7922 Weatherboard profile planks, untreated

42.7922ZW Weatherboard profile planks, black

Hamar XL type 2 W678xD445xH360cm

Planed larch/douglas, dried, top quality and core-free.

42.7927 Weatherboard profile planks, untreated

42.7927ZW Weatherboard profile planks, black

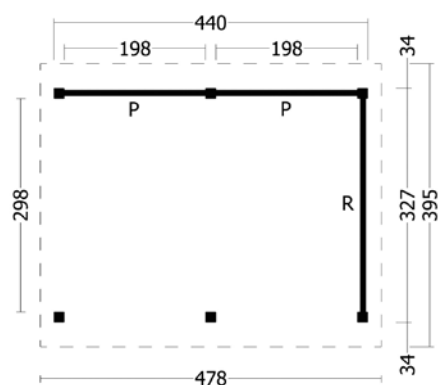

Optional extra's

- Roof shingles, straight (24m²) (8)
- Roof shingles, beavertail (24m²) (8)
- Roof shingles, hexagonal (24m²) (8)
- Roof tile profile boards (30m²) (30)
- Aquapan
- Gutter set plastic 100mm (charcoal)
- Gutter set thermally galvanised 125mm
- Concrete pad footing with bevelled edges (charcoal) (6)
- Sinking prevention (6)
- Concrete pad footing with rounded edges (grey) (6)
- Concrete pad footing with rounded edges (charcoal) (6)
- Thermally galvanised height adjustment (6)
- Stainless steel height adjustment (6)
- Roof covering kit (3)

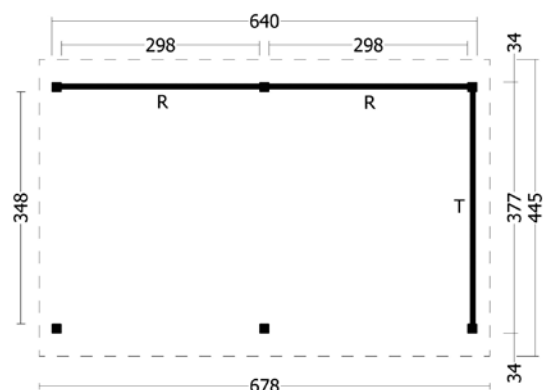

Optional extra's

- Roof shingles, straight (39m²) (13)
- Roof shingles, beavertail (39m²) (13)
- Roof shingles, hexagonal (39m²) (13)
- Roof tile profile boards (40m²) (40)
- Aquapan
- Gutter set plastic 100mm (charcoal)
- Gutter set thermally galvanised 125mm
- Concrete pad footing with bevelled edges (charcoal) (6)
- Sinking prevention (6)
- Concrete pad footing with rounded edges (grey) (6)
- Concrete pad footing with rounded edges (charcoal) (6)
- Thermally galvanised height adjustment (6)
- Stainless steel height adjustment (6)
- Roof covering kit (4)



HAMAR - APEX ROOF TYPE 3

Hamar L type 3 W478xD395xH348cm
 Planed larch/douglas, dried, top quality and core-free. The windows and doors are of untreated spruce.
42.7923 Weatherboard profile planks, untreated
42.7923ZW Weatherboard profile planks, black

Hamar XL type 3 W678xD445xH360cm
 Planed larch/douglas, dried, top quality and core-free. The windows and doors are of untreated spruce.
42.7928 Weatherboard profile planks, untreated
42.7928ZW Weatherboard profile planks, black

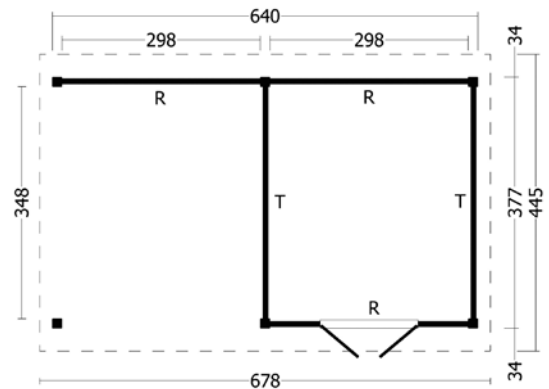
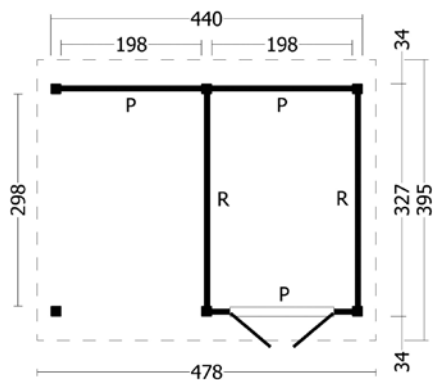

Optional extra's

- Roof shingles, straight (24m²) (8)
- Roof shingles, beavertail (24m²) (8)
- Roof shingles, hexagonal (24m²) (8)
- Roof tile profile boards (30m²) (30)
- Aquapan
- Gutter set plastic 100mm (charcoal)
- Gutter set thermally galvanised 125mm
- Concrete pad footing with bevelled edges (charcoal) (6)
- Sinking prevention (6)
- Concrete pad footing with rounded edges (grey) (6)
- Concrete pad footing with rounded edges (charcoal) (6)
- Thermally galvanised height adjustment (6)
- Stainless steel height adjustment (6)
- Roof covering kit (3)
- Glazing kit white
- Larch/Douglas windows and doors (untreated)

Optional extra's

- Roof shingles, straight (39m²) (13)
- Roof shingles, beavertail (39m²) (13)
- Roof shingles, hexagonal (39m²) (13)
- Roof tile profile boards (40m²) (40)
- Aquapan
- Gutter set plastic 100mm (charcoal)
- Gutter set thermally galvanised 125mm
- Concrete pad footing with bevelled edges (charcoal) (6)
- Sinking prevention (6)
- Concrete pad footing with rounded edges (grey) (6)
- Concrete pad footing with rounded edges (charcoal) (6)
- Thermally galvanised height adjustment (6)
- Stainless steel height adjustment (6)
- Roof covering kit (4)
- Glazing kit white
- Larch/Douglas windows and doors (untreated)



HAMAR - APEX ROOF TYPE 4

Hamar L type 4 W478xD395xH348cm
 Planed larch/douglas, dried, top quality and core-free. The windows and doors are of untreated spruce.
42.7924 Weatherboard profile planks, untreated
42.7924ZW Weatherboard profile planks, black

Hamar XL type 4 W678xD445xH360cm
 Planed larch/douglas, dried, top quality and core-free. The windows and doors are of untreated spruce.
42.7929 Weatherboard profile planks, untreated
42.7929ZW Weatherboard profile planks, black

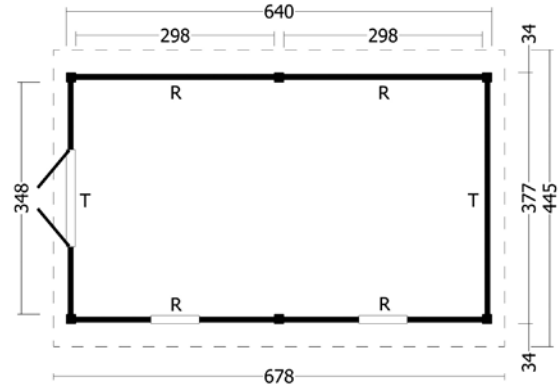
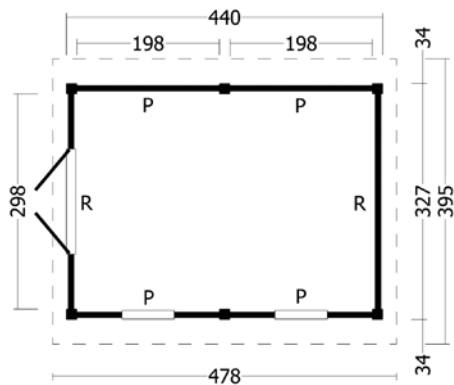

Optional extra's

- Roof shingles, straight (24m²) (8)
- Roof shingles, beavertail (24m²) (8)
- Roof shingles, hexagonal (24m²) (8)
- Roof tile profile boards (30m²) (30)
- Aquapan
- Gutter set plastic 100mm (charcoal)
- Gutter set thermally galvanised 125mm
- Concrete pad footing with bevelled edges (charcoal) (6)
- Sinking prevention (6)
- Concrete pad footing with rounded edges (grey) (6)
- Concrete pad footing with rounded edges (charcoal) (6)
- Thermally galvanised height adjustment (6)
- Stainless steel height adjustment (6)
- Roof covering kit (3)
- Glazing kit white
- Larch/Douglas windows and doors (untreated)

Optional extra's

- Roof shingles, straight (39m²) (13)
- Roof shingles, beavertail (39m²) (13)
- Roof shingles, hexagonal (39m²) (13)
- Roof tile profile boards (40m²) (40)
- Aquapan
- Gutter set plastic 100mm (charcoal)
- Gutter set thermally galvanised 125mm
- Concrete pad footing with bevelled edges (charcoal) (6)
- Sinking prevention (6)
- Concrete pad footing with rounded edges (grey) (6)
- Concrete pad footing with rounded edges (charcoal) (6)
- Thermally galvanised height adjustment (6)
- Stainless steel height adjustment (6)
- Roof covering kit (4)
- Glazing kit white
- Larch/Douglas windows and doors (untreated)



HAMAR - APEX ROOF TYPE 5

Hamar L type 5 W690xD395xH348cm
 Planed larch/douglas, dried, top quality and core-free.
42.7997

Hamar XL type 5 W990xD445xH360cm
 Planed larch/douglas, dried, top quality and core-free.
42.8005

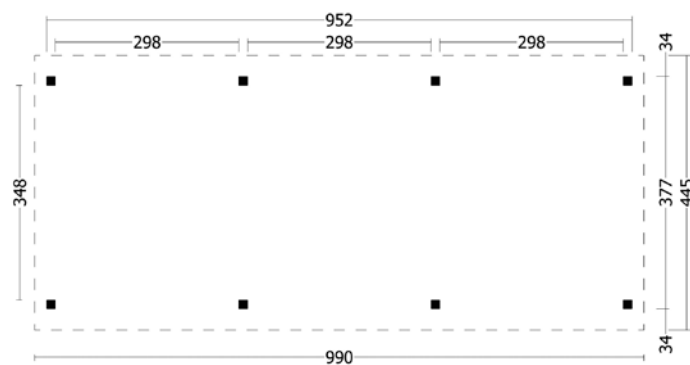
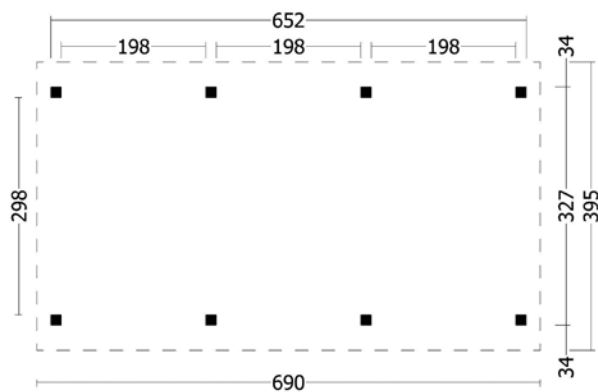

Optional extra's

- Roof shingles, straight (36m²) (12)
- Roof shingles, beavertail (36m²) (12)
- Roof shingles, hexagonal (36m²) (12)
- Roof tile profile boards (40m²) (40)
- Aquapan
- Gutter set plastic 100mm (charcoal)
- Gutter set thermally galvanised 125mm
- Concrete pad footing with bevelled edges (charcoal) (8)
- Sinking prevention (8)
- Concrete pad footing with rounded edges (grey) (8)
- Concrete pad footing with rounded edges (charcoal) (8)
- Thermally galvanised height adjustment (8)
- Stainless steel height adjustment (8)
- Roof covering kit (4)

Optional extra's

- Roof shingles, straight (54m²) (18)
- Roof shingles, beavertail (54m²) (18)
- Roof shingles, hexagonal (54m²) (18)
- Roof tile profile boards (51m²) (51)
- Aquapan
- Gutter set plastic 100mm (charcoal)
- Gutter set thermally galvanised 125mm
- Concrete pad footing with bevelled edges (charcoal) (8)
- Sinking prevention (8)
- Concrete pad footing with rounded edges (grey) (8)
- Concrete pad footing with rounded edges (charcoal) (8)
- Thermally galvanised height adjustment (8)
- Stainless steel height adjustment (8)
- Roof covering kit (6)



HAMAR - APEX ROOF TYPE 6

Hamar L type 6 W690xD395xH348cm
 Planed larch/douglas, dried, top quality and core-free.
42.7998 Weatherboard profile planks, untreated
42.7998ZW Weatherboard profile planks, black

Hamar XL type 6 W990xD445xH360cm
 Planed larch/douglas, dried, top quality and core-free.
42.8006 Weatherboard profile planks, untreated
42.8006ZW Weatherboard profile planks, black

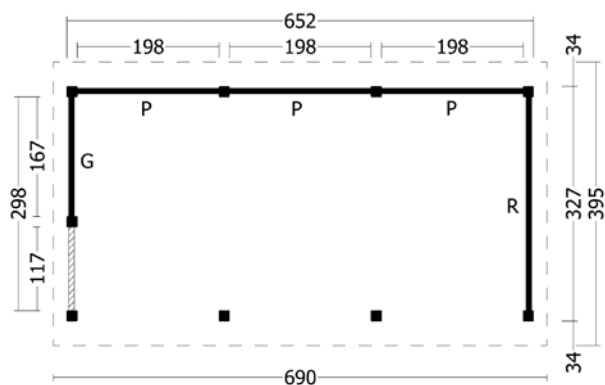

Optional extra's

- Roof shingles, straight (36m²) (12)
- Roof shingles, beavertail (36m²) (12)
- Roof shingles, hexagonal (36m²) (12)
- Roof tile profile boards (40m²) (40)
- Aquapan
- Gutter set plastic 100mm (charcoal)
- Gutter set thermally galvanised 125mm
- Concrete pad footing with bevelled edges (charcoal) (9)
- Sinking prevention (9)
- Concrete pad footing with rounded edges (grey) (9)
- Concrete pad footing with rounded edges (charcoal) (9)
- Thermally galvanised height adjustment (9)
- Stainless steel height adjustment (9)
- Roof covering kit (4)

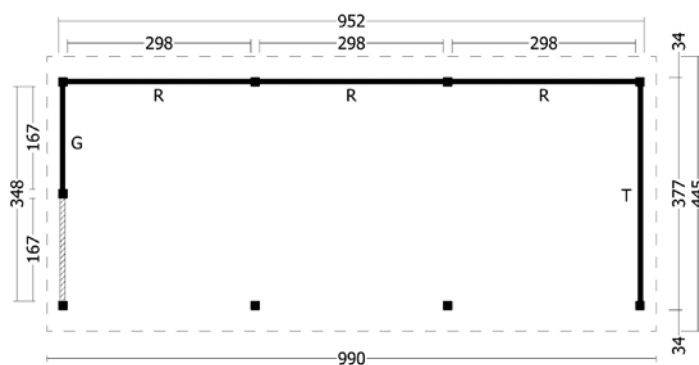

Optional extra's

- Roof shingles, straight (54m²) (18)
- Roof shingles, beavertail (54m²) (18)
- Roof shingles, hexagonal (54m²) (18)
- Roof tile profile boards (51m²) (51)
- Aquapan
- Gutter set plastic 100mm (charcoal)
- Gutter set thermally galvanised 125mm
- Concrete pad footing with bevelled edges (charcoal) (9)
- Sinking prevention (9)
- Concrete pad footing with rounded edges (grey) (9)
- Concrete pad footing with rounded edges (charcoal) (9)
- Thermally galvanised height adjustment (9)
- Stainless steel height adjustment (9)
- Roof covering kit (6)



HAMAR - APEX ROOF TYPE 7

Hamar L type 7 W690xD395xH348cm

Planed larch/douglas, dried, top quality and core-free. The windows and doors are of untreated spruce.

42.7999 Weatherboard profile planks, untreated

42.7999ZW Weatherboard profile planks, black

Hamar XL type 7 W990xD445xH360cm

Planed larch/douglas, dried, top quality and core-free. The windows and doors are of untreated spruce.

42.8007 Weatherboard profile planks, untreated

42.8007ZW Weatherboard profile planks, black

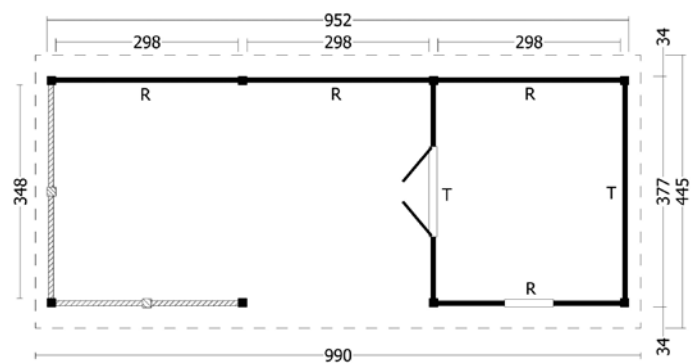
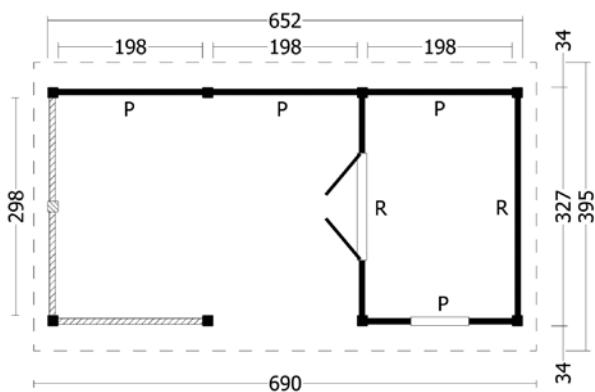

Optional extra's

- Roof shingles, straight (36m²) (12)
- Roof shingles, beavertail (36m²) (12)
- Roof shingles, hexagonal (36m²) (12)
- Roof tile profile boards (40m²) (40)
- Aquapan
- Gutter set plastic 100mm (charcoal)
- Gutter set thermally galvanised 125mm
- Concrete pad footing with bevelled edges (charcoal) (9)
- Sinking prevention (9)
- Concrete pad footing with rounded edges (grey) (9)
- Concrete pad footing with rounded edges (charcoal) (9)
- Thermally galvanised height adjustment (9)
- Stainless steel height adjustment (9)
- Roof covering kit (4)
- Glazing kit white
- Larch/Douglas windows and doors (untreated)

Optional extra's

- Roof shingles, straight (54m²) (18)
- Roof shingles, beavertail (54m²) (18)
- Roof shingles, hexagonal (54m²) (18)
- Roof tile profile boards (51m²) (51)
- Aquapan
- Gutter set plastic 100mm (charcoal)
- Gutter set thermally galvanised 125mm
- Concrete pad footing with bevelled edges (charcoal) (10)
- Sinking prevention (10)
- Concrete pad footing with rounded edges (grey) (10)
- Concrete pad footing with rounded edges (charcoal) (10)
- Thermally galvanised height adjustment (10)
- Stainless steel height adjustment (10)
- Roof covering kit (6)
- Glazing kit white
- Larch/Douglas windows and doors (untreated)



HAMAR - APEX ROOF TYPE 8

Hamar L type 8 W690xD395xH348cm
 Planed larch/douglas, dried, top quality and core-free. The windows and doors are of untreated spruce.
42.8000 Weatherboard profile planks, untreated
42.8000ZW Weatherboard profile planks, black

Hamar XL type 8 W990xD445xH360cm
 Planed larch/douglas, dried, top quality and core-free. The windows and doors are of untreated spruce.
42.8008 Weatherboard profile planks, untreated
42.8008ZW Weatherboard profile planks, black

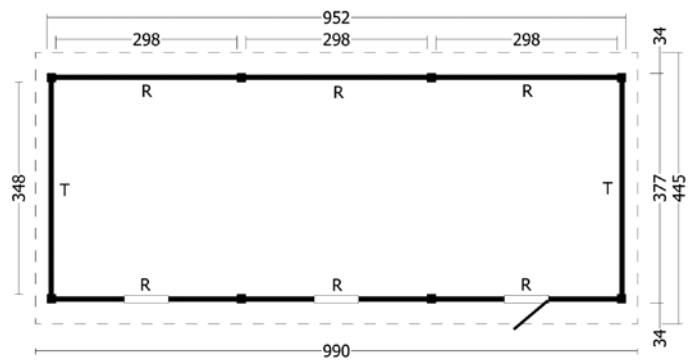
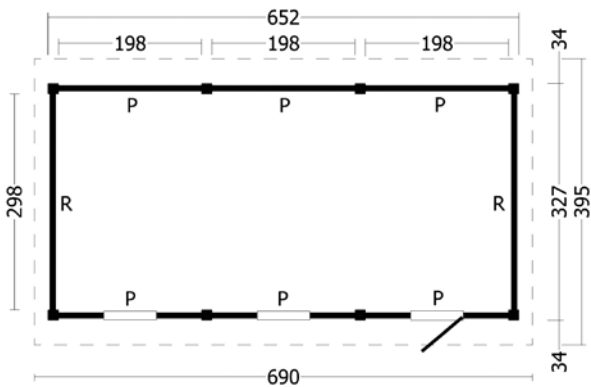

Optional extra's

- Roof shingles, straight (36m²) (12)
- Roof shingles, beavertail (36m²) (12)
- Roof shingles, hexagonal (36m²) (12)
- Roof tile profile boards (40m²) (40)
- Aquapan
- Gutter set plastic 100mm (charcoal)
- Gutter set thermally galvanised 125mm
- Concrete pad footing with bevelled edges (charcoal) (8)
- Sinking prevention (8)
- Concrete pad footing with rounded edges (grey) (8)
- Concrete pad footing with rounded edges (charcoal) (8)
- Thermally galvanised height adjustment (8)
- Stainless steel height adjustment (8)
- Roof covering kit (4)
- Glazing kit white
- Larch/Douglas windows and doors (untreated)

Optional extra's

- Roof shingles, straight (54m²) (18)
- Roof shingles, beavertail (54m²) (18)
- Roof shingles, hexagonal (54m²) (18)
- Roof tile profile boards (51m²) (51)
- Aquapan
- Gutter set plastic 100mm (charcoal)
- Gutter set thermally galvanised 125mm
- Concrete pad footing with bevelled edges (charcoal) (8)
- Sinking prevention (8)
- Concrete pad footing with rounded edges (grey) (8)
- Concrete pad footing with rounded edges (charcoal) (8)
- Thermally galvanised height adjustment (8)
- Stainless steel height adjustment (8)
- Roof covering kit (6)
- Glazing kit white
- Larch/Douglas windows and doors (untreated)



HAMAR - APEX ROOF TYPE 9

Hamar L type 9 W903xD395xH348cm
 Planed larch/douglas, dried, top quality and core-free.
42.8001

Hamar XL type 9 W1303xD445xH360cm
 Planed larch/douglas, dried, top quality and core-free.
42.8009

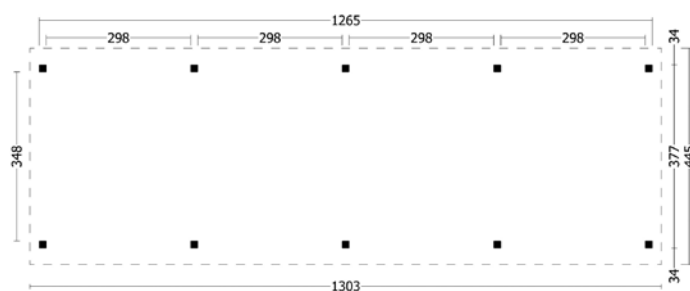
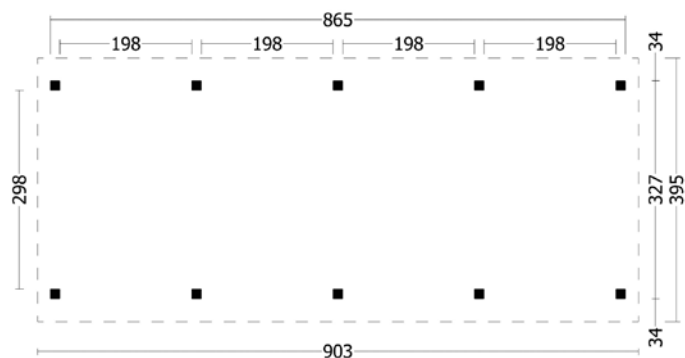

Optional extra's

- Roof shingles, straight (42m²) (14)
- Roof shingles, beavertail (42m²) (14)
- Roof shingles, hexagonal (42m²) (14)
- Roof tile profile boards (51m²) (51)
- Aquapan
- Gutter set plastic 100mm (charcoal)
- Gutter set thermally galvanised 125mm
- Concrete pad footing with bevelled edges (charcoal) (10)
- Sinking prevention (10)
- Concrete pad footing with rounded edges (grey) (10)
- Concrete pad footing with rounded edges (charcoal) (10)
- Thermally galvanised height adjustment (10)
- Stainless steel height adjustment (10)
- Roof covering kit (4)

Optional extra's

- Roof shingles, straight (66m²) (22)
- Roof shingles, beavertail (66m²) (22)
- Roof shingles, hexagonal (66m²) (22)
- Roof tile profile boards (68m²) (68)
- Aquapan
- Gutter set plastic 100mm (charcoal)
- Gutter set thermally galvanised 125mm
- Concrete pad footing with bevelled edges (charcoal) (10)
- Sinking prevention (10)
- Concrete pad footing with rounded edges (grey) (10)
- Concrete pad footing with rounded edges (charcoal) (10)
- Thermally galvanised height adjustment (10)
- Stainless steel height adjustment (10)
- Roof covering kit (7)



HAMAR - APEX ROOF TYPE 10

Hamar L type 10 W903xD395xH348cm

Planed larch/douglas, dried, top quality and core-free. The windows and doors are of untreated spruce.

42.8002 Weatherboard profile planks, untreated

42.8002ZW Weatherboard profile planks, black

Hamar XL type 10 W1303xD445xH360cm

Planed larch/douglas, dried, top quality and core-free. The windows and doors are of untreated spruce.

42.8010 Weatherboard profile planks, untreated

42.8010ZW Weatherboard profile planks, black

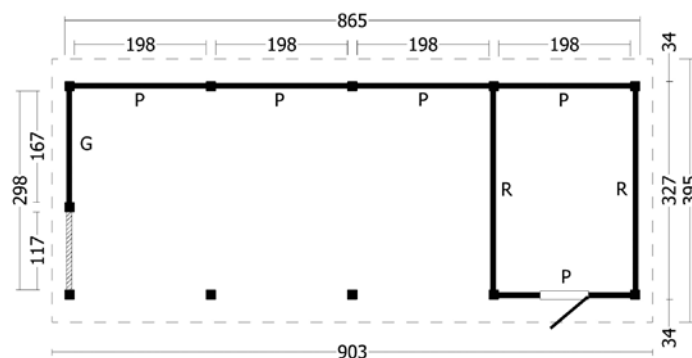

Optional extra's

- Roof shingles, straight (42m²) (14)
- Roof shingles, beavertail (42m²) (14)
- Roof shingles, hexagonal (42m²) (14)
- Roof tile profile boards (51m²) (51)
- Aquapan
- Gutter set plastic 100mm (charcoal)
- Gutter set thermally galvanised 125mm
- Concrete pad footing with bevelled edges (charcoal) (11)
- Sinking prevention (11)
- Concrete pad footing with rounded edges (grey) (11)
- Concrete pad footing with rounded edges (charcoal) (11)
- Thermally galvanised height adjustment (11)
- Stainless steel height adjustment (11)
- Roof covering kit (4)
- Larch/Douglas windows and doors (untreated)

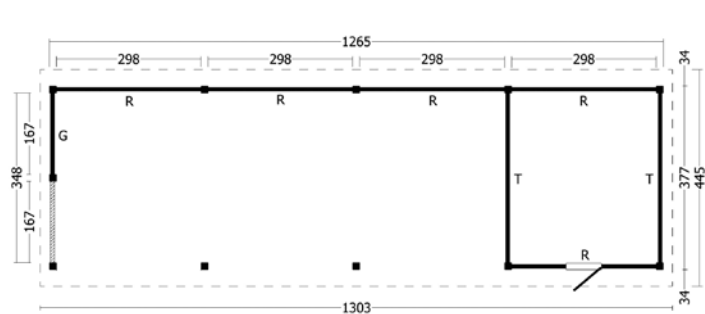

Optional extra's

- Roof shingles, straight (66m²) (22)
- Roof shingles, beavertail (66m²) (22)
- Roof shingles, hexagonal (66m²) (22)
- Roof tile profile boards (68m²) (68)
- Aquapan
- Gutter set plastic 100mm (charcoal)
- Gutter set thermally galvanised 125mm
- Concrete pad footing with bevelled edges (charcoal) (11)
- Sinking prevention (11)
- Concrete pad footing with rounded edges (grey) (11)
- Concrete pad footing with rounded edges (charcoal) (11)
- Thermally galvanised height adjustment (11)
- Stainless steel height adjustment (11)
- Roof covering kit (7)
- Larch/Douglas windows and doors (untreated)



HAMAR - APEX ROOF TYPE 11

Hamar L type 11 W903xD395xH348cm

Planed larch/douglas, dried, top quality and core-free. The windows and doors are of untreated spruce.

42.8003 Weatherboard profile planks, untreated

42.8003ZW Weatherboard profile planks, black

Hamar XL type 11 W1303xD445xH360cm

Planed larch/douglas, dried, top quality and core-free. The windows and doors are of untreated spruce.

42.8011 Weatherboard profile planks, untreated

42.8011ZW Weatherboard profile planks, black

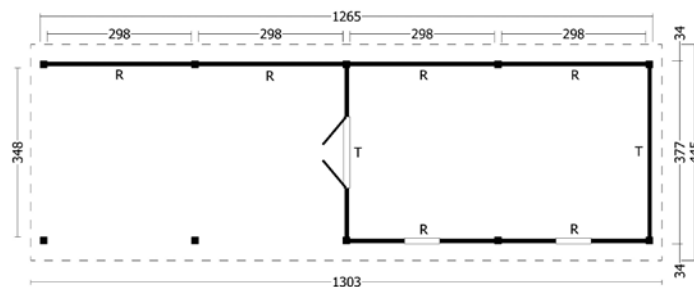
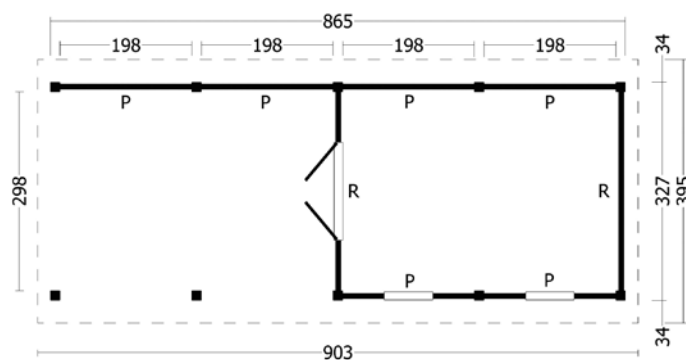

Optional extra's

- Roof shingles, straight (42m²) (14)
- Roof shingles, beavertail (42m²) (14)
- Roof shingles, hexagonal (42m²) (14)
- Roof tile profile boards (51m²) (51)
- Aquapan
- Gutter set plastic 100mm (charcoal)
- Gutter set thermally galvanised 125mm
- Concrete pad footing with bevelled edges (charcoal) (10)
- Sinking prevention (10)
- Concrete pad footing with rounded edges (grey) (10)
- Concrete pad footing with rounded edges (charcoal) (10)
- Thermally galvanised height adjustment (10)
- Stainless steel height adjustment (10)
- Roof covering kit (4)
- Glazing kit white
- Larch/Douglas windows and doors (untreated)

Optional extra's

- Roof shingles, straight (66m²) (22)
- Roof shingles, beavertail (66m²) (22)
- Roof shingles, hexagonal (66m²) (22)
- Roof tile profile boards (68m²) (68)
- Aquapan
- Gutter set plastic 100mm (charcoal)
- Gutter set thermally galvanised 125mm
- Concrete pad footing with bevelled edges (charcoal) (10)
- Sinking prevention (10)
- Concrete pad footing with rounded edges (grey) (10)
- Concrete pad footing with rounded edges (charcoal) (10)
- Thermally galvanised height adjustment (10)
- Stainless steel height adjustment (10)
- Roof covering kit (7)
- Glazing kit white
- Larch/Douglas windows and doors (untreated)



HAMAR - APEX ROOF TYPE 12

Hamar L type 12 W903xD395xH348cm
 Planed larch/douglas, dried, top quality and core-free. The windows and doors are of untreated spruce.
42.8004 Weatherboard profile planks, untreated
42.8004ZW Weatherboard profile planks, black

Hamar XL type 12 W1303xD445xH360cm
 Planed larch/douglas, dried, top quality and core-free. The windows and doors are of untreated spruce.
42.8012 Weatherboard profile planks, untreated
42.8012ZW Weatherboard profile planks, black

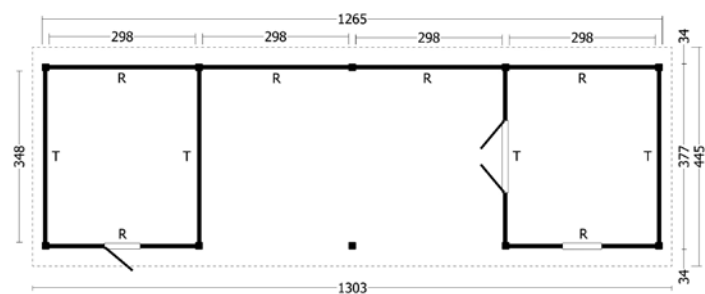
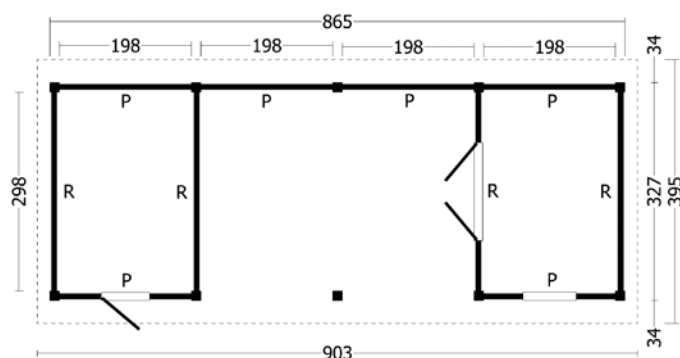

Optional extra's

- Roof shingles, straight (42m²) (14)
- Roof shingles, beavertail (42m²) (14)
- Roof shingles, hexagonal (42m²) (14)
- Roof tile profile boards (51m²) (51)
- Aquapan
- Gutter set plastic 100mm (charcoal)
- Gutter set thermally galvanised 125mm
- Concrete pad footing with bevelled edges (charcoal) (10)
- Sinking prevention (10)
- Concrete pad footing with rounded edges (grey) (10)
- Concrete pad footing with rounded edges (charcoal) (10)
- Thermally galvanised height adjustment (10)
- Stainless steel height adjustment (10)
- Roof covering kit (4)
- Glazing kit white
- Larch/Douglas windows and doors (untreated)

Optional extra's

- Roof shingles, straight (66m²) (22)
- Roof shingles, beavertail (66m²) (22)
- Roof shingles, hexagonal (66m²) (22)
- Roof tile profile boards (68m²) (68)
- Aquapan
- Gutter set plastic 100mm (charcoal)
- Gutter set thermally galvanised 125mm
- Concrete pad footing with bevelled edges (charcoal) (10)
- Sinking prevention (10)
- Concrete pad footing with rounded edges (grey) (10)
- Concrete pad footing with rounded edges (charcoal) (10)
- Thermally galvanised height adjustment (10)
- Stainless steel height adjustment (10)
- Roof covering kit (7)
- Glazing kit white
- Larch/Douglas windows and doors (untreated)



Industrial look Larch Glass Partitions, Windows and Doors.

Larch/ Douglas 54mm thick with fixed window rods. Laminated wood with single safety glass, including draught strips, heavy stainless steel hinges and locks. The glass partitions are supplied to size for the modular roofs Oslo, Hamar and Bergen. On the plan of the roofs you will find the corresponding letter that refers to the glass partition. The windows and doors can be installed in every wall.





Black glass partitions are also possible, price and delivery time upon request.





42.8066
Single top hinged window De Luxe
 W73xH125.7cm
 Including frame



42.8065
Double side hung window De Luxe
 W140.1xH125.7cm
 Including frame



42.8062
Double door De Luxe
 W184.4xH232cm
 Including frame and pre-milled key lock hole



Our glass panels are:
 - Quick and easy to assemble
 - Linkable window modules
 - Glass placed and sealed

Double sliding door De Luxe
 Including rails and hinge & lock system



42.8063 Sliding door
 W176xH227.4cm
42.8076 Fitting kit for sliding door
 Contains:
 Extra roof beams
 Screws

Double sliding door XL De Luxe
 Including rails and hinge & lock system



42.8074 Sliding door
 W300xH227.4cm
42.8075 Fitting kit for sliding door
 Contains:
 Extra roof beams
 Screws

De Luxe glass partition
 With adjustment frame set



42.8067 Type A
 W84.5xH230cm
42.8068 Type B
 W89.1xH230cm
42.8069 Type C
 W100.4xH230cm

De Luxe glass partition
 With adjustment frame set



42.8070 Type G
 W166.7xH230cm
42.8071 Type P
 W198xH230cm



42.8072
Fixed glass panel De Luxe Type R
3-part
 l298xH230cm
 With adjustment frame set



42.8073
Fixed glass panel De Luxe Type T
4-part
 W348xH230cm
 With adjustment frame set

New

Larch/douglas windows and doors, including frame, with single glazing for roofs and garden houses.

* LH (left-hinged) RH (right-hinged) - Please note! The dimensions of the windows and doors are rebate dimensions.



Fixed window
42.8020 W59.2xH76.2cm
 Supplied with 2 types of bars
 Excluding draft strip



Single window, small
42.7957 W72.6xH89.6cm
 Supplied with 2 types of bars
 Excluding draft strip



Single window, large
42.7956 W85.2xH125.2cm
 Supplied with 2 types of bars
 Excluding draft strip



Single door, half glass
42.7958 W81.4xH197.6cm LH*
42.7959 B81.4xH197.6cm RH*
 Including frame and pre-cut lock hole
 Supplied with 2 types of bars
 Excluding draft strip



Double door
42.7960 W154.6xH197.6cm
 Including frame and pre-cut lock hole
 Supplied with 2 types of bars
 Excluding draft strip



Single door
42.7961 W86.4xH199.6cm
 Right and left-hinged
 Excluding hardware and cylinder lock
 Excluding draft



Double door
42.7962 W164.6xH199.6cm
 Right and left-hinged
 Excluding hardware and cylinder lock
 Excluding draft strip

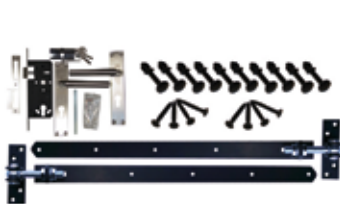

42.7963
Hardware set, black for single braced door, Larch/Douglas
 Including cylinder lock

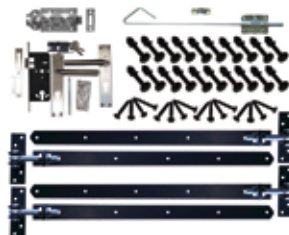

42.7964
Hardware set, black for double braced door, Larch/Douglas
 Including cylinder lock



42.7955
Draft strip, roll of 6m
 for larch/douglas structures
 To be used with above windows and doors



Why a Tuindeco Log Cabin?

Top class Northern European spruce wood

Artificially dried to 14-18%

Side heights at least 200cm

Clear construction instructions

Doors made from at least 3.2cm beam wood

Roof boards at least 1.6cm

Real glass 4cm (thicker models double glazing)

Extra wall layers easy to order

Wide range of extra windows and doors

Doors with at least 3 hinges

Wide range of roof coverings

Solid cylinder locks

Wind- and watertight straight corner connections

Short delivery times due to large stocks

Can be ordered impregnated or coated

More than 150 models in all sizes and wood thicknesses

Wide range of fittings

Door height, including frame always at least 180cm

No mixed types of wood

Bespoke possible





Vincent - Garden house
 Optional roofing felt (6.5m²)
 Optional roof shingles, straight (6m²)
 Optional roof shingles, beavertail (6m²)
 Optional roof shingles, hexagonal (6m²)

Specifications:

Article no.....40.0120
 Wood thickness 16mm
 Wood type Impregnated, dried spruce
 Dimensions 180x135cm
 Foundation size 180x135cm
 Ridge height approx. 207cm
 Fitting kit included
 Wooden floor and foundation included
 Assembly delivered in wall sections

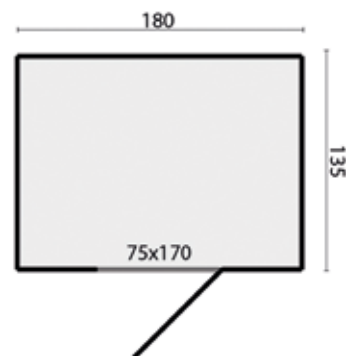

Boudewijn - Garden house
 Optional roofing felt (10m²)
 Optional roof shingles, straight (6m²)
 Optional roof shingles, beavertail (6m²)
 Optional roof shingles, hexagonal (6m²)

Specifications:

Article no.....40.0140
 Wood thickness 16mm
 Wood type Impregnated, dried spruce
 Dimensions 180x180cm
 Foundation size 180x180cm
 Ridge height approx. 207cm
 Windows 1 (fixed)
 Glass plexiglass
 Fitting kit included
 Wooden floor and foundation included
 Assembly delivered in wall sections





Hugo - Garden house
 Optional roofing felt (13m²)
 Optional roof shingles, straight (9m²)
 Optional roof shingles, beavertail (9m²)
 Optional roof shingles, hexagonal (9m²)

Specifications:

Article no.....40.0160
 Wood thickness 16mm
 Wood type Impregnated, dried spruce
 Dimensions 225x225cm
 Foundation size 225x225cm
 Ridge height approx. 212cm
 Windows 1 (fixed)
 Glass plexiglass
 Fitting kit included
 Wooden floor and foundation included
 Assembly delivered in wall sections

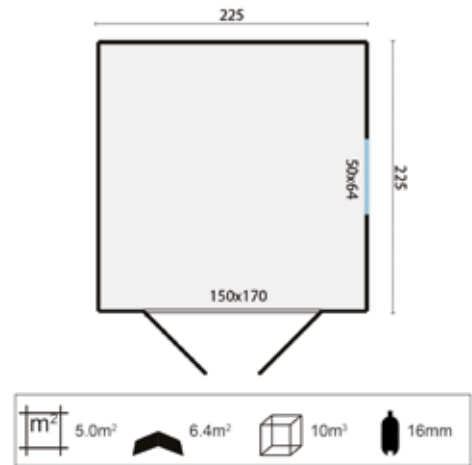

Olaf - Garden house
 Optional roofing felt (6.5m²)
 Optional EASY-roofing (10m²)

Specifications:

Article no.....40.0145
 Wood thickness 16mm
 Wood type Impregnated, dried spruce
 Dimensions 200x200cm
 Foundation size 200x200cm
 Ridge height approx. 230cm
 Windows 1 (fixed)
 Glass plexiglass
 Fitting kit included
 Wooden floor and foundation included
 Assembly delivered in wall sections

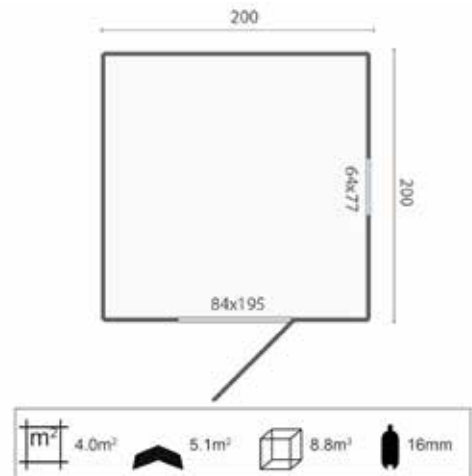

MITCH - LOG CABIN ARBOUR



- Optional roof shingles, straight (27m²)
- Optional roof shingles, beavertail (27m²)
- Optional roof shingles, hexagonal (27m²)

Specifications:

Article no.....	40.7185
Wood thickness	28mm
Wood type	green impregnated spruce
Dimensions.....	350x350cm
Foundation size	330x330cm
Ridge height	approx. 269cm

Optional extra's

- Standard green impregnated
- Stain (3)
- Carefree protect (3)
- Starter's set (Nails, air vent & storm anchor set)
- Foundation beams, impregnated 300cm (5)
- Foundation beams, hardwood 300cm (5)
- Foundation beams, synthetic 300cm (5)
- Construction girders, hardwood 4.0x20.0x300cm (5)
- Hardwood stakes with point 6.0x6.0x75cm (25)
- Gutter set plastic 65mm (charcoal)
- Gutter set plastic 100mm (charcoal)
- Gutter set thermally galvanised 125mm
- Gutter plank (impr. Spruce, necessary for fitting a gutter) (4)
- Roof covering kit (3)
- Additional wall layer
- Finial with ball

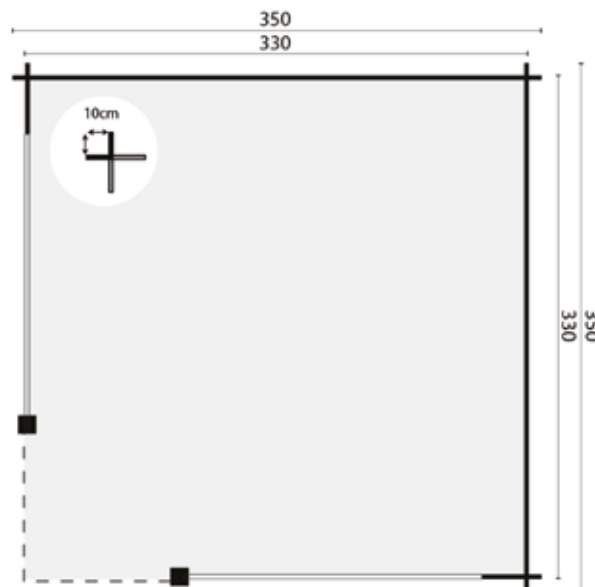

All options can be found from page 399 onwards
 Wooden floor under the Porch, see page 64 and 404

	10.9m ²		15.6m ²		29.4m ³		28mm
--	--------------------	--	--------------------	--	--------------------	--	------

BARBARA - LOG CABIN

Optional roofing felt (20m²)
 Optional EASY-roofing (25m²)
 Optional EPDM (15m²)

Specifications:

Article no..... 40.0732
 Wood thickness 28mm
 Wood type green impregnated spruce
 Dimensions..... 350x350cm
 Foundation size 330x330cm
 Ridge height approx. 222cm

Optional extra's

Standard green impregnated
 Stain (3)
 Carefree protect (3)
 Starter's set (Nails, air vent & storm anchor set)
 Foundation beams, impregnated 300cm (5)
 Foundation beams, hardwood 300cm (5)
 Foundation beams, synthetic 300cm (5)
 Construction girders, hardwood 4.0x20.0x300cm (5)
 Hardwood stakes with point 6.0x6.0x75cm (25)
 Gutter set plastic 100mm (charcoal)
 Gutter set thermally galvanised 125mm
 Roof covering kit (3)
 EPDM Adhesive
 Additional wall layer
 Aluminium Edging Strip (5)
 Aluminium Outer Corner (4)
 Roof Duct, Round

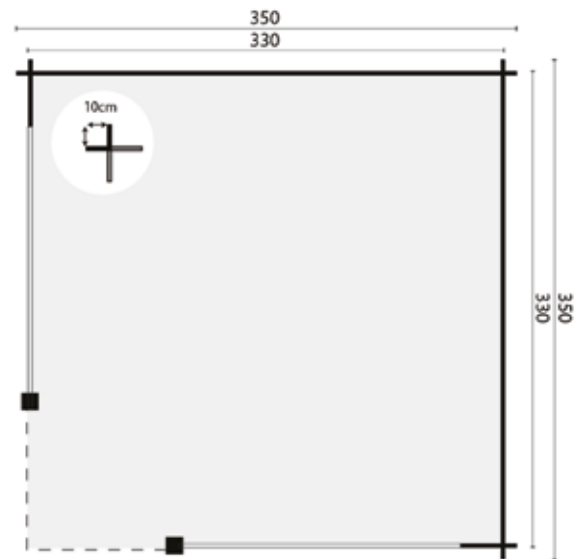

All options can be found from page 399 onwards
 Wooden floor under the Porch, see page 64 and 404

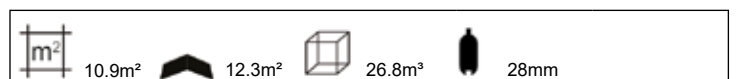

MARIT - LOG CABIN



Optional roof shingles, straight (27m²)
 Optional roof shingles, beavertail (27m²)
 Optional roof shingles, hexagonal (27m²)

Specifications:

Article no..... 40.0794
 Wood thickness 44mm
 Wood type spruce, untreated
 Dimensions.....400x400cm
 Foundation size380x380cm
 Ridge height approx. 298cm

Optional extra's

- Impregnation: Green, Brown, Silver-Grey
- Impregnating Liquid in Green, Brown, Silver-Grey or Transparent (2)
- Spray-applied base coat: White, Grey, Charcoal, Transparent
- Stain (3)
- Carefree protect (3)
- Starter's set (Nails, air vent & storm anchor set)
- Foundation beams, impregnated 300cm (6)
- Foundation beams, hardwood 300cm (6)
- Foundation beams, synthetic 300cm (6)
- Construction girders, hardwood 4.0x20.0x300cm (6)
- Hardwood stakes with point 6.0x6.0x75cm (30)
- Gutter set plastic 65mm (charcoal)
- Gutter set plastic 100mm (charcoal)
- Gutter set thermally galvanised 125mm
- Gutter plank (impr. Spruce, necessary for fitting a gutter) (5)
- Roof covering kit (4)
- Additional wall layer
- Finial with ball

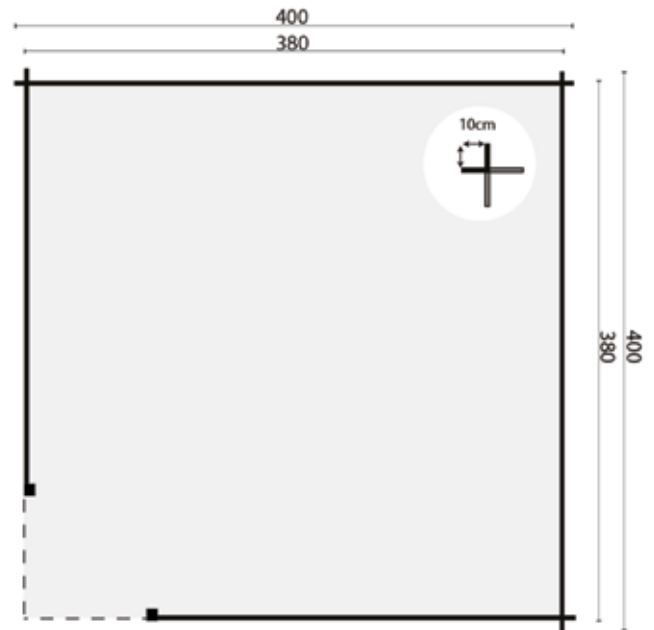

All options can be found from page 399 onwards
 Wooden floor under the Porch, see page 64 and 404

	14.4m ²		20.7m ²		36.1m ³		44mm
--	--------------------	--	--------------------	--	--------------------	--	------

KONSTANTIN - LOG CABIN

Optional roofing felt (32.5m²)
 Optional EASY-roofing (30m²)
 Optional EPDM (30m²)

Specifications:

Article no..... 40.0756
 Wood thickness 40mm
 Wood type spruce, untreated
 Dimensions..... 500x220+130cm
 Foundation size 480x330cm
 Ridge height approx. 222cm

Optional extra's

Impregnation: Green, Brown, Silver-Grey
 Impregnating Liquid in Green, Brown, Silver-Grey or Transparent (2)
 Spray-applied base coat: White, Grey, Charcoal, Transparent
 Stain (3)
 Carefree protect (3)
 Starter's set (Nails, air vent & storm anchor set)
 Foundation beams, impregnated 300cm (5)
 Foundation beams, hardwood 300cm (5)
 Foundation beams, synthetic 300cm (5)
 Construction girders, hardwood 4.0x20.0x300cm (5)
 Hardwood stakes with point 6.0x6.0x75cm (25)
 Gutter set plastic 100mm (charcoal)
 Gutter set thermally galvanised 125mm
 Roof covering kit (4)
 EPDM Adhesive
 Additional wall layer
 Aluminium Edging Strip (6)
 Aluminium Outer Corner (4)
 Roof Duct, Round

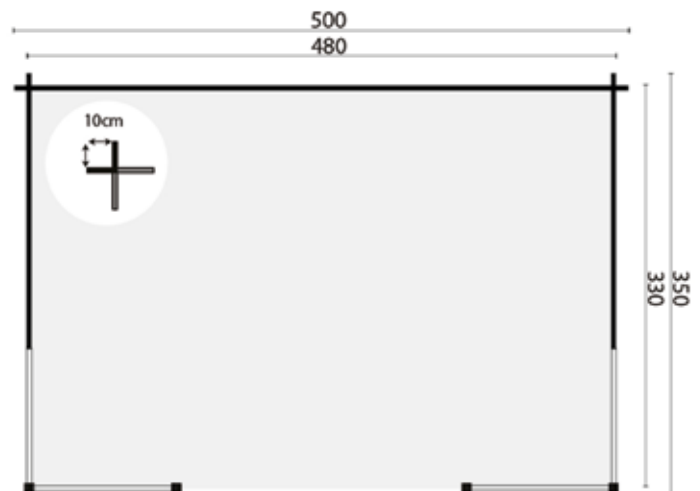

All options can be found from page 399 onwards
 Wooden floor under the Porch, see page 64 and 404

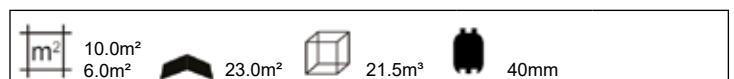

ALFSU - LOG CABIN GAZEBO

Optional roofing felt (30m²)
 Optional EASY-roofing(30m²)
 Optional EPDM (31m²)

Specifications:

Article no..... 40.0896
 Wood thickness 28mm
 Wood type spruce, untreated
 Dimensions.....598x300cm
 Foundation size598x300cm
 Ridge height approx. 261cm

Optional extra's

Impregnation: Green, Brown, Silver-Grey
 Impregnating Liquid in Green, Brown, Silver-Grey or Transparent (2)
 Spray-applied base coat: White, Grey, Charcoal, Transparent
 Stain (4)
 Carefree protect (4)
 Starter's set (Nails, air vent & storm anchor set)
 Foundation beams, impregnated 300cm (4)
 Foundation beams, hardwood 300cm (4)
 Foundation beams, synthetic 300cm (4)
 Construction girders, hardwood 4.0x20.0x300cm (4)
 Hardwood stakes with point 6.0x6.0x75cm (20)
 Concrete pad footing with bevelled edges (charcoal) (6)
 Sinking prevention (6)
 Concrete pad footing with rounded edges (grey) (6)
 Concrete pad footing with rounded edges (charcoal) (6)
 Thermally galvanised height adjustment (6)
 Stainless steel height adjustment (6)
 Roof covering kit (4)
 EPDM Adhesive
 Aluminium Edging Strip (8)
 Aluminium Outer Corner (4)
 Roof Duct, Round

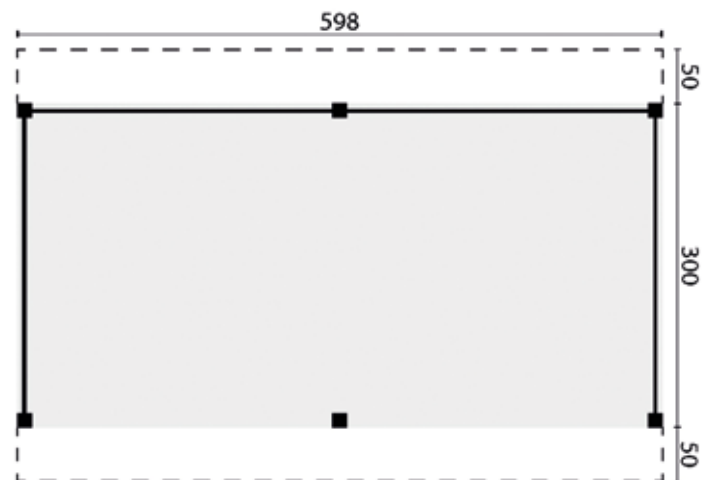

All options can be found from page 399 onwards



LADYK - LOG CABIN GAZEBO

Optional roofing felt (60m²)
 Optional EASY-roofing(60m²)
 Optional EPDM (54m²)

Specifications:

Article no..... 40.0897
 Wood thickness 28mm
 Wood type spruce, untreated
 Dimensions..... 300+600x400cm
 Foundation size900x400cm
 Ridge height approx. 261cm
 Windows 1 (can be opened)
 Glass single-glazed
 Supplied with separate bars for windows and doors
 Can also be constructed in mirror image

Optional extra's

Impregnation: Green, Brown, Silver-Grey
 Impregnating Liquid in Green, Brown, Silver-Grey or Transparent (4)
 Spray-applied base coat: White, Grey, Charcoal, Transparent
 Stain (8)
 Carefree protect (8)
 Starter's set (Nails, air vent & storm anchor set)
 Foundation beams, impregnated 300cm (10)
 Foundation beams, hardwood 300cm (10)
 Foundation beams, synthetic 300cm (10)
 Construction girders, hardwood 4.0x20.0x300cm (10)
 Hardwood stakes with point 6.0x6.0x75cm (50)
 Roof covering kit (6)
 Concrete pad footing with bevelled edges (charcoal) (8)
 Sinking prevention (8)
 Concrete pad footing with rounded edges (grey) (8)
 Concrete pad footing with rounded edges (charcoal) (8)
 Thermally galvanised height adjustment (8)
 Stainless steel height adjustment (8)
 EPDM Adhesive
 Glazing kit white
 Wooden floor 18mm (6)
 Wooden floor 18mm impregnated (6)
 Wooden floor 26mm (8)
 Wooden floor 26mm impregnated (8)
 Aluminium Edging Strip (12)
 Aluminium Outer Corner (4)
 Roof Duct, Round

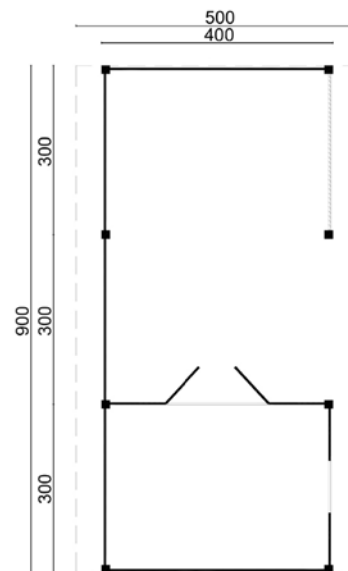

All options can be found from page 399 onwards

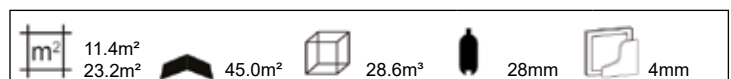

MONNE - LOG CABIN GAZEBO

Optional roofing felt (20m²)
 Optional EASY-roofing(25m²)
 Optional EPDM (22m²)

Specifications:

Article no..... 40.0895
 Wood thickness 28mm
 Wood type spruce, untreated
 Dimensions.....400x300cm
 Foundation size400x300cm
 Ridge height approx. 261cm

Optional extra's

Impregnation: Green, Brown, Silver-Grey
 Impregnating Liquid in Green, Brown, Silver-Grey or Transparent (2)
 Spray-applied base coat: White, Grey, Charcoal, Transparent
 Stain (4)
 Carefree protect (4)
 Starter's set (Nails, air vent & storm anchor set)
 Foundation beams, impregnated 300cm (4)
 Foundation beams, hardwood 300cm (4)
 Foundation beams, synthetic 300cm (4)
 Construction girders, hardwood 4.0x20.0x300cm (4)
 Hardwood stakes with point 6.0x6.0x75cm (20)
 Sinking prevention (4)
 Concrete pad footing with rounded edges (grey) (4)
 Concrete pad footing with rounded edges (charcoal) (4)
 Concrete pad footing with bevelled edges (charcoal) (4)
 Thermally galvanised height adjustment (4)
 Stainless steel height adjustment (4)
 EPDM Adhesive
 Aluminium Edging Strip (6)
 Aluminium Outer Corner (4)
 Roof Duct, Round

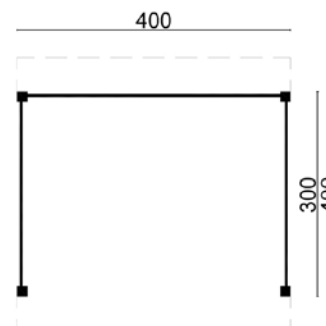

All options can be found from page 399 onwards

IRINA - LOG CABIN



Optional roofing felt (6.5m²)
 Optional roof shingles, straight (6m²)
 Optional roof shingles, beaver tail (6m²)

Optional roof shingles, hexagonal (6m²)
 Optional roof tile profile boards (8m²)*
 Optional aquapan

Specifications:

Article no..... 40.0165
 Wood thickness 19mm
 Wood type spruce, untreated
 Dimensions..... 200x155cm
 Foundation..... size 188x143cm
 Ridge height approx. 217cm

* Tip: When fitting roof tile profile boards we recommend that you also order the wide wind stops

The colour of the gutter planks and wind stops may differ somewhat

Optional extra's

Impregnation: Green, Brown, Silver-Grey
 Impregnating Liquid in Green, Brown, Silver-Grey or Transparent
 Spray-applied base coat: White, Grey, Charcoal, Transparent
 Stain (2)
 Carefree protect (2)
 Starter's set (Nails, air vent & storm anchor set)
 Foundation beams, impregnated 300cm (3)
 Foundation beams, hardwood 300cm (3)
 Foundation beams, synthetic 300cm (3)
 Construction girders, hardwood 4.0x20.0x300cm (3)
 Hardwood stakes with point 6.0x6.0x75cm (15)
 Gutter set plastic 65mm (charcoal)
 Gutter set thermally galvanised 125mm
 Gutter plank (impr. Spruce, necessary for fitting a gutter)
 Roof covering kit (2)
 Wooden floor 18mm (2)
 Wooden floor 18mm impregnated (2)
 Wooden floor 26mm (2)
 Wooden floor 26mm impregnated (2)
 Additional wall layer
 * Wide wind stop (impregnated spruce) (3)

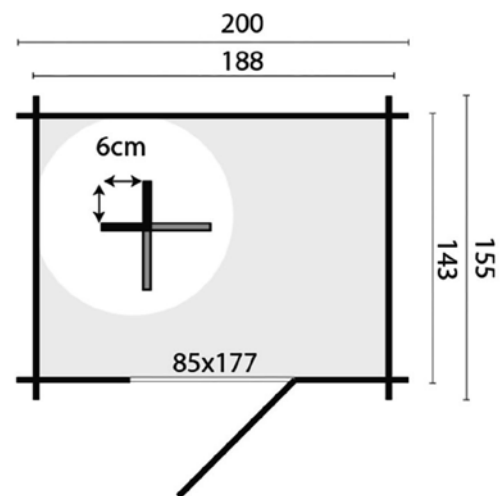

All options can be found from page 399 onwards



ARGO - LOG CABIN

Optional roofing felt (10m²)
 Optional roof shingles, straight (9m²)
 Optional roof shingles, beavertail (9m²)

Optional roof shingles, hexagonal (9m²)
 Optional roof tile profile boards (8m²)*
 Optional aquapan

Specifications:

Article no..... 40.0166
 Wood thickness 19mm
 Wood type spruce, untreated
 Dimensions..... 200x200cm
 Foundation size 188x188cm
 Ridge height approx. 217cm
 Windows 1 (fixed)
 Glass single glazing

Side window can be placed to the left or to the right

* Tip: When fitting roof tile profile boards we recommend that you also order the wide wind stops

The colour of the gutter planks and wind stops may differ somewhat

Optional extra's

Impregnation: Green, Brown, Silver-Grey
 Impregnating Liquid in Green, Brown, Silver-Grey or Transparent (2)
 Spray-applied base coat: White, Grey, Charcoal, Transparent
 Stain (3)
 Carefree protect (3)
 Starter's set (Nails, air vent & storm anchor set)
 Foundation beams, impregnated 300cm (3)
 Foundation beams, hardwood 300cm (3)
 Foundation beams, synthetic 300cm (3)
 Construction girders, hardwood 4.0x20.0x300cm (3)
 Hardwood stakes with point 6.0x6.0x75cm (15)
 Gutter set plastic 65mm (charcoal)
 Gutter set thermally galvanised 125mm
 Gutter plank (impr. Spruce, necessary for fitting a gutter) (2)
 Roof covering kit (2)
 Glazing kit white
 Wooden floor 18mm (2)
 Wooden floor 18mm impregnated (2)
 Wooden floor 26mm (2)
 Wooden floor 26mm impregnated (2)
 Additional wall layer
 * Wide wind stop (impregnated spruce) (3)

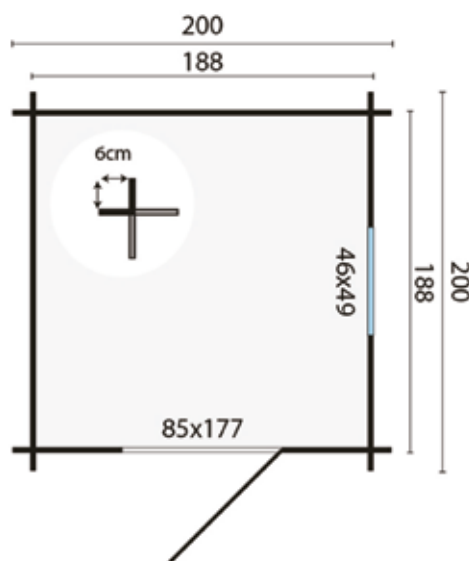

All options can be found from page 399 onwards

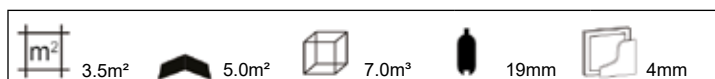

VALERY - LOG CABIN

Optional roofing felt (16.5m²)
 Optional roof shingles, straight (9m²)
 Optional roof shingles, beavertail (9m²)

Optional roof shingles, hexagonal (9m²)
 Optional roof tile profile boards (12m²)*
 Optional aquapan

Specifications:

Article no..... 40.0168
 Wood thickness 19mm
 Wood type spruce, untreated
 Dimensions..... 245x245cm
 Foundation size 233x233cm
 Ridge height approx. 216cm
 Windows 1 (fixed)
 Glass single glazing

Side window can be placed to the left or to the right

* Tip: When fitting roof tile profile boards we recommend that you also order the wide wind stops

The colour of the gutter planks and wind stops may differ somewhat

Optional extra's

Impregnation: Green, Brown, Silver-Grey
 Impregnating Liquid in Green, Brown, Silver-Grey or Transparent (2)
 Spray-applied base coat: White, Grey, Charcoal, Transparent
 Stain (3)
 Carefree protect (3)
 Starter's set (Nails, air vent & storm anchor set)
 Foundation beams, impregnated 300cm (4)
 Foundation beams, hardwood 300cm (4)
 Foundation beams, synthetic 300cm (4)
 Construction girders, hardwood 4.0x20.0x300cm (4)
 Hardwood stakes with point 6.0x6.0x75cm (20)
 Gutter set plastic 65mm (charcoal)
 Gutter set thermally galvanised 125mm
 Gutter plank (impr. Spruce, necessary for fitting a gutter) (2)
 Roof covering kit (2)
 Glazing kit white
 Wooden floor 18mm (3)
 Wooden floor 18mm impregnated (3)
 Wooden floor 26mm (4)
 Wooden floor 26mm impregnated (4)
 Additional wall layer
 * Wide wind stop (impregnated spruce) (4)

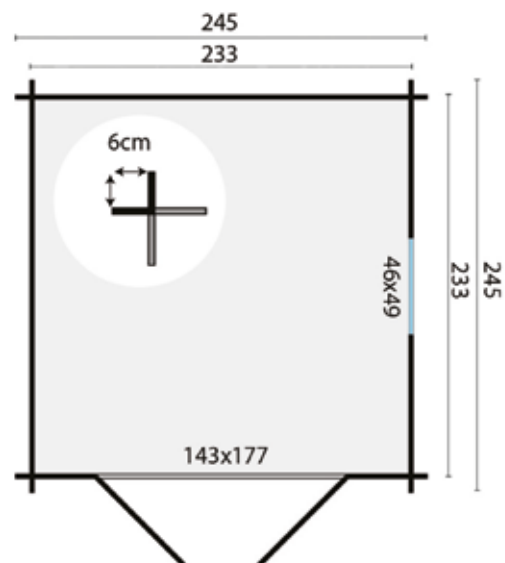

All options can be found from page 399 onwards

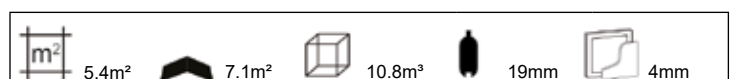

MALVA - LOG CABIN

Optional roofing felt (10m²)
 Optional roof shingles, straight (6m²)
 Optional roof shingles, beavertail (6m²)

Optional roof shingles, hexagonal (6m²)
 Optional roof tile profile boards (8m²)*
 Optional aquapan

Specifications:

Article no..... 40.0169
 Wood thickness 19mm
 Wood type spruce, untreated
 Dimensions.....260x150cm
 Foundation size248x138cm
 Ridge height approx. 245cm
 Glass single glazing
 Wooden floor included

Supplied with separate bars for windows and doors

* Tip: When fitting roof tile profile boards we recommend that you also order the wide wind stops

The colour of the gutter planks and wind stops may differ somewhat

Optional extra's

Impregnation: Green, Brown, Silver-Grey
 Impregnating Liquid in Green, Brown, Silver-Grey or Transparent (2)
 Spray-applied base coat: White, Grey, Charcoal, Transparent
 Stain (3)
 Carefree protect (3)
 Starter's set (Nails, air vent & storm anchor set)
 Foundation beams, impregnated 300cm (3)
 Foundation beams, hardwood 300cm (3)
 Foundation beams, synthetic 300cm (3)
 Construction girders, hardwood 4.0x20.0x300cm (3)
 Hardwood stakes with point 6.0x6.0x75cm (15)
 Gutter set plastic 65mm (charcoal)
 Gutter set thermally galvanised 125mm
 Gutter plank (impr. Spruce, necessary for fitting a gutter)
 Roof covering kit (2)
 Glazing kit white
 Additional wall layer
 * Wide wind stop (impregnated spruce) (4)

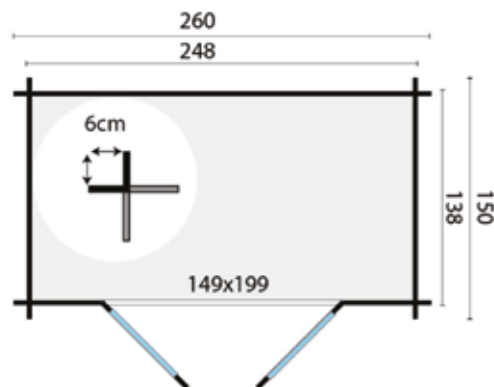

All options can be found from page 399

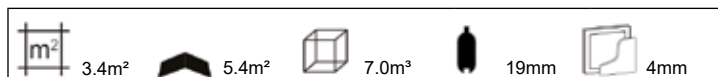

RICHARD - LOG CABIN

Optional roofing felt (10m²)
 Optional roof shingles, straight (9m²)
 Optional roof shingles, beavertail (9m²)

Optional roof shingles, hexagonal (9m²)
 Optional roof tile profile boards (8m²)*
 Optional aquapan

Specifications:

Article no..... 40.0180
 Wood thickness 28mm
 Wood type spruce, untreated
 Dimensions.....200x200cm
 Foundation size180x180cm
 Ridge height approx. 222cm
 Glass single glazing

Supplied with separate bars for windows and doors

* Tip: When fitting roof tile profile boards we recommend that you also order the wide wind stops

The colour of the gutter planks and wind stops may differ somewhat

Optional extra's

Impregnation: Green, Brown, Silver-Grey
 Impregnating Liquid in Green, Brown, Silver-Grey or Transparent (2)
 Spray-applied base coat: White, Grey, Charcoal, Transparent
 Stain (3)
 Carefree protect (3)
 Starter's set (Nails, air vent & storm anchor set)
 Foundation beams, impregnated 300cm (3)
 Foundation beams, hardwood 300cm (3)
 Foundation beams, synthetic 300cm (3)
 Construction girders, hardwood 4.0x20.0x300cm (3)
 Hardwood stakes with point 6.0x6.0x75cm (15)
 Gutter set plastic 65mm (charcoal)
 Gutter set plastic 100mm (charcoal)
 Gutter set thermally galvanised 125mm
 Gutter plank (impr. Spruce, necessary for fitting a gutter) (2)
 Skylight (only with roofing felt and roof shingles)
 Roof covering kit (2)
 Glazing kit white
 Wooden floor 18mm (2)
 Wooden floor 18mm impregnated (2)
 Wooden floor 26mm (2)
 Wooden floor 26mm impregnated (2)
 Additional wall layer
 * Wide wind stop (impregnated spruce) (3)

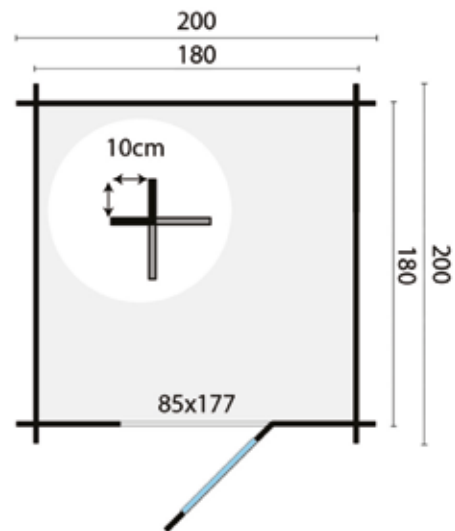

All options can be found from page 399 onwards



ROBERT - LOG CABIN

Optional roofing felt (10m²)
 Optional roof shingles, straight (9m²)
 Optional roof shingles, beaver tail (9m²)

Optional roof shingles, hexagonal (9m²)
 Optional roof tile profile boards (8m²)*
 Optional aquapan

Specifications:

Article no..... 40.0190
 Wood thickness 28mm
 Wood type spruce, untreated
 Dimensions..... 260x200cm
 Foundation size 242x182cm
 Ridge height approx. 223cm
 Glass single glazing

Supplied with separate bars for windows and doors

* Tip: When fitting roof tile profile boards we recommend that you also order the wide wind stops

The colour of the gutter planks and wind stops may differ somewhat

Optional extra's

Impregnation: Green
 Impregnation: Brown, Silver-Grey
 Impregnating Liquid in Green, Brown, Silver-Grey or Transparent (2)
 Spray-applied base coat: White, Grey, Charcoal, Transparent
 Stain (3)
 Carefree protect (3)
 Starter's set (Nails, air vent & storm anchor set)
 Foundation beams, impregnated 300cm (4)
 Foundation beams, hardwood 300cm (4)
 Foundation beams, synthetic 300cm (4)
 Construction girders, hardwood 4.0x20.0x300cm (4)
 Hardwood stakes with point 6.0x6.0x75cm (20)
 Gutter set plastic 65mm (charcoal)
 Gutter set plastic 100mm (charcoal)
 Gutter set thermally galvanised 125mm
 Gutter plank (impr. Spruce, necessary for fitting a gutter) (2)
 Skylight (only with roofing felt and roof shingles)
 Roof covering kit (2)
 Glazing kit white
 Wooden floor 18mm (2)
 Wooden floor 18mm impregnated (2)
 Wooden floor 26mm (3)
 Wooden floor 26mm impregnated (3)
 Additional wall layer
 * Wide wind stop (impregnated spruce) (4)

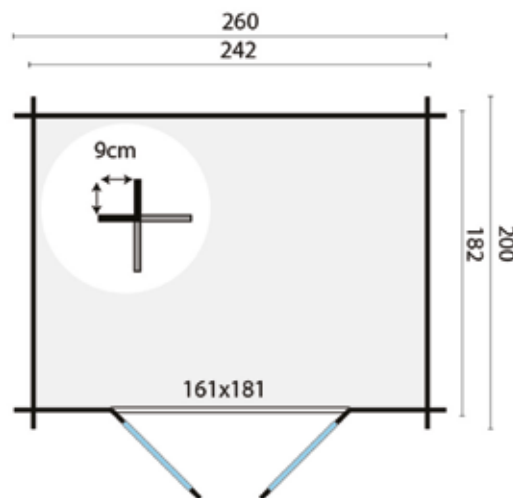

All options can be found from page 399 onwards



GITTE - LOG CABIN

Optional roofing felt (16.5m²)
 Optional roof shingles, straight (12m²)
 Optional roof shingles, beaver tail (12m²)

Optional roof shingles, hexagonal (12m²)
 Optional roof tile profile boards (14m²)*
 Optional aquapan

Specifications:

Article no..... 40.0191
 Wood thickness 28mm
 Wood type spruce, untreated
 Dimensions..... 260x260+70cm
 Foundation size 240x240cm
 Ridge height approx. 241cm
 Glass single glazing

Supplied with separate bars for windows and doors

* Tip: When fitting roof tile profile boards we recommend that you also order the wide wind stops

The colour of the gutter planks and wind stops may differ somewhat

Optional extra's

Impregnation: Green
 Impregnation: Brown, Silver-Grey
 Impregnating Liquid in Green, Brown, Silver-Grey or Transparent (2)
 Spray-applied base coat: White, Grey, Charcoal, Transparent
 Stain (3)
 Carefree protect (3)
 Starter's set (Nails, air vent & storm anchor set)
 Foundation beams, impregnated 300cm (4)
 Foundation beams, hardwood 300cm (4)
 Foundation beams, synthetic 300cm (4)
 Construction girders, hardwood 4.0x20.0x300cm (4)
 Hardwood stakes with point 6.0x6.0x75cm (20)
 Gutter set plastic 65mm (charcoal)
 Gutter set plastic 100mm (charcoal)
 Gutter set thermally galvanised 125mm
 Gutter plank (impr. Spruce, necessary for fitting a gutter) (2)
 Skylight (only with roofing felt and roof shingles)
 Roof covering kit (3)
 Glazing kit white
 Wooden floor 18mm (3)
 Wooden floor 18mm impregnated (3)
 Wooden floor 26mm (4)
 Wooden floor 26mm impregnated (4)
 Additional wall layer
 * Wide wind stop (impregnated spruce) (4)

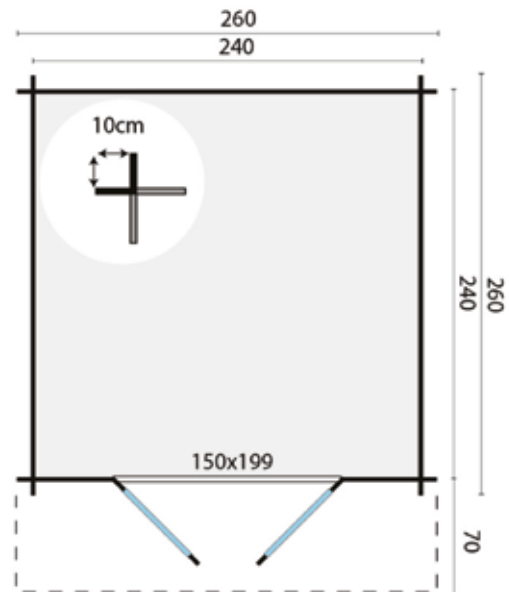

All options can be found from page 399 onwards

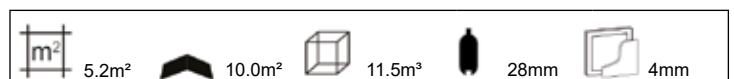

STEN - LOG CABIN



- Optional roofing felt (13m²)
- Optional roof shingles, straight (12m²)
- Optional roof shingles, beavertail (12m²)
- Optional roof shingles, hexagonal (12m²)
- Optional roof tile profile boards (14m²)*
- Optional aquapan

Specifications:

Article no..... 40.0200
 Wood thickness 28mm
 Wood type spruce, untreated
 Dimensions.....295x200cm
 Foundation size275x180cm
 Ridge height approx. 255cm
 Windows 1 (can be opened)
 Glass single glazing

Supplied with separate bars for windows and doors
 Doors and windows can be placed to the left or to the right.
 * Tip: When fitting roof tile profile boards we recommend that you also order the wide wind stops
 The colour of the gutter planks and wind stops may differ somewhat

Optional extra's

- Impregnation: Green
- Impregnation: Brown, Silver-Grey
- Impregnating Liquid in Green, Brown, Silver-Grey or Transparent (2)
- Spray-applied base coat: White, Grey, Charcoal, Transparent
- Stain (3)
- Carefree protect (3)
- Starter's set (Nails, air vent & storm anchor set)
- Foundation beams, impregnated 300cm (4)
- Foundation beams, hardwood 300cm (4)
- Foundation beams, synthetic 300cm (4)
- Construction girders, hardwood 4.0x20.0x300cm (4)
- Hardwood stakes with point 6.0x6.0x75cm (20)
- Gutter set plastic 65mm (charcoal)
- Gutter set plastic 100mm (charcoal)
- Gutter set thermally galvanised 125mm
- Gutter plank (impr. Spruce, necessary for fitting a gutter) (2)
- Skylight (only with roofing felt and roof shingles)
- Roof covering kit (3)
- Glazing kit white
- Wooden floor 18mm (3)
- Wooden floor 18mm impregnated (3)
- Wooden floor 26mm (3)
- Wooden floor 26mm impregnated (3)
- Additional wall layer
- * Wide wind stop (impregnated spruce) (4)

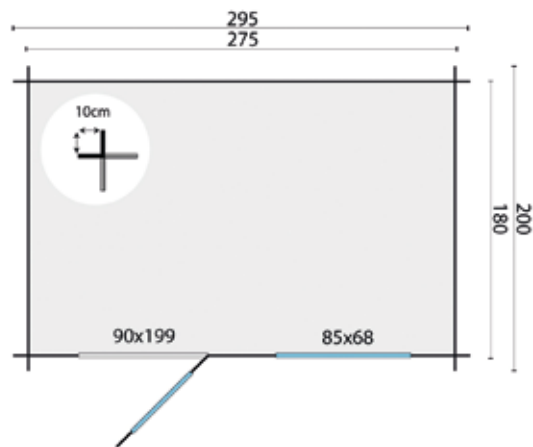

All options can be found from page 399 onwards

m² 4.6m²
 7.2m²
m³ 10.0m³
 28mm
 mm 4mm

ANJA - LOG CABIN

Optional roofing felt (13m²)
 Optional roof shingles, straight (12m²)
 Optional roof shingles, beaver tail (12m²)

Optional roof shingles, hexagonal (12m²)
 Optional roof tile profile boards (14m²)*
 Optional aquapan

Specifications:

Article no..... 40.0201
 Wood thickness 28mm
 Wood type spruce, untreated
 Dimensions..... 295x200+50cm
 Foundation size 275x180cm
 Ridge height approx. 255cm
 Glass single-glazed

Supplied with separate bars for windows and doors

* Tip: When fitting roof tile profile boards we recommend that you also order the wide wind stops

The colour of the gutter planks and wind stops may differ somewhat

Optional extra's

Impregnation: Green, Brown, Silver-Grey
 Impregnating Liquid in Green, Brown, Silver-Grey or Transparent (2)
 Spray-applied base coat: White, Grey, Charcoal, Transparent
 Stain (3)
 Carefree protect (3)
 Starter's set (Nails, air vent & storm anchor set)
 Foundation beams, impregnated 300cm (4)
 Foundation beams, hardwood 300cm (4)
 Foundation beams, synthetic 300cm (4)
 Construction girders, hardwood 4.0x20.0x300cm (4)
 Hardwood stakes with point 6.0x6.0x75cm (20)
 Gutter set plastic 65mm (charcoal)
 Gutter set plastic 100mm (charcoal)
 Gutter set thermally galvanised 125mm
 Gutter plank (impr. Spruce, necessary for fitting a gutter) (2)
 Skylight (only with roofing felt and roof shingles)
 Roof covering kit (3)
 Glazing kit white
 Wooden floor 18mm (3)
 Wooden floor 18mm impregnated (3)
 Wooden floor 26mm (3)
 Wooden floor 26mm impregnated (3)
 Additional wall layer
 * Wide wind stop (impregnated spruce) (4)

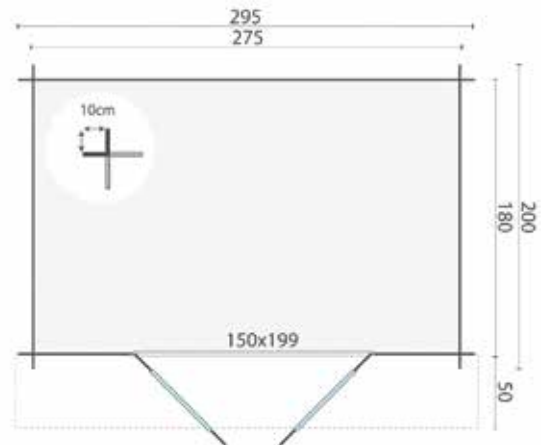

All options can be found from page 399 onwards

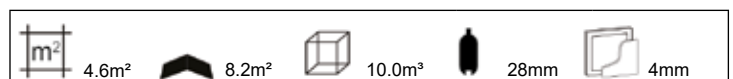

KLAIR - LOG CABIN



Optional roofing felt (20m²)
 Optional EASY-roofing (20m²)
 Optional EPDM (11m²)

Specifications:

Article no..... 40.0575
 Wood thickness 28mm
 Wood type spruce, untreated
 Dimensions..... 300x240cm
 Foundation size 280x220cm
 Ridge height approx. 234cm
 Glass single glazing
 Supplied with separate bars for doors

Optional extra's

Impregnation: Green, Brown, Silver-Grey
 Impregnating Liquid in Green, Brown, Silver-Grey or Transparent (2)
 Spray-applied base coat: White, Grey, Charcoal, Transparent
 Stain (4)
 Carefree protect (4)
 Starter's set (Nails, air vent & storm anchor set)
 Foundation beams, impregnated 300cm (4)
 Foundation beams, hardwood 300cm (4)
 Foundation beams, synthetic 300cm (4)
 Construction girders, hardwood 4.0x20.0x300cm (4)
 Hardwood stakes with point 6.0x6.0x75cm (20)
 Gutter set plastic 65mm (charcoal)
 Gutter set plastic 100mm (charcoal)
 Gutter set thermally galvanised 125mm
 Gutter plank (impr. Spruce, necessary for fitting a gutter) (2)
 Roof covering kit (3)
 Glazing kit white
 Wooden floor 18mm (4)
 Wooden floor 18mm impregnated (4)
 Wooden floor 26mm (5)
 Wooden floor 26mm impregnated (5)
 Additional wall layer

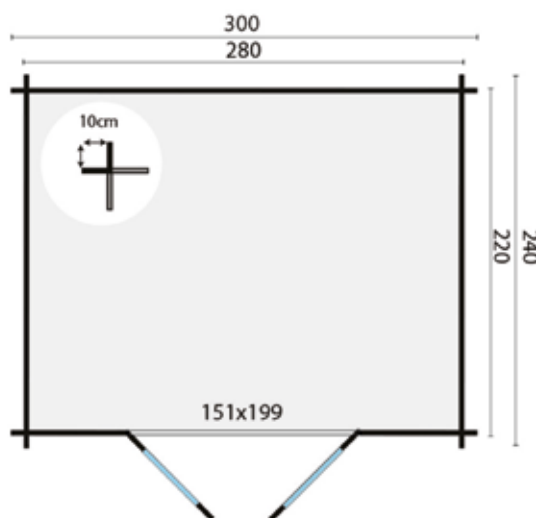

All options can be found from page 399 onwards

6.2m²
 12.1m²
 13.6m³
 28mm
 4mm

BJÖRN - LOG CABIN

Optional roofing felt (20m²)
 Optional roof shingles, straight (18m²)
 Optional roof shingles, beaver tail (18m²)

Optional roof shingles, hexagonal (18m²)
 Optional roof tile profile boards (19m²)*
 Optional aquapan

Specifications:

Article no..... 40.0300
 Wood thickness 28mm
 Wood type spruce, untreated
 Dimensions..... 300x260+80cm
 Foundation size 280x240cm
 Ridge height approx. 247cm
 Windows 1 (can be opened)
 Glass single glazing

Supplied with fixed bars for windows and doors

Doors and windows can be placed to the left or to the right.

* Tip: When fitting roof tile profile boards we recommend that you also order the wide wind stops

The colour of the gutter planks and wind stops may differ somewhat

Optional extra's

Impregnation: Green, Brown, Silver-Grey
 Impregnating Liquid in Green, Brown, Silver-Grey or Transparent (3)
 Spray-applied base coat: White, Grey, Charcoal, Transparent
 Stain (5)
 Carefree protect (5)
 Starter's set (Nails, air vent & storm anchor set)
 Foundation beams, impregnated 300cm (4)
 Foundation beams, hardwood 300cm (4)
 Foundation beams, synthetic 300cm (4)
 Construction girders, hardwood 4.0x20.0x300cm (4)
 Hardwood stakes with point 6.0x6.0x75cm (20)
 Gutter set plastic 65mm (charcoal)
 Gutter set plastic 100mm (charcoal)
 Gutter set thermally galvanised 125mm
 Gutter plank (impr. Spruce, necessary for fitting a gutter) (2)
 Skylight (only with roofing felt and roof shingles)
 Roof covering kit (3)
 Glazing kit white
 Wooden floor 18mm (4)
 Wooden floor 18mm impregnated (4)
 Wooden floor 26mm (5)
 Wooden floor 26mm impregnated (5)
 Additional wall layer
 * Wide wind stop (impregnated spruce) (4)

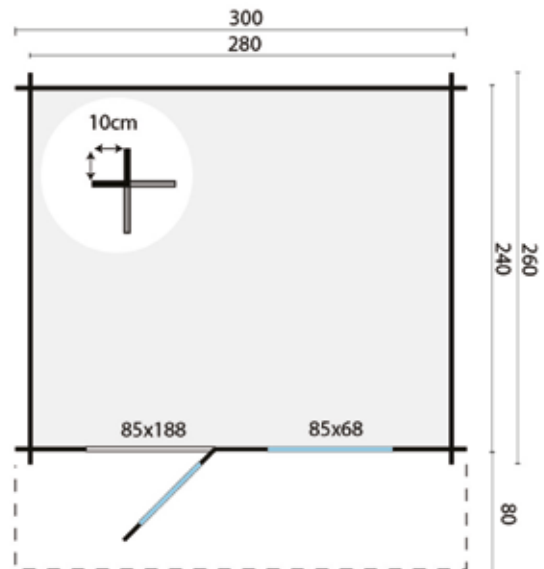

All options can be found from page 399 onwards



LARS - LOG CABIN



Optional roof shingles, straight (15m²)
 Optional roof shingles, beavertail (15m²)
 Optional roof shingles, hexagonal (15m²)

Optional roof tile profile boards (18m²)*
 Optional aquapan

Specifications:

Article no..... 40.0400
 Wood thickness 28mm
 Wood type spruce, untreated
 Dimensions..... 300+120x260cm
 Foundation size280x240cm
 Ridge height approx. 247cm
 Windows 1 (can be opened)
 Glass single glazing
 Supplied with fixed bars for windows and doors
 Can also be constructed in mirror image
 Doors and windows can be placed to the left or to the right
 * Tip: When fitting roof tile profile boards we recommend that you also order the wide wind stops
 The colour of the gutter planks and wind stops may differ somewhat

Optional extra's

Impregnation: Green, Brown, Silver-Grey
 Impregnating Liquid in Green, Brown, Silver-Grey or Transparent (2)
 Spray-applied base coat: White, Grey, Charcoal, Transparent
 Stain (4)
 Carefree protect (4)
 Starter's set (Nails, air vent & storm anchor set)
 Foundation beams, impregnated 300cm (4)
 Foundation beams, hardwood 300cm (4)
 Foundation beams, synthetic 300cm (4)
 Construction girders, hardwood 4.0x20.0x300cm (4)
 Hardwood stakes with point 6.0x6.0x75cm (20)
 Gutter set plastic 65mm (charcoal)
 Gutter set plastic 100mm (charcoal)
 Gutter set thermally galvanised 125mm
 Gutter plank (impr. Spruce, necessary for fitting a gutter) (2)
 Skylight (only with roofing felt and roof shingles)
 Roof covering kit (4)
 Glazing kit white
 Wooden floor 18mm (4)
 Wooden floor 18mm impregnated (4)
 Wooden floor 26mm (5)
 Wooden floor 26mm impregnated (5)
 Additional wall layer
 * Wide wind stop (impregnated spruce) (6)

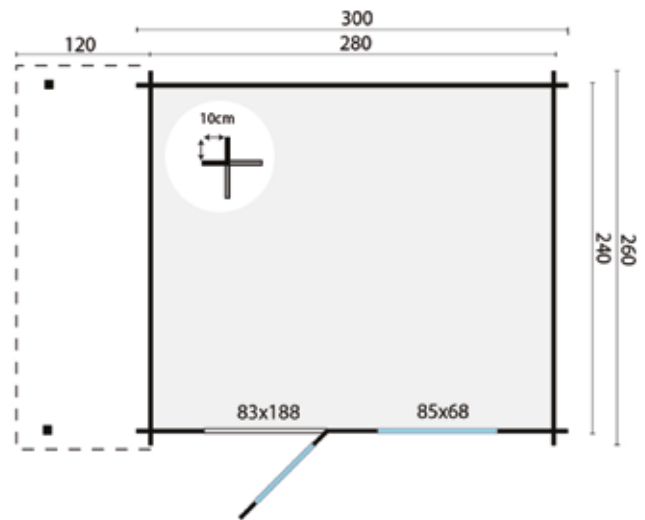

All options can be found from page 399 onwards

6.7m²
 14.0m²
 14.0m³
 28mm
 4mm

GEORG - LOG CABIN

Optional roof shingles, straight (21m²)
 Optional roof shingles, beavertail (21m²)
 Optional roof shingles, hexagonal (21m²)

Optional roof tile profile boards (24m²)*
 Optional aquapan

Specifications:

Article no..... 40.0525
 Wood thickness 28mm
 Wood type spruce, untreated
 Dimensions..... 300x260+260cm
 Foundation size 282x242cm
 Ridge height approx. 250cm
 Glass single glazing

Supplied with separate bars for windows and doors

* Tip: When fitting roof tile profile boards we recommend that you also order the wide wind stops

The colour of the gutter planks and wind stops may differ somewhat

Optional extra's

Impregnation: Green, Brown, Silver-Grey
 Impregnating Liquid in Green, Brown, Silver-Grey or Transparent (3)
 Spray-applied base coat: White, Grey, Charcoal, Transparent
 Stain (5)
 Carefree protect (5)
 Starter's set (Nails, air vent & storm anchor set)
 Foundation beams, impregnated 300cm (4)
 Foundation beams, hardwood 300cm (4)
 Foundation beams, synthetic 300cm (4)
 Construction girders, hardwood 4.0x20.0x300cm (4)
 Hardwood stakes with point 6.0x6.0x75cm (20)
 Gutter set plastic 65mm (charcoal)
 Gutter set plastic 100mm (charcoal)
 Gutter set thermally galvanised 125mm
 Gutter plank (impr. Spruce, necessary for fitting a gutter) (3)
 Skylight (only with roofing felt and roof shingles)
 Roof covering kit (4)
 Glazing kit white
 Wooden floor 18mm (4)
 Wooden floor 18mm impregnated (4)
 Wooden floor 26mm (5)
 Wooden floor 26mm impregnated (5)
 Additional wall layer
 * Wide wind stop (impregnated spruce) (4)

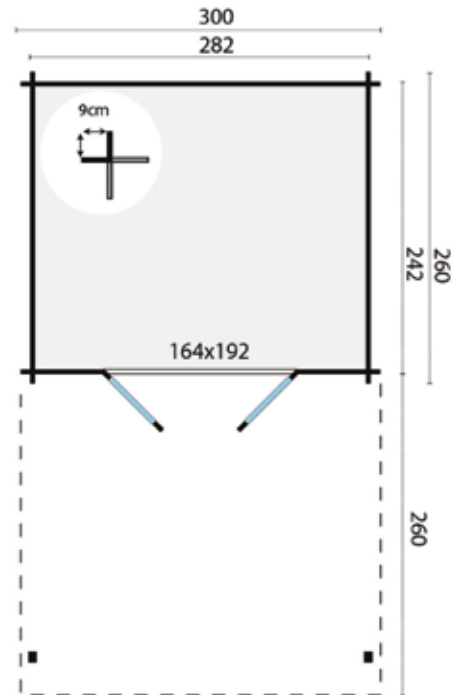

All options can be found from page 399 onwards
 Wooden floor under the Porch, see page 64 and 404

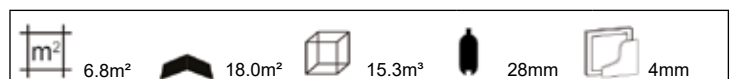

BO - LOG CABIN



Optional roofing felt (20m²)
 Optional roof shingles, straight (18m²)
 Optional roof shingles, beaver tail (18m²)

Optional roof shingles, hexagonal (18m²)
 Optional roof tile profile boards (19m²)*
 Optional aquapan

Specifications:

Article no..... 40.0250
 Wood thickness 28mm
 Wood type spruce, untreated
 Dimensions..... 300x300+70cm
 Foundation size 280x280cm
 Ridge height approx. 247cm
 Windows 1 (can be opened)
 Glass single glazing

Supplied with fixed bars for windows and doors
 Doors and windows can be placed to the left or to the right.
 * Tip: When fitting roof tile profile boards we recommend that you also order the wide wind stops
 The colour of the gutter planks and wind stops may differ somewhat

Optional extra's

- Impregnation: Green, Brown, Silver-Grey
- Impregnating Liquid in Green, Brown, Silver-Grey or Transparent (2)
- Spray-applied base coat: White, Grey, Charcoal, Transparent
- Stain (4)
- Carefree protect (4)
- Starter's set (Nails, air vent & storm anchor set)
- Foundation beams, impregnated 300cm (4)
- Foundation beams, hardwood 300cm (4)
- Foundation beams, synthetic 300cm (4)
- Construction girders, hardwood 4.0x20.0x300cm (4)
- Hardwood stakes with point 6.0x6.0x75cm (20)
- Gutter set plastic 65mm (charcoal)
- Gutter set plastic 100mm (charcoal)
- Gutter set thermally galvanised 125mm
- Gutter plank (impr. Spruce, necessary for fitting a gutter) (2)
- Skylight (only with roofing felt and roof shingles)
- Roof covering kit (3)
- Glazing kit white
- Wooden floor 18mm (4)
- Wooden floor 18mm impregnated (4)
- Wooden floor 26mm (5)
- Wooden floor 26mm impregnated (5)
- Additional wall layer
- * Wide wind stop (impregnated spruce) (4)

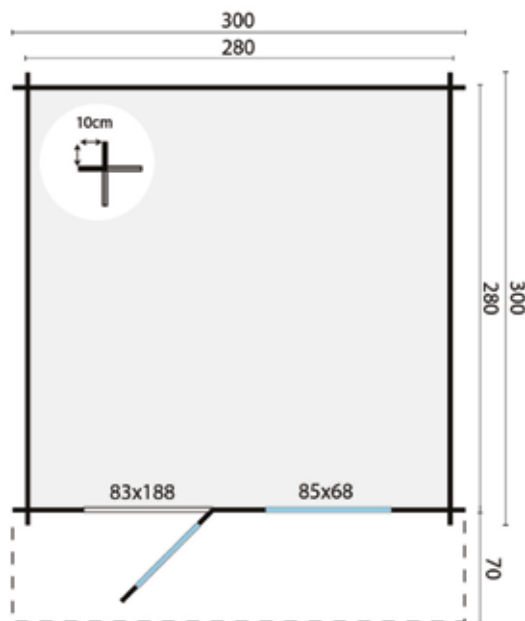

All options can be found from page 399 onwards



PERLUND - LOG CABIN

Optional roofing felt (20m²)
 Optional roof shingles, straight (18m²)
 Optional roof shingles, beaver tail (18m²)

Optional roof shingles, hexagonal (18m²)
 Optional roof tile profile boards (19m²)*
 Optional aquapan

Specifications:

Article no..... 40.0350
 Wood thickness 28mm
 Wood type spruce, untreated
 Dimensions..... 300x300+80cm
 Foundation size 280x280cm
 Ridge height approx. 247cm
 Glass single glazing

Supplied with fixed bars for windows and doors

* Tip: When fitting roof tile profile boards we recommend that you also order the wide wind stops

The colour of the gutter planks and wind stops may differ somewhat

Optional extra's

Impregnation: Green
 Impregnation: Brown, Silver-Grey
 Impregnating Liquid in Green, Brown, Silver-Grey or Transparent (2)
 Spray-applied base coat: White, Grey, Charcoal, Transparent
 Stain (4)
 Carefree protect (4)
 Starter's set (Nails, air vent & storm anchor set)
 Foundation beams, impregnated 300cm (4)
 Foundation beams, hardwood 300cm (4)
 Foundation beams, synthetic 300cm (4)
 Construction girders, hardwood 4.0x20.0x300cm (4)
 Hardwood stakes with point 6.0x6.0x75cm (20)
 Gutter set plastic 65mm (charcoal)
 Gutter set plastic 100mm (charcoal)
 Gutter set thermally galvanised 125mm
 Gutter plank (impr. Spruce, necessary for fitting a gutter) (2)
 Skylight (only with roofing felt and roof shingles)
 Roof covering kit (3)
 Glazing kit white
 Wooden floor 18mm (4)
 Wooden floor 18mm impregnated (4)
 Wooden floor 26mm (5)
 Wooden floor 26mm impregnated (5)
 Additional wall layer
 * Wide wind stop (impregnated spruce) (4)

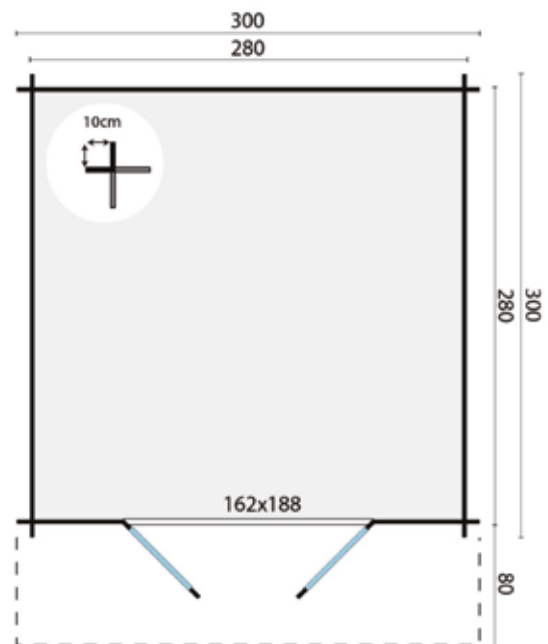

All options can be found from page 399 onwards



IDONEA - LOG CABIN

Optional roofing felt (20m²)
 Optional roof shingles, straight (15m²)
 Optional roof shingles, beaver tail (15m²)

Optional roof shingles, hexagonal (15m²)
 Optional roof tile profile boards (14m²)*
 Optional aquaplan

Specifications:

Article no..... 40.0192
 Wood thickness 28mm
 Wood type spruce, untreated
 Dimensions..... 320x260cm
 Foundation size 300x240cm
 Ridge height approx. 245cm
 Windows 4 (can be opened)
 Glass single glazing

Supplied with separate bars for windows and doors

Windows can be placed to the left or to the right

* Tip: When fitting roof tile profile boards we recommend that you also order the wide wind stops

The colour of the gutter planks and wind stops may differ somewhat

Optional extra's

Impregnation: Green, Brown, Silver-Grey

Impregnating Liquid in Green, Brown, Silver-Grey or Transparent (2)

Spray-applied base coat: White, Grey, Charcoal, Transparent

Stain (4)

Carefree protect (4)

Starter's set (Nails, air vent & storm anchor set)

Foundation beams, impregnated 300cm (4)

Foundation beams, hardwood 300cm (4)

Foundation beams, synthetic 300cm (4)

Construction girders, hardwood 4.0x20.0x300cm (4)

Hardwood stakes with point 6.0x6.0x75cm (20)

Gutter set plastic 65mm (charcoal)

Gutter set plastic 100mm (charcoal)

Gutter set thermally galvanised 125mm

Gutter plank (impr. Spruce, necessary for fitting a gutter) (2)

Skylight (only with roofing felt and roof shingles)

Roof covering kit (3)

Glazing kit white

Wooden floor 18mm (4)

Wooden floor 18mm impregnated (4)

Wooden floor 26mm (5)

Wooden floor 26mm impregnated (5)

Additional wall layer

* Wide wind stop (impregnated spruce) (4)

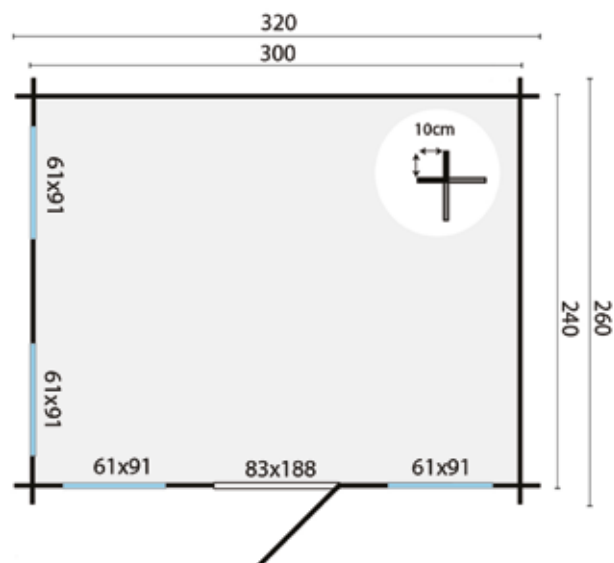

All options can be found from page 399 onwards



SKOV - LOG CABIN



Optional roof shingles, straight (18m²)
 Optional roof shingles, beaver tail (18m²)
 Optional roof shingles, hexagonal (18m²)

Optional roof tile profile boards (19m²)*
 Optional aquapan

Specifications:

Article no..... 40.0535
 Wood thickness 28mm
 Wood type spruce, untreated
 Dimensions..... 350x300cm
 Foundation size 330x280cm
 Ridge height approx. 270cm
 Windows 1 (can be opened)
 Glass single glazing

Supplied with fixed bars for windows and doors

Side window can be placed to the left or to the right

* Tip: When fitting roof tile profile boards we recommend that you also order the wide wind stops

The colour of the gutter planks and wind stops may differ somewhat

Optional extra's

Impregnation: Green, Brown, Silver-Grey

Impregnating Liquid in Green, Brown, Silver-Grey or Transparent (2)

Spray-applied base coat: White, Grey, Charcoal, Transparent

Stain (4)

Carefree protect (4)

Starter's set (Nails, air vent & storm anchor set)

Foundation beams, impregnated 300cm (5)

Foundation beams, hardwood 300cm (5)

Foundation beams, synthetic 300cm (5)

Construction girders, hardwood 4.0x20.0x300cm (5)

Hardwood stakes with point 6.0x6.0x75cm (25)

Gutter set plastic 65mm (charcoal)

Gutter set plastic 100mm (charcoal)

Gutter set thermally galvanised 125mm

Gutter plank (impr. Spruce, necessary for fitting a gutter) (2)

Skylight (only with roofing felt and roof shingles)

Roof covering kit (3)

Glazing kit white

Wooden floor 18mm (5)

Wooden floor 18mm impregnated (5)

Wooden floor 26mm (6)

Wooden floor 26mm impregnated (6)

* Wide wind stop (impregnated spruce) (8)

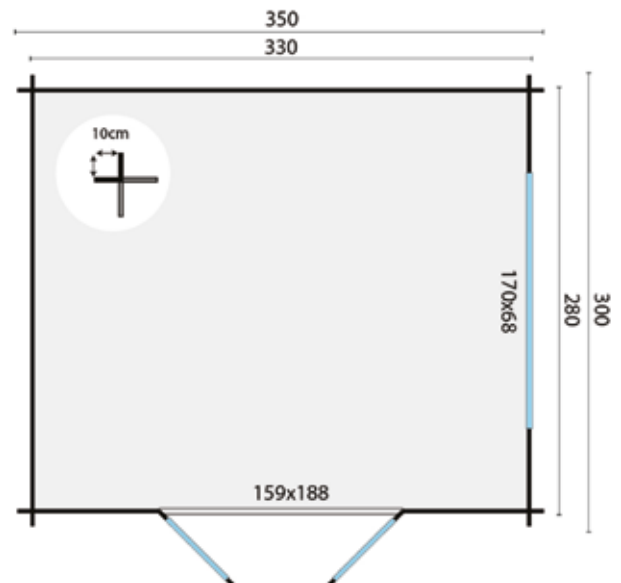

All options can be found from page 399 onwards

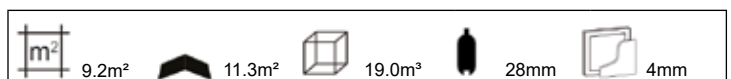

MIKA - LOG CABIN



Optional roof shingles, straight (18m²)
 Optional roof shingles, beavertail (18m²)
 Optional roof shingles, hexagonal (18m²)

Optional roof tile profile boards (23m²)*
 Optional aquapan

Specifications:

Article no..... 40.0650
 Wood thickness 28mm
 Wood type spruce, untreated
 Dimensions..... 380x300+80cm
 Foundation size 362x282cm
 Ridge height approx. 247cm
 Windows 2 (can be opened)
 Glass single glazing

Supplied with separate bars for windows and doors

* Tip: When fitting roof tile profile boards we recommend that you also order the wide wind stops

The colour of the gutter planks and wind stops may differ somewhat

Optional extra's

- Impregnation: Green, Brown, Silver-Grey
- Impregnating Liquid in Green, Brown, Silver-Grey or Transparent (2)
- Spray-applied base coat: White, Grey, Charcoal, Transparent
- Stain (4)
- Carefree protect (4)
- Starter's set (Nails, air vent & storm anchor set)
- Foundation beams, impregnated 300cm (5)
- Foundation beams, hardwood 300cm (5)
- Foundation beams, synthetic 300cm (5)
- Construction girders, hardwood 4.0x20.0x300cm (5)
- Hardwood stakes with point 6.0x6.0x75cm (25)
- Gutter set plastic 65mm (charcoal)
- Gutter set plastic 100mm (charcoal)
- Gutter set thermally galvanised 125mm
- Gutter plank (impr. Spruce, necessary for fitting a gutter) (2)
- Skylight (only with roofing felt and roof shingles)
- Roof covering kit (3)
- Glazing kit white
- Wooden floor 18mm (6)
- Wooden floor 18mm impregnated (6)
- Wooden floor 26mm (7)
- Wooden floor 26mm impregnated (7)
- Additional wall layer
- * Wide wind stop (impregnated spruce) (8)

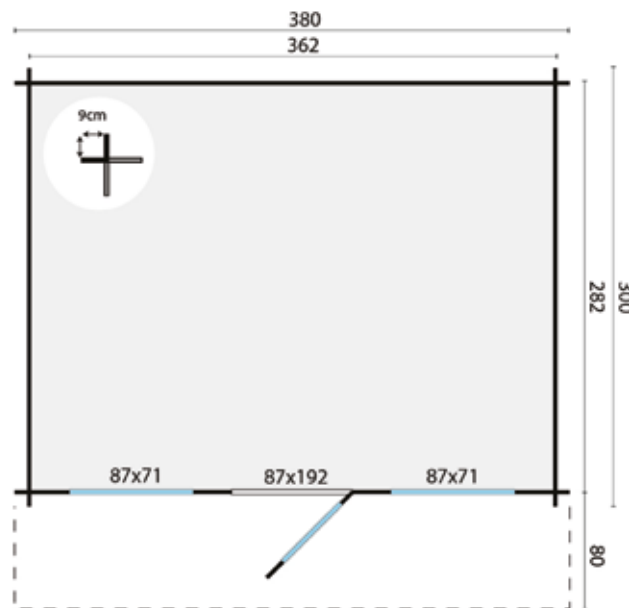

All options can be found from page 399 onwards

m² 10.2m²
▲ 16.7m²
◻ 22.5m³
● 28mm
 □ 4mm

INGMAR - LOG CABIN



Optional roof shingles, straight (18m²)
 Optional roof shingles, beaver tail (18m²)
 Optional roof shingles, hexagonal (18m²)

Optional roof tile profile boards (23m²)*
 Optional aquapan

Specifications:

Article no..... 40.0600
 Wood thickness 28mm
 Wood type spruce, untreated
 Dimensions..... 380x290+80cm
 Foundation size 362x282cm
 Ridge height approx. 253cm
 Windows 1 (can be opened)
 Glass single glazing

Supplied with separate bars for windows and doors

Doors and windows can be placed to the left or to the right.

* Tip: When fitting roof tile profile boards we recommend that you also order the wide wind stops

The colour of the gutter planks and wind stops may differ somewhat

Optional extra's

Impregnation: Green

Impregnation: Brown, Silver-Grey

Impregnating Liquid in Green, Brown, Silver-Grey or Transparent (3)

Spray-applied base coat: White, Grey, Charcoal, Transparent

Stain (5)

Carefree protect (5)

Starter's set (Nails, air vent & storm anchor set)

Foundation beams, impregnated 300cm (5)

Foundation beams, hardwood 300cm (5)

Foundation beams, synthetic 300cm (5)

Construction girders, hardwood 4.0x20.0x300cm (5)

Hardwood stakes with point 6.0x6.0x75cm (25)

Gutter set plastic 65mm (charcoal)

Gutter set plastic 100mm (charcoal)

Gutter set thermally galvanised 125mm

Gutter plank (impr. Spruce, necessary for fitting a gutter) (2)

Skylight (only with roofing felt and roof shingles)

Roof covering kit (4)

Glazing kit white

Wooden floor 18mm (5)

Wooden floor 18mm impregnated (5)

Wooden floor 26mm (7)

Wooden floor 26mm impregnated (7)

Additional wall layer

* Wide wind stop (impregnated spruce) (8)

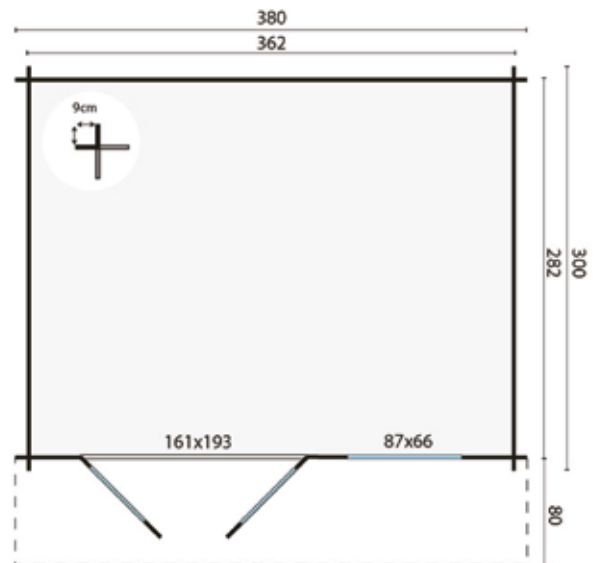

All options can be found from page 399 onwards



JUHA - LOG CABIN

Optional roofing felt (20m²)
 Optional roof shingles, straight (18m²)
 Optional roof shingles, beavertail (18m²)

Optional roof shingles, hexagonal (18m²)
 Optional roof tile profile boards (15m²)*
 Optional aquapan

Specifications:

Article no..... 40.0721
 Wood thickness 28mm
 Wood type green impregnated spruce
 Dimensions..... 400x300cm
 Foundation size 380x280cm
 Ridge height approx. 233cm
 Windows 2 (can be opened)
 Glass single glazing

Supplied with separate bars for windows and doors

* Tip: When fitting roof tile profile boards we recommend that you also order the wide wind stops

The colour of the gutter planks and wind stops may differ somewhat

Optional extra's

Standard green impregnated
 Stain (4)
 Carefree protect (4)
 Starter's set (Nails, air vent & storm anchor set)
 Foundation beams, impregnated 300cm (5)
 Foundation beams, hardwood 300cm (5)
 Foundation beams, synthetic 300cm (5)
 Construction girders, hardwood 4.0x20.0x300cm (5)
 Hardwood stakes with point 6.0x6.0x75cm (25)
 Gutter set plastic 65mm (charcoal)
 Gutter set plastic 100mm (charcoal)
 Gutter set thermally galvanised 125mm
 Gutter plank (impr. Spruce, necessary for fitting a gutter) (2)
 Skylight (only with roofing felt and roof shingles)
 Roof covering kit (4)
 Glazing kit white
 Wooden floor 18mm (5)
 Wooden floor 18mm impregnated (5)
 Wooden floor 26mm (7)
 Wooden floor 26mm impregnated (7)
 Additional wall layer
 * Wide wind stop (impregnated spruce) (8)

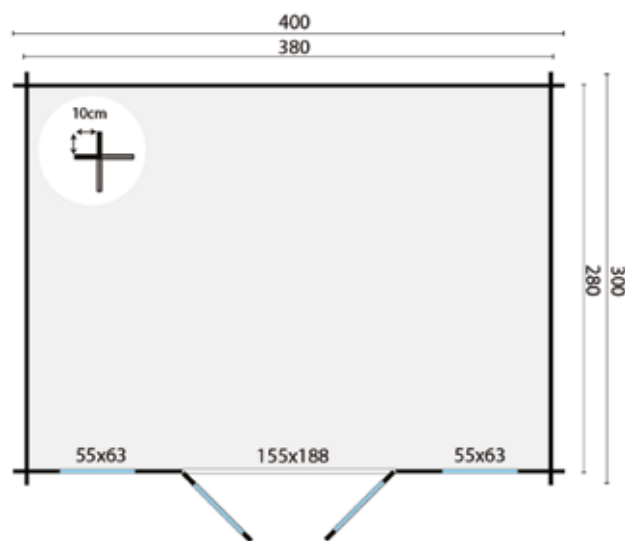

All options can be found from page 399 onwards

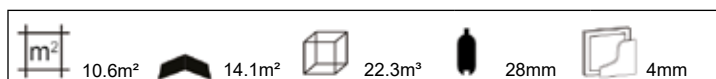

SKYLER - LOG CABIN



Optional roof shingles, straight (24m²)
 Optional roof shingles, beavertail (24m²)
 Optional roof shingles, hexagonal (24m²)

Optional roof tile profile boards (29m²)*
 Optional aquapan

Specifications:

Article no..... 40.0722
 Wood thickness 28mm
 Wood type spruce, untreated
 Dimensions..... 500x320+100cm
 Foundation size 482x302cm
 Ridge height approx. 281cm
 Windows 2 (can be opened)
 Glass single glazing

Supplied with separate bars for windows and doors

* Tip: When fitting roof tile profile boards we recommend that you also order the wide wind stops

The colour of the gutter planks and wind stops may differ somewhat

Optional extra's

Impregnation: Green

Impregnation: Brown, Silver-Grey

Impregnating Liquid in Green, Brown, Silver-Grey or Transparent (3)

Spray-applied base coat: White, Grey, Charcoal, Transparent

Stain (5)

Carefree protect (5)

Starter's set (Nails, air vent & storm anchor set)

Foundation beams, impregnated 300cm (6)

Foundation beams, hardwood 300cm (6)

Foundation beams, synthetic 300cm (6)

Construction girders, hardwood 4.0x20.0x300cm (6)

Hardwood stakes with point 6.0x6.0x75cm (30)

Gutter set plastic 65mm (charcoal)

Gutter set plastic 100mm (charcoal)

Gutter set thermally galvanised 125mm

Gutter plank (impr. Spruce, necessary for fitting a gutter) (3)

Skylight (only with roofing felt and roof shingles)

Roof covering kit (4)

Glazing kit white

Wooden floor 18mm (7)

Wooden floor 18mm impregnated (7)

Wooden floor 26mm (9)

Wooden floor 26mm impregnated (9)

Additional wall layer

* Wide wind stop (impregnated spruce) (8)

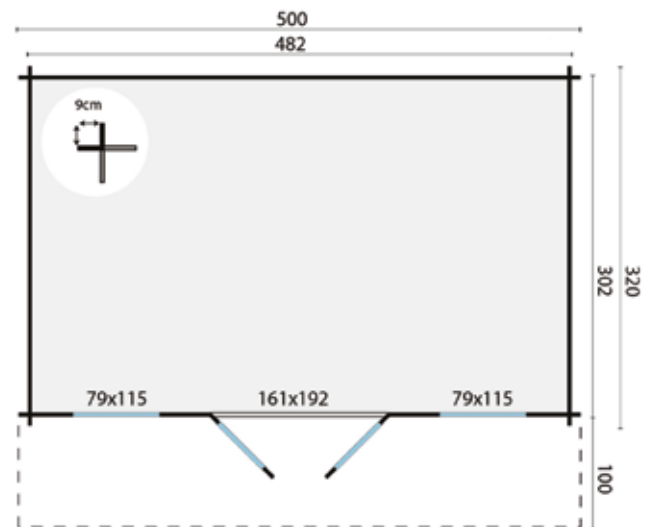

All options can be found from page 399 onwards

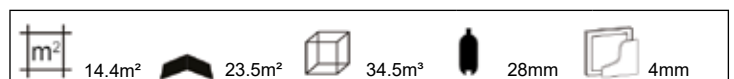

VIGGO - LOG CABIN



Optional roof shingles, straight (33m²)
 Optional roof shingles, beavertail (33m²)
 Optional roof shingles, hexagonal (33m²)

Optional roof tile profile boards (36m²)*
 Optional aquapan

Specifications:

Article no..... 40.0733
 Wood thickness 28mm
 Wood type spruce, untreated
 Dimensions..... 500x380+100cm
 Foundation size 480x360cm
 Ridge height approx. 281cm
 Windows 2 (can be opened)
 Glass single glazing

Supplied with fixed bars for windows and doors

* Tip: When fitting roof tile profile boards we recommend that you also order the wide wind stops

The colour of the gutter planks and wind stops may differ somewhat

Optional extra's

- Impregnation: Green, Brown, Silver-Grey
- Impregnating Liquid in Green, Brown, Silver-Grey or Transparent (3)
- Spray-applied base coat: White, Grey, Charcoal, Transparent
- Stain (6)
- Carefree protect (6)
- Starter's set (Nails, air vent & storm anchor set)
- Foundation beams, impregnated 300cm (7)
- Foundation beams, hardwood 300cm (7)
- Foundation beams, synthetic 300cm (7)
- Construction girders, hardwood 4.0x20.0x300cm (7)
- Hardwood stakes with point 6.0x6.0x75cm (35)
- Gutter set plastic 65mm (charcoal)
- Gutter set plastic 100mm (charcoal)
- Gutter set thermally galvanised 125mm
- Gutter plank (impr. Spruce, necessary for fitting a gutter) (3)
- Skylight (only with roofing felt and roof shingles)
- Roof covering kit (4)
- Glazing kit white
- Wooden floor 18mm (9)
- Wooden floor 18mm impregnated (9)
- Wooden floor 26mm (12)
- Wooden floor 26mm impregnated (12)
- Additional wall layer
- * Wide wind stop (impregnated spruce) (8)

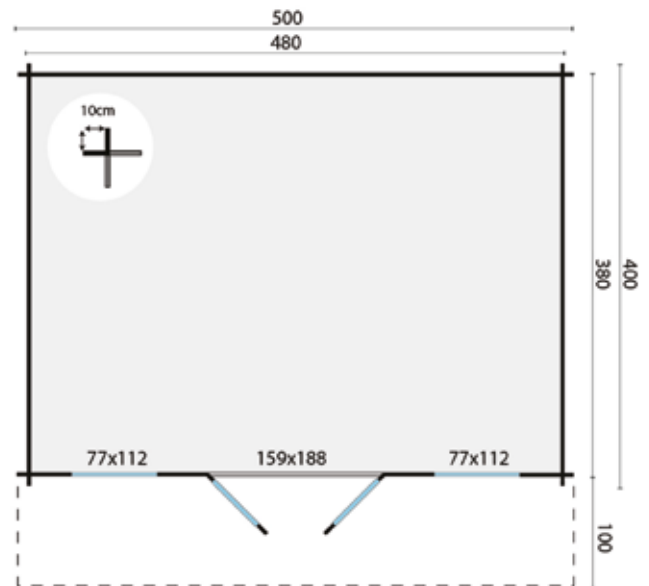

All options can be found from page 399 onwards

18.2m²
 27.2m²
 45.5m³
 28mm
 4mm

SIDE PORCH



Side porch 175 Optional roof shingles, straight (3m²)
 Side porch 175 Optional roof shingles, beavertail (3m²)
 Side porch 175 Optional roof shingles, hexagonal (3m²)

Side porch 275 Optional roof shingles, straight (6m²)
 Side porch 275 Optional roof shingles, beavertail (6m²)
 Side porch 275 Optional roof shingles, hexagonal (6m²)

Specifications:

Article no..... 40.1517
 Dimensions..... 150x175cm
 Wood type spruce, untreated
 Fitting kit..... included

Specifications:

Article no..... 40.1527
 Dimensions..... 150x275cm
 Wood type spruce, untreated
 Fitting kit..... included

Optional extra's

- Impregnation: Green, Brown, Silver-Grey
- Impregnating Liquid in Green, Brown, Silver-Grey or Transparent
- Asphalt nail, galvanised
- Roof board nails
- Stain
- Carefree protect
- Roof covering kit

Optional extra's

- Impregnation: Green, Brown, Silver-Grey
- Impregnating Liquid in Green, Brown, Silver-Grey or Transparent
- Asphalt nail, galvanised
- Roof board nails
- Stain
- Carefree protect
- Roof covering kit

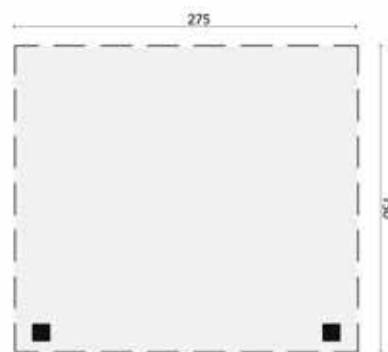
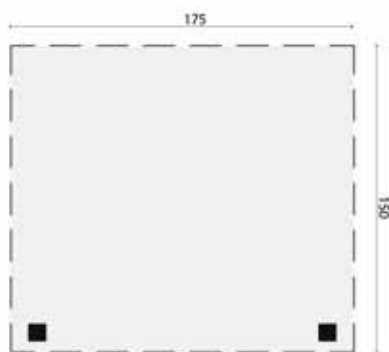

LOG CABIN EXTENSION



Optional roof shingles, straight (6m²)
 Optional roof shingles, beavertail (6m²)
 Optional roof shingles, hexagonal (6m²)

Specifications:

Article no..... 40.1622
 Wood thickness28cm
 Wood type spruce, untreated
 Dimensions.....W160xD220cm
 Foundation sizeW150xD200cm
 Ridge height:185cm
 Fitting kit included
 Can also be constructed in mirror image

Optional extra's

- Impregnation: Green, Brown, Silver-Grey
- Impregnating Liquid in Green, Brown, Silver-Grey or Transparent
- Spray-applied base coat: White, Grey, Charcoal, Transparent Stain (2)
- Carefree protect (2)
- Asphalt nail, galvanised
- Roof board nails
- Foundation beams, impregnated 300cm (2)
- Foundation beams, hardwood 300cm (2)
- Foundation beams, synthetic 300cm (2)
- Construction girders, hardwood 4.0x20.0x300cm (2)
- Hardwood stakes with point 6.0x6.0x75cm (10)
- Gutter set plastic 65mm (charcoal)
- Gutter set plastic 100mm (charcoal)
- Gutter set thermally galvanised 125mm
- Gutter plank (necessary for fitting a gutter)
- Roof covering kit
- Wooden floor 18cm (2)
- Wooden floor 18cm impregnated (2)
- Wooden floor 27cm (2)
- Wooden floor 27cm impregnated (2)
- Additional wall layer

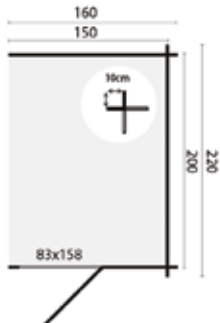

Optional roof shingles, straight (6m²)
 Optional roof shingles, beavertail (6m²)
 Optional roof shingles, hexagonal (6m²)

Specifications:

Article no..... 40.1623
 Wood thickness45cm
 Wood type spruce, untreated
 Dimensions.....W160xD300cm
 Foundation sizeW150xD280cm
 Ridge height185cm
 Fitting kit included
 Can also be constructed in mirror image

Optional extra's

- Impregnation: Green, Brown, Silver-Grey
- Impregnating Liquid in Green, Brown, Silver-Grey or Transparent
- Spray-applied base coat: White, Grey, Charcoal, Transparent Stain (2)
- Carefree protect (2)
- Asphalt nail, galvanised
- Roof board nails
- Foundation beams, impregnated 300cm (2)
- Foundation beams, hardwood 300cm (2)
- Foundation beams, synthetic 300cm (2)
- Construction girders, hardwood 4.0x20.0x300cm (2)
- Hardwood stakes with point 6.0x6.0x75cm (10)
- Gutter set plastic 65mm (charcoal)
- Gutter set plastic 100mm (charcoal)
- Gutter set thermally galvanised 125mm
- Gutter plank (necessary for fitting a gutter)
- Roof covering kit
- Wooden floor 18cm (2)
- Wooden floor 18cm impregnated (2)
- Wooden floor 27cm (3)
- Wooden floor 27cm impregnated (3)
- Additional wall layer

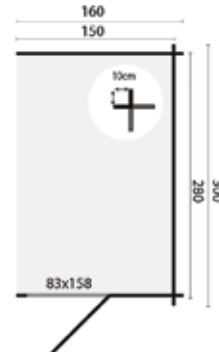

3,0m²
3,8m²
5,4m³
28mm

4,2m²
5,5m²
7,6m³
45mm

JULIA - LOG CABIN

Optional roof shingles, straight (24m²)
 Optional roof shingles, beavertail (24m²)
 Optional roof shingles, hexagonal (24m²)

Optional roof tile profile boards (29m²)*
 Optional aquapan

Specifications:

Article no..... 40.7270
 Wood thickness 40mm
 Wood type spruce, untreated
 Dimensions..... 300x500+68cm
 Foundation size 280x480cm
 Ridge height approx. 236cm
 Windows 1 (can be opened)
 Glass double glazing

Supplied with separate bars for windows and doors

Side window can be placed to the left or to the right

* Tip: When fitting roof tile profile boards we recommend that you also order the wide wind stops

The colour of the gutter planks and wind stops may differ somewhat

Optional extra's

Impregnation: Green, Brown, Silver-Grey
 Impregnating Liquid in Green, Brown, Silver-Grey or Transparent (3)
 Spray-applied base coat: White, Grey, Charcoal, Transparent
 Stain (5)
 Carefree protect (5)
 Starter's set (Nails, air vent & storm anchor set)
 Foundation beams, impregnated 300cm (6)
 Foundation beams, hardwood 300cm (6)
 Foundation beams, synthetic 300cm (6)
 Construction girders, hardwood 4.0x20.0x300cm (6)
 Hardwood stakes with point 6.0x6.0x75cm (30)
 Gutter set plastic 65mm (charcoal)
 Gutter set plastic 100mm (charcoal)
 Gutter set thermally galvanised 125mm
 Gutter plank (impr. Spruce, necessary for fitting a gutter) (3)
 Skylight (only with roofing felt and roof shingles)
 Roof covering kit (4)
 Glazing kit white
 Wooden floor 18mm (7)
 Wooden floor 18mm impregnated (7)
 Wooden floor 26mm (10)
 Wooden floor 26mm impregnated (10)
 Additional wall layer
 * Wide wind stop (impregnated spruce) (4)

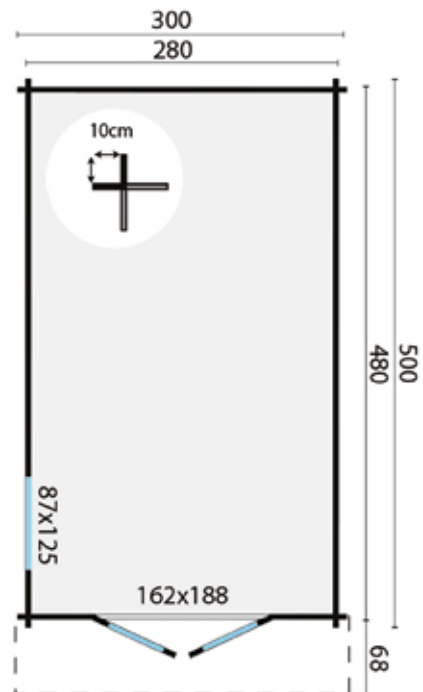

All options can be found from page 399 onwards

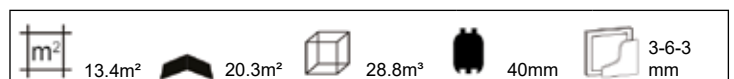

RIHO - LOG CABIN



Optional roofing felt (20m²)
 Optional roof shingles, straight (18m²)
 Optional roof shingles, beaver tail (18m²)

Optional roof shingles, hexagonal (18m²)
 Optional roof tile profile boards (19m²)*
 Optional aquapan

Specifications:

Article no..... 40.0778
 Wood thickness 40mm
 Wood type spruce, untreated
 Dimensions..... 320x320+120cm
 Foundation size 300x300cm
 Ridge height approx. 245cm
 Windows 2 (can be opened)
 Glass single glazing

Supplied with separate bars for windows and doors

Door and windows can be placed to the left or to the right

* Tip: When fitting roof tile profile boards we recommend that you also order the wide wind stops

The colour of the gutter planks and wind stops may differ somewhat

Optional extra's

- Impregnation: Green, Brown, Silver-Grey
- Impregnating Liquid in Green, Brown, Silver-Grey or Transparent (2)
- Spray-applied base coat: White, Grey, Charcoal, Transparent
- Stain (4)
- Carefree protect (4)
- Starter's set (Nails, air vent & storm anchor set)
- Foundation beams, impregnated 300cm (5)
- Foundation beams, hardwood 300cm (5)
- Foundation beams, synthetic 300cm (5)
- Construction girders, hardwood 4.0x20.0x300cm (5)
- Hardwood stakes with point 6.0x6.0x75cm (25)
- Gutter set plastic 65mm (charcoal)
- Gutter set plastic 100mm (charcoal)
- Gutter set thermally galvanised 125mm
- Gutter plank (impr. Spruce, necessary for fitting a gutter) (3)
- Skylight (only with roofing felt and roof shingles)
- Roof covering kit (4)
- Glazing kit white
- Wooden floor 18mm (5)
- Wooden floor 18mm impregnated (5)
- Wooden floor 26mm (6)
- Wooden floor 26mm impregnated (6)
- Additional wall layer
- * Wide wind stop (impregnated spruce) (4)

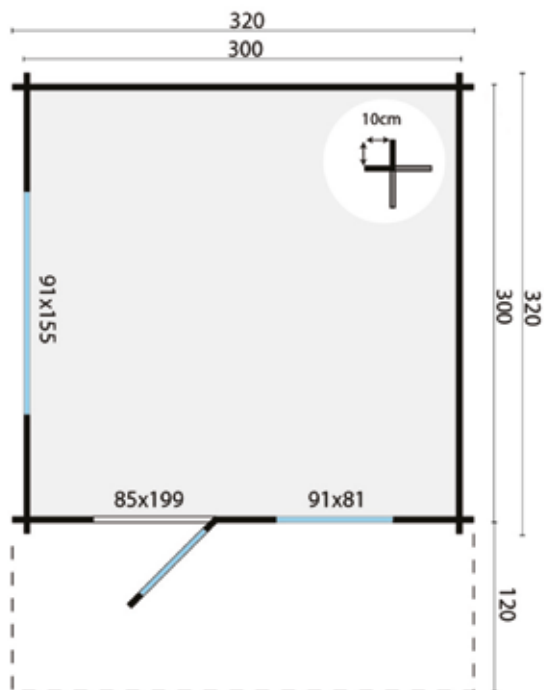

All options can be found from page 399 onwards

m² 9.0m²
 15.5m²
 20.0m³
 40mm
 4mm

INGLUND - LOG CABIN



Optional roofing felt (26.5m²)
 Optional roof shingles, straight (24m²)
 Optional roof shingles, beavertail (24m²)

Optional roof shingles, hexagonal (24m²)
 Optional roof tile profile boards (29m²)*
 Optional aquapan

Specifications:

Article no..... 40.0768
 Wood thickness 44mm
 Wood type spruce, untreated
 Dimensions..... 380x320+150cm
 Foundation size 362x302cm
 Ridge height approx. 263cm
 Windows 2 (fixed), 1 (can be opened)
 Glass single glazing

Supplied with separate bars for windows and doors

Side window can be placed to the left or to the right

* Tip: When fitting roof tile profile boards we recommend that you also order the wide wind stops

The colour of the gutter planks and wind stops may differ somewhat

Optional extra's

Impregnation: Green, Brown, Silver-Grey

Impregnating Liquid in Green, Brown, Silver-Grey or Transparent (3)

Spray-applied base coat: White, Grey, Charcoal, Transparent

Stain (5)

Carefree protect (5)

Starter's set (Nails, air vent & storm anchor set)

Foundation beams, impregnated 300cm (5)

Foundation beams, hardwood 300cm (5)

Foundation beams, synthetic 300cm (5)

Construction girders, hardwood 4.0x20.0x300cm (5)

Hardwood stakes with point 6.0x6.0x75cm (25)

Gutter set plastic 65mm (charcoal)

Gutter set plastic 100mm (charcoal)

Gutter set thermally galvanised 125mm

Gutter plank (impr. Spruce, necessary for fitting a gutter) (3)

Skylight (only with roofing felt and roof shingles)

Roof covering kit (4)

Glazing kit white

Wooden floor 18mm (5)

Wooden floor 18mm impregnated (5)

Wooden floor 26mm (7)

Wooden floor 26mm impregnated (7)

Additional wall layer

* Wide wind stop (impregnated spruce) (8)

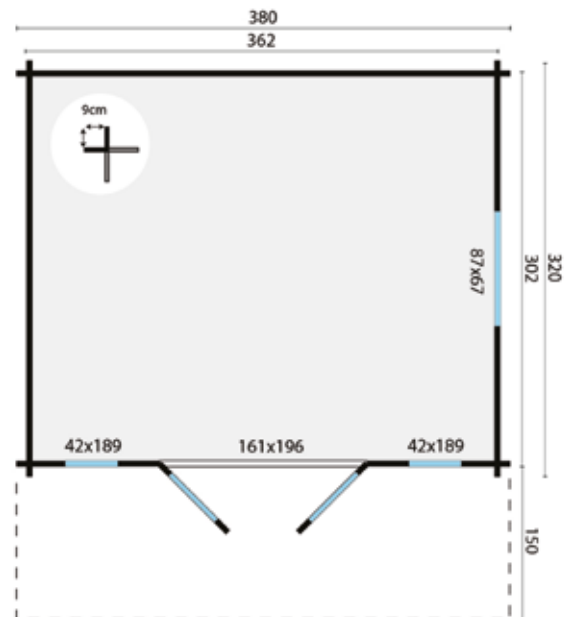

All options can be found from page 399 onwards

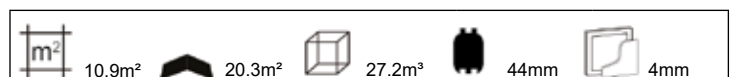

SANSTROV - LOG CABIN



Optional roof shingles, straight (30m²)
 Optional roof shingles, beavertail (30m²)
 Optional roof shingles, hexagonal (30m²)

Optional roof tile profile boards (34m²)*
 Optional aquapan

Specifications:

Article no..... 40.0769
 Wood thickness 44mm
 Wood type spruce, untreated
 Dimensions..... 380x320+270cm
 Foundation size 360x570cm
 Ridge height approx. 270cm
 Windows 2 (fixed), 1 (can be opened)
 Glass single glazing

Supplied with fixed bars for windows and doors
 Side window can be placed to the left or to the right
 * Tip: When fitting roof tile profile boards we recommend that you also order the wide wind stops
 The colour of the gutter planks and wind stops may differ somewhat

Optional extra's

- Impregnation: Green, Brown, Silver-Grey
- Impregnating Liquid in Green, Brown, Silver-Grey or Transparent (3)
- Spray-applied base coat: White, Grey, Charcoal, Transparent
- Stain (6)
- Carefree protect (6)
- Starter's set (Nails, air vent & storm anchor set)
- Foundation beams, impregnated 300cm (8)
- Foundation beams, hardwood 300cm (8)
- Foundation beams, synthetic 300cm (8)
- Construction girders, hardwood 4.0x20.0x300cm (8)
- Hardwood stakes with point 6.0x6.0x75cm (40)
- Gutter set plastic 65mm (charcoal)
- Gutter set plastic 100mm (charcoal)
- Gutter set thermally galvanised 125mm
- Gutter plank (impr. Spruce, necessary for fitting a gutter) (4)
- Skylight (only with roofing felt and roof shingles)
- Roof covering kit (5)
- Glazing kit white
- Wooden floor 18mm (5)
- Wooden floor 18mm impregnated (5)
- Wooden floor 26mm (7)
- Wooden floor 26mm impregnated (7)
- Additional wall layer
- * Wide wind stop (impregnated spruce) (8)

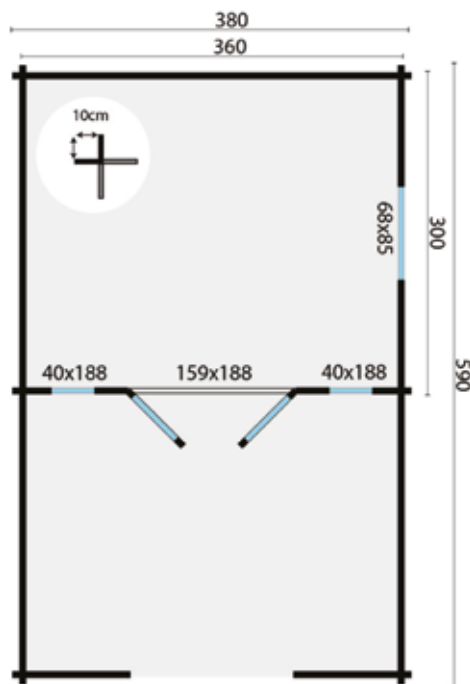

All options can be found from page 399 onwards
 Wooden floor under the Porch, see page 64 and 404

	10.8m ² 9.7m ²		24.8m ²		26.0m ³		44mm		4mm
--	---	--	--------------------	--	--------------------	--	------	--	-----

ULRIK - LOG CABIN

Optional roofing felt (26.5m²)
 Optional roof shingles, straight (24m²)
 Optional roof shingles, beavertail (24m²)

Optional roof shingles, hexagonal (24m²)
 Optional roof tile profile boards (23m²)*
 Optional aquapan

Specifications:

Article no..... 40.0880
 Wood thickness 44mm
 Wood type spruce, untreated
 Dimensions..... 380x380+70cm
 Foundation size 360x360cm
 Ridge height approx. 260cm
 Windows 1 (can be opened)
 Glass double glazing

Supplied with separate bars for windows and doors

Doors and windows can be placed to the left or to the right.

* Tip: When fitting roof tile profile boards we recommend that you also order the wide wind stops

The colour of the gutter planks and wind stops may differ somewhat

Optional extra's

Impregnation: Green, Brown, Silver-Grey
 Impregnating Liquid in Green, Brown, Silver-Grey or Transparent (3)
 Spray-applied base coat: White, Grey, Charcoal, Transparent
 Stain (5)
 Carefree protect (5)
 Starter's set (Nails, air vent & storm anchor set)
 Foundation beams, impregnated 300cm (5)
 Foundation beams, hardwood 300cm (5)
 Foundation beams, synthetic 300cm (5)
 Construction girders, hardwood 4.0x20.0x300cm (5)
 Hardwood stakes with point 6.0x6.0x75cm (25)
 Gutter set plastic 65mm (charcoal)
 Gutter set plastic 100mm (charcoal)
 Gutter set thermally galvanised 125mm
 Gutter plank (impr. Spruce, necessary for fitting a gutter) (3)
 Skylight (only with roofing felt and roof shingles)
 Roof covering kit (4)
 Glazing kit white
 Wooden floor 18mm (6)
 Wooden floor 18mm impregnated (6)
 Wooden floor 26mm (9)
 Wooden floor 26mm impregnated (9)
 Additional wall layer
 * Wide wind stop (impregnated spruce) (8)

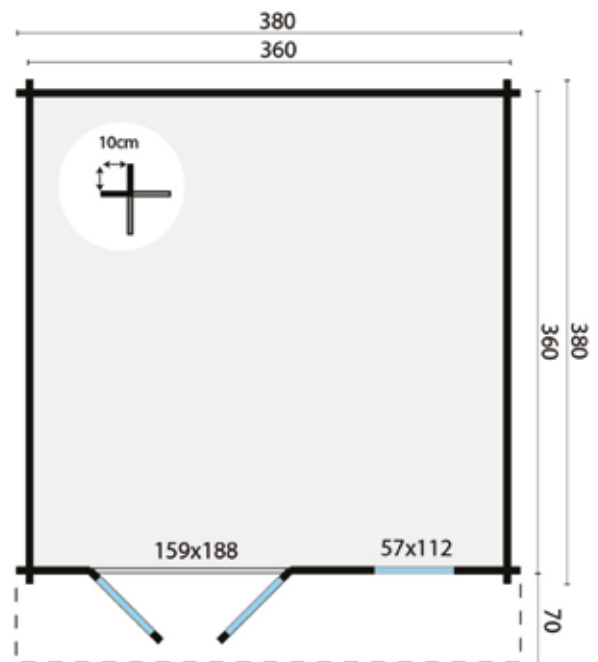

All options can be found from page 399 onwards



SÖREN - LOG CABIN



Optional roofing felt (32.5m²)
 Optional roof shingles, straight (27m²)
 Optional roof shingles, beavertail (27m²)

Optional roof shingles, hexagonal (27m²)
 Optional roof tile profile boards (28m²)*
 Optional aquapan

Specifications:

Article no..... 40.0767
 Wood thickness 44mm
 Wood type spruce, untreated
 Dimensions..... 380x380+150cm
 Foundation size 360x360cm
 Ridge height approx. 277cm
 Windows 2 (fixed), 1 (can be opened)
 Glass single glazing

Supplied with separate bars for windows and doors
 Side window can be placed to the left or to the right
 * Tip: When fitting roof tile profile boards we recommend that you also order the wide wind stops
 The colour of the gutter planks and wind stops may differ somewhat

Optional extra's

- Impregnation: Green
- Impregnation: Brown, Silver-Grey
- Impregnating Liquid in Green, Brown, Silver-Grey or Transparent (3)
- Spray-applied base coat: White, Grey, Charcoal, Transparent
- Stain (5)
- Carefree protect (5)
- Starter's set (Nails, air vent & storm anchor set)
- Foundation beams, impregnated 300cm (5)
- Foundation beams, hardwood 300cm (5)
- Foundation beams, synthetic 300cm (5)
- Construction girders, hardwood 4.0x20.0x300cm (5)
- Hardwood stakes with point 6.0x6.0x75cm (25)
- Gutter set plastic 65mm (charcoal)
- Gutter set plastic 100mm (charcoal)
- Gutter set thermally galvanised 125mm
- Gutter plank (impr. Spruce, necessary for fitting a gutter) (3)
- Skylight (only with roofing felt and roof shingles)
- Roof covering kit (4)
- Glazing kit white
- Wooden floor 18mm (6)
- Wooden floor 18mm impregnated (6)
- Wooden floor 26mm (9)
- Wooden floor 26mm impregnated (9)
- Additional wall layer
- * Wide wind stop (impregnated spruce) (8)

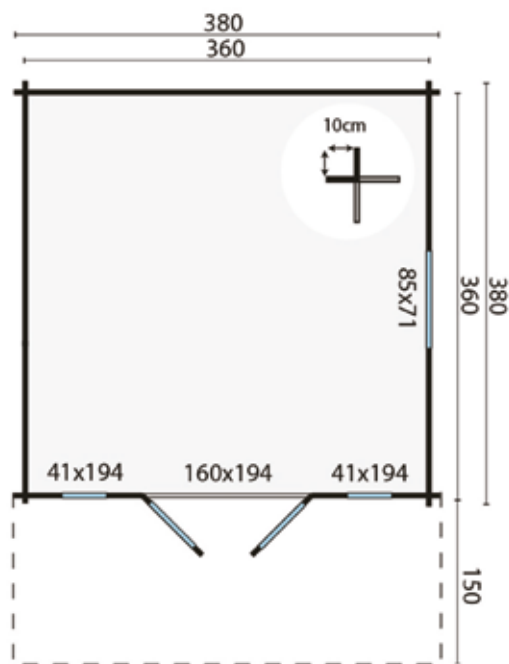

All options can be found from page 399 onwards

m² 13.0m²
▲ 21.2m²
◻ 28.6m³
■ 44mm
 □ 4mm

HEDVIG - LOG CABIN

Optional roof shingles, straight (30m²)
 Optional roof shingles, beavertail (30m²)
 Optional roof shingles, hexagonal (30m²)

Optional roof tile profile boards (34m²)*
 Optional aquapan

Specifications:

Article no..... 40.0880
 Wood thickness 44mm
 Wood type spruce, untreated
 Dimensions..... 380x380+70cm
 Foundation size 360x360cm
 Ridge height approx. 270cm
 Windows 1 (can be opened)
 Glass single glazing

Supplied with fixed bars for windows and doors

Side window can be placed to the left or to the right

* Tip: When fitting roof tile profile boards we recommend that you also order the wide wind stops

The colour of the gutter planks and wind stops may differ somewhat

Optional extra's

Impregnation: Green, Brown, Silver-Grey

Impregnating Liquid in Green, Brown, Silver-Grey or Transparent (3)

Spray-applied base coat: White, Grey, Charcoal, Transparent

Stain (5)

Carefree protect (5)

Starter's set (Nails, air vent & storm anchor set)

Foundation beams, impregnated 300cm (8)

Foundation beams, hardwood 300cm (8)

Foundation beams, synthetic 300cm (8)

Construction girders, hardwood 4.0x20.0x300cm (8)

Hardwood stakes with point 6.0x6.0x75cm (40)

Gutter set plastic 100mm (charcoal)

Gutter set thermally galvanised 125mm

Gutter plank (impr. Spruce, necessary for fitting a gutter) (3)

Skylight (only with roofing felt and roof shingles)

Roof covering kit (5)

Glazing kit white

Wooden floor 18mm (6)

Wooden floor 18mm impregnated (6)

Wooden floor 26mm (8)

Wooden floor 26mm impregnated (8)

Additional wall layer

* Wide wind stop (impregnated spruce) (8)

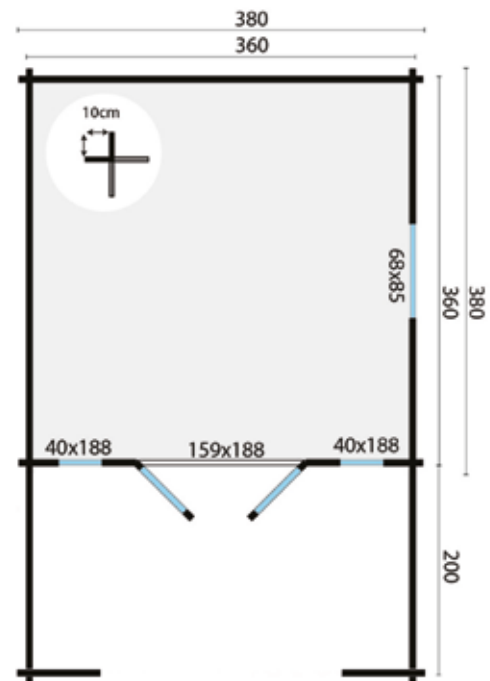

All options can be found from page 399 onwards
 Wooden floor under the Porch, see page 64 and 404

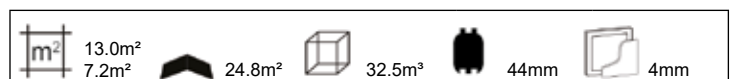

LOG CABIN DYRE

Optional roofing felt (26.5m²)
 Optional roof shingles, straight (18m²)
 Optional roof shingles, beaver tail (18m²)

Optional roof shingles, hexagonal (18m²)
 Optional roof tile profile boards (19m²)*
 Optional aquapan

Specifications:

Article no..... 40.7220
 Wood thickness 40mm
 Wood type spruce, untreated
 Dimensions..... 400x300+40cm
 Foundation size 382x282cm
 Ridge height approx. 236cm
 Windows 1 (can be opened)
 Glass double glazing

Supplied with separate bars for windows and doors

Side window can be placed to the left or to the right

* Tip: When fitting roof tile profile boards we recommend that you also order the wide wind stops

The colour of the gutter planks and wind stops may differ somewhat

Optional extra's

Impregnation: Green, Brown, Silver-Grey

Impregnating Liquid in Green, Brown, Silver-Grey or Transparent (3)

Spray-applied base coat: White, Grey, Charcoal, Transparent

Stain (5)

Carefree protect (5)

Starter's set (Nails, air vent & storm anchor set)

Foundation beams, impregnated 300cm (5)

Foundation beams, hardwood 300cm (5)

Foundation beams, synthetic 300cm (5)

Construction girders, hardwood 4.0x20.0x300cm (5)

Hardwood stakes with point 6.0x6.0x75cm (25)

Gutter set plastic 100mm (charcoal)

Gutter set thermally galvanised 125mm

Gutter plank (impr. Spruce, necessary for fitting a gutter) (2)

Skylight (only with roofing felt and roof shingles)

Roof covering kit (4)

Glazing kit white

Wooden floor 18mm (6)

Wooden floor 18mm impregnated (6)

Wooden floor 26mm (8)

Wooden floor 26mm impregnated (8)

Additional wall layer

* Wide wind stop (impregnated spruce) (8)

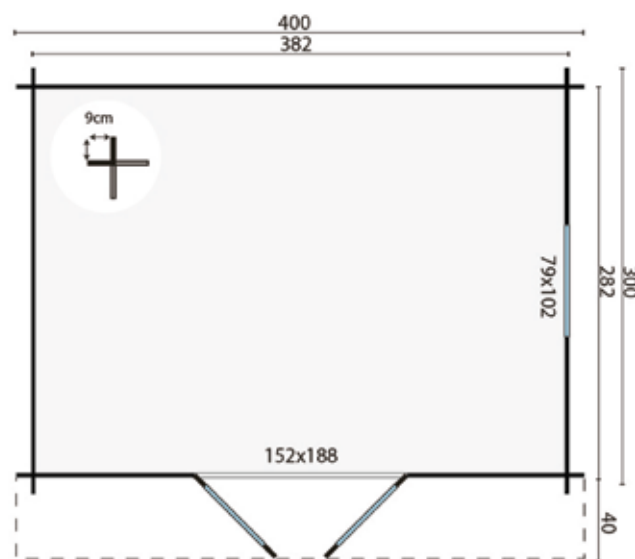

All options can be found from page 399 onwards

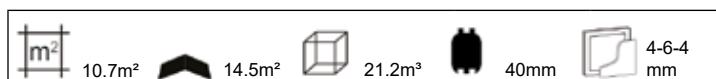

GUNDA - LOG CABIN

Optional roofing felt (26.5m²)
 Optional roof shingles, straight (24m²)
 Optional roof shingles, beaver tail (24m²)

Optional roof shingles, hexagonal (24m²)
 Optional roof tile profile boards (23m²)*
 Optional aquapan

Specifications:

Article no..... 40.7221
 Wood thickness 40mm
 Wood type spruce, untreated
 Dimensions..... 400x400+40cm
 Foundation size 382x382cm
 Ridge height approx. 236cm
 Windows 1 (can be opened)
 Glass double glazing

Supplied with separate bars for windows and doors
 Side window can be placed to the left or to the right

* Tip: When fitting roof tile profile boards we recommend that you also order the wide wind stops

The colour of the gutter planks and wind stops may differ somewhat

Optional extra's

Impregnation: Green, Brown, Silver-Grey
 Impregnating Liquid in Green, Brown, Silver-Grey or Transparent (3)
 Spray-applied base coat: White, Grey, Charcoal, Transparent
 Stain (5)
 Carefree protect (5)
 Starter's set (Nails, air vent & storm anchor set)
 Foundation beams, impregnated 300cm (6)
 Foundation beams, hardwood 300cm (6)
 Foundation beams, synthetic 300cm (6)
 Construction girders, hardwood 4.0x20.0x300cm (6)
 Hardwood stakes with point 6.0x6.0x75cm (30)
 Gutter set plastic 100mm (charcoal)
 Gutter set thermally galvanised 125mm
 Gutter plank (impr. Spruce, necessary for fitting a gutter) (3)
 Skylight (only with roofing felt and roof shingles)
 Roof covering kit (4)
 Glazing kit white
 Wooden floor 18mm (7)
 Wooden floor 18mm impregnated (7)
 Wooden floor 26mm (9)
 Wooden floor 26mm impregnated (9)
 Additional wall layer
 * Wide wind stop (impregnated spruce) (8)

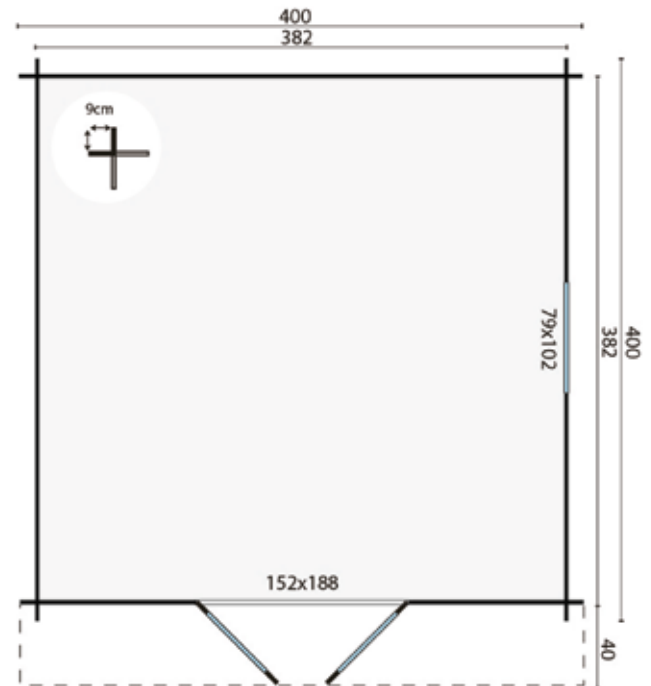

All options can be found from page 399 onwards

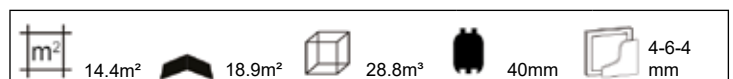

INGE - LOG CABIN



Optional roofing felt (30m²)
 Optional roof shingles, straight (30m²)
 Optional roof shingles, beavertail (30m²)

Optional roof shingles, hexagonal (30m²)
 Optional roof tile profile boards (34m²)*
 Optional aquapan

Specifications:

Article no..... 40.0620
 Wood thickness 44mm
 Wood type spruce, untreated
 Dimensions..... 420x420+120cm
 Foundation size 400x400cm
 Ridge height approx. 247cm
 Windows 2 (can be opened)
 Glass single glazing

Supplied with separate bars for windows and doors

Doors and windows can be placed to the left or to the right.

When using a gutter an extra wall layer is necessary

* Tip: When fitting roof tile profile boards we recommend that you also order the wide wind stops

The colour of the gutter planks and wind stops may differ somewhat

Optional extra's

- Impregnation: Green, Brown, Silver-Grey
- Impregnating Liquid in Green, Brown, Silver-Grey or Transparent (3)
- Spray-applied base coat: White, Grey, Charcoal, Transparent
- Stain (6)
- Carefree protect (6)
- Starter's set (Nails, air vent & storm anchor set)
- Foundation beams, impregnated 300cm (6)
- Foundation beams, hardwood 300cm (6)
- Foundation beams, synthetic 300cm (6)
- Construction girders, hardwood 4.0x20.0x300cm (6)
- Hardwood stakes with point 6.0x6.0x75cm (30)
- Gutter set plastic 65mm (charcoal)
- Gutter set plastic 100mm (charcoal)
- Gutter set thermally galvanised 125mm
- Gutter plank (impr. Spruce, necessary for fitting a gutter) (3)
- Skylight (only with roofing felt and roof shingles)
- Roof covering kit (5)
- Glazing kit white
- Wooden floor 18mm (8)
- Wooden floor 18mm impregnated (8)
- Wooden floor 26mm (10)
- Wooden floor 26mm impregnated (10)
- Additional wall layer
- * Wide wind stop (impregnated spruce) (8)

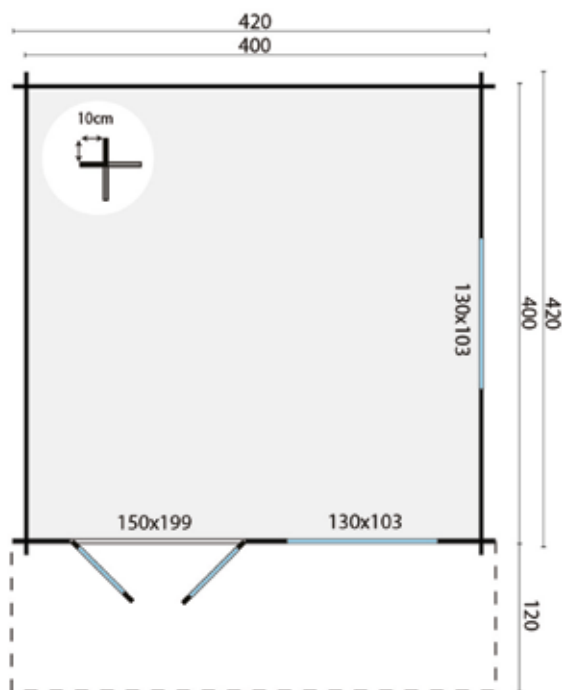

All options can be found from page 399 onwards

16.0m²
24.4m²
36.0m³
44mm
4mm

LAULA - LOG CABIN



Optional roof shingles, straight (30m²)
 Optional roof shingles, beavertail (30m²)
 Optional roof shingles, hexagonal (30m²)

Optional roof tile profile boards (34m²)*
 Optional aquapan

Specifications:

Article no..... 40.0783
 Wood thickness 44mm
 Wood type spruce, untreated
 Dimensions..... 430x430+100cm
 Foundation size 412x412cm
 Ridge height approx. 250cm
 Windows 2 (fixed), 1 (can be opened)
 Glass double glazing

Supplied with separate bars for windows and doors

Side window can be placed to the left or to the right

* Tip: When fitting roof tile profile boards we recommend that you also order the wide wind stops

The colour of the gutter planks and wind stops may differ somewhat

Optional extra's

Impregnation: Green, Brown, Silver-Grey
 Impregnating Liquid in Green, Brown, Silver-Grey or Transparent (3)
 Spray-applied base coat: White, Grey, Charcoal, Transparent
 Stain (5)
 Carefree protect (5)
 Starter's set (Nails, air vent & storm anchor set)
 Foundation beams, impregnated 300cm (6)
 Foundation beams, hardwood 300cm (6)
 Foundation beams, synthetic 300cm (6)
 Construction girders, hardwood 4.0x20.0x300cm (6)
 Hardwood stakes with point 6.0x6.0x75cm (30)
 Gutter set plastic 65mm (charcoal)
 Gutter set plastic 100mm (charcoal)
 Gutter set thermally galvanised 125mm
 Gutter plank (impr. Spruce, necessary for fitting a gutter) (3)
 Skylight (only with roofing felt and roof shingles)
 Roof covering kit (4)
 Glazing kit white
 Wooden floor 18mm (9)
 Wooden floor 18mm impregnated (9)
 Wooden floor 26mm (11)
 Wooden floor 26mm impregnated (11)
 Additional wall layer
 * Wide wind stop (impregnated spruce) (8)

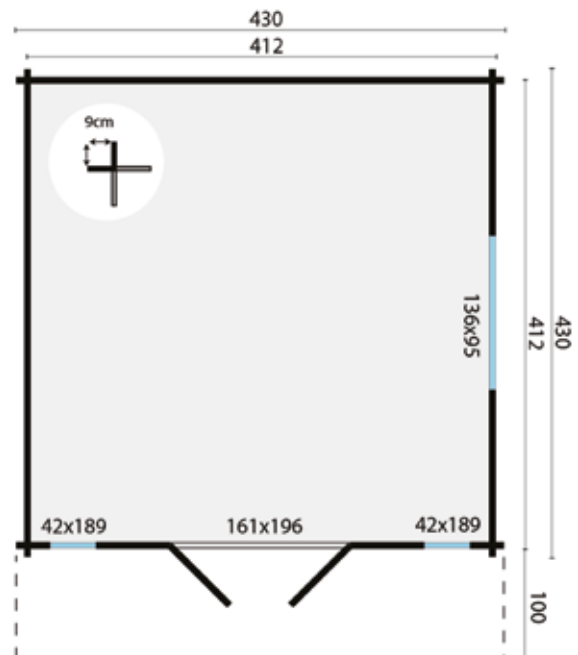

All options can be found from page 399 onwards



FRODO - LOG CABIN



Optional roof shingles, straight (36m²)
 Optional roof shingles, beavertail (36m²)
 Optional roof shingles, hexagonal (36m²)

Optional roof tile profile boards (38m²)*
 Optional aquapan

Specifications:

Article no..... 40.0784
 Wood thickness 44mm
 Wood type spruce, untreated
 Dimensions..... 430x430+220cm
 Foundation size 410x630cm
 Ridge height approx. 258cm
 Windows 2 (fixed), 1 (can be opened)
 Glass single glazing

Supplied with fixed bars for windows and doors
 Side window can be placed to the left or to the right
 * Tip: When fitting roof tile profile boards we recommend that you also order the wide wind stops
 The colour of the gutter planks and wind stops may differ somewhat

Optional extra's

- Impregnation: Green, Brown, Silver-Grey
- Impregnating Liquid in Green, Brown, Silver-Grey or Transparent (3)
- Spray-applied base coat: White, Grey, Charcoal, Transparent
- Stain (6)
- Carefree protect (6)
- Starter's set (Nails, air vent & storm anchor set)
- Foundation beams, impregnated 300cm (8)
- Foundation beams, hardwood 300cm (8)
- Foundation beams, synthetic 300cm (8)
- Construction girders, hardwood 4.0x20.0x300cm (8)
- Hardwood stakes with point 6.0x6.0x75cm (40)
- Gutter set plastic 100mm (charcoal)
- Gutter set thermally galvanised 125mm
- Gutter plank (impr. Spruce, necessary for fitting a gutter) (4)
- Skylight (only with roofing felt and roof shingles)
- Roof covering kit (5)
- Glazing kit white
- Wooden floor 18mm (9)
- Wooden floor 18mm impregnated (9)
- Wooden floor 26mm (11)
- Wooden floor 26mm impregnated (11)
- Additional wall layer
- * Wide wind stop (impregnated spruce) (8)



All options can be found from page 399 onwards
 Wooden floor under the Porch, see page 64 and 404

	16.8m ²		30.4m ²		42.0m ³		44mm		4mm
	9.0m ²								

HEINO - LOG CABIN



Optional roof shingles, straight (33m²)
 Optional roof shingles, beavertail (33m²)
 Optional roof shingles, hexagonal (33m²)

Optional roof tile profile boards (38m²)*
 Optional aquapan

Specifications:

Article no..... 40.0779
 Wood thickness 44mm
 Wood type spruce, untreated
 Dimensions..... 450x380+200cm
 Foundation size 430x560cm
 Ridge height approx. 275cm
 Windows 2 (fixed), 1 (can be opened)
 Glass single glazing

Supplied with separate bars for windows and doors
 Side window can be placed to the left or to the right

* Tip: When fitting roof tile profile boards we recommend that you also order the wide wind stops

The colour of the gutter planks and wind stops may differ somewhat

Optional extra's

Impregnation: Green, Brown, Silver-Grey
 Impregnating Liquid in Green, Brown, Silver-Grey or Transparent (3)
 Spray-applied base coat: White, Grey, Charcoal, Transparent
 Stain (6)
 Carefree protect (6)
 Starter's set (Nails, air vent & storm anchor set)
 Foundation beams, impregnated 300cm (8)
 Foundation beams, hardwood 300cm (8)
 Foundation beams, synthetic 300cm (8)
 Construction girders, hardwood 4.0x20.0x300cm (8)
 Hardwood stakes with point 6.0x6.0x75cm (40)
 Gutter set plastic 100mm (charcoal)
 Gutter set thermally galvanised 125mm
 Gutter plank (impr. Spruce, necessary for fitting a gutter) (4)
 Skylight (only with roofing felt and roof shingles)
 Roof covering kit (5)
 Glazing kit white
 Wooden floor 18mm (8)
 Wooden floor 18mm impregnated (8)
 Wooden floor 26mm (10)
 Wooden floor 26mm impregnated (10)
 Additional wall layer
 * Wide wind stop (impregnated spruce) (8)

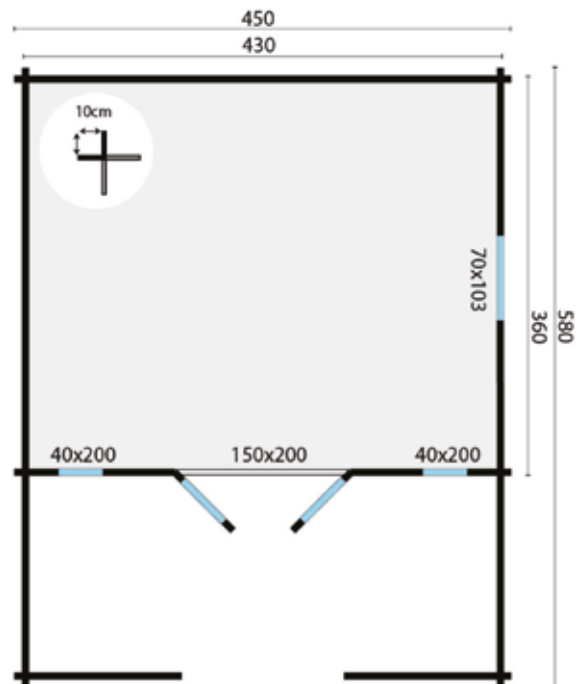

All options can be found from page 399 onwards
 Wooden floor under the Porch, see page 64 and 404

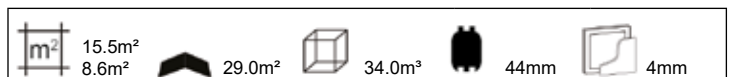

GUSTAV - LOG CABIN



Optional roof shingles, straight (30m²)
 Optional roof shingles, beavertail (30m²)
 Optional roof shingles, hexagonal (30m²)

Optional roof tile profile boards (34m²)*
 Optional aquapan

Specifications:

Article no..... 40.0760
 Wood thickness 44mm
 Wood type spruce, untreated
 Dimensions..... 500x380+120cm
 Foundation size 480x360cm
 Ridge height approx. 277cm
 Windows 2 (fixed), 1 (can be opened)
 Glass single glazing

Supplied with separate bars for windows and doors
 Side window can be placed to the left or to the right
 * Tip: When fitting roof tile profile boards we recommend that you also order the wide wind stops
 The colour of the gutter planks and wind stops may differ somewhat

Optional extra's

- Impregnation: Green, Brown, Silver-Grey
- Impregnating Liquid in Green, Brown, Silver-Grey or Transparent (3)
- Spray-applied base coat: White, Grey, Charcoal, Transparent
- Stain (6)
- Carefree protect (6)
- Starter's set (Nails, air vent & storm anchor set)
- Foundation beams, impregnated 300cm (6)
- Foundation beams, hardwood 300cm (6)
- Foundation beams, synthetic 300cm (6)
- Construction girders, hardwood 4.0x20.0x300cm (6)
- Hardwood stakes with point 6.0x6.0x75cm (30)
- Gutter set plastic 100mm (charcoal)
- Gutter set thermally galvanised 125mm
- Gutter plank (impr. Spruce, necessary for fitting a gutter) (3)
- Skylight (only with roofing felt and roof shingles)
- Roof covering kit (4)
- Glazing kit white
- Wooden floor 18mm (8)
- Wooden floor 18mm impregnated (8)
- Wooden floor 26mm (12)
- Wooden floor 26mm impregnated (12)
- Additional wall layer
- * Wide wind stop (impregnated spruce) (8)

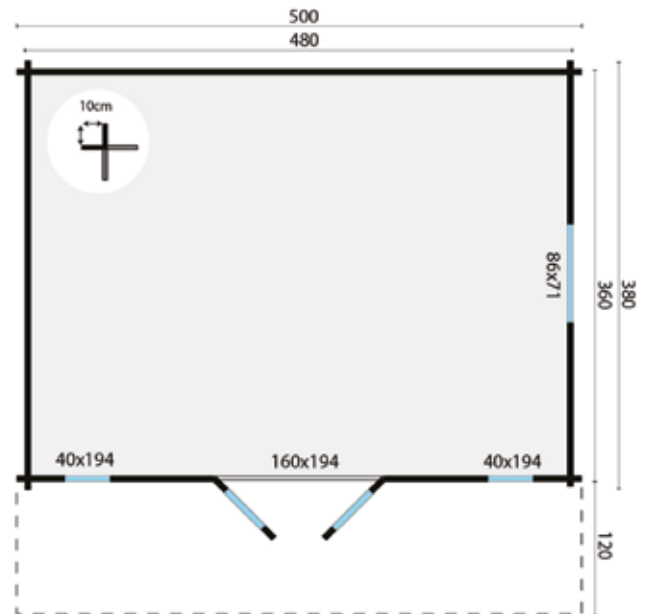

All options can be found from page 399 onwards

m² 17.3m²
27.0m²
37.0m³
44mm
4mm

HENDRICK - LOG CABIN

Optional roofing felt (45.5m²)
 Optional roof shingles, straight (33m²)
 Optional roof shingles, beaver tail (33m²)

Optional roof shingles, hexagonal (33m²)
 Optional roof tile profile boards (39m²)*
 Optional aquapan

Specifications:

Article no..... 40.0787
 Wood thickness 44mm
 Wood type spruce, untreated
 Dimensions..... 500x500+70cm
 Foundation size 480x480cm
 Ridge height approx. 250cm
 Windows 1 (can be opened)
 Glass double glazing

Supplied with separate bars for windows and doors
 rs and windows can be placed to the left or to the right.

* Tip: When fitting roof tile profile boards we recommend that you also order the wide wind stops

The colour of the gutter planks and wind stops may differ somewhat

Optional extra's

Impregnation: Green, Brown, Silver-Grey
 Impregnating Liquid in Green, Brown, Silver-Grey or Transparent (3)
 Spray-applied base coat: White, Grey, Charcoal, Transparent
 Stain (6)
 Carefree protect (6)
 Starter's set (Nails, air vent & storm anchor set)
 Foundation beams, impregnated 300cm (7)
 Foundation beams, hardwood 300cm (7)
 Foundation beams, synthetic 300cm (7)
 Construction girders, hardwood 4.0x20.0x300cm (7)
 Hardwood stakes with point 6.0x6.0x75cm (35)
 Gutter set plastic 100mm (charcoal)
 Gutter set thermally galvanised 125mm
 Gutter plank (impr. Spruce, necessary for fitting a gutter) (4)
 Skylight (only with roofing felt and roof shingles)
 Roof covering kit (5)
 Glazing kit white
 Wooden floor 18mm (11)
 Wooden floor 18mm impregnated (11)
 Wooden floor 26mm (14)
 Wooden floor 26mm impregnated (14)
 Additional wall layer
 * Wide wind stop (impregnated spruce) (8)

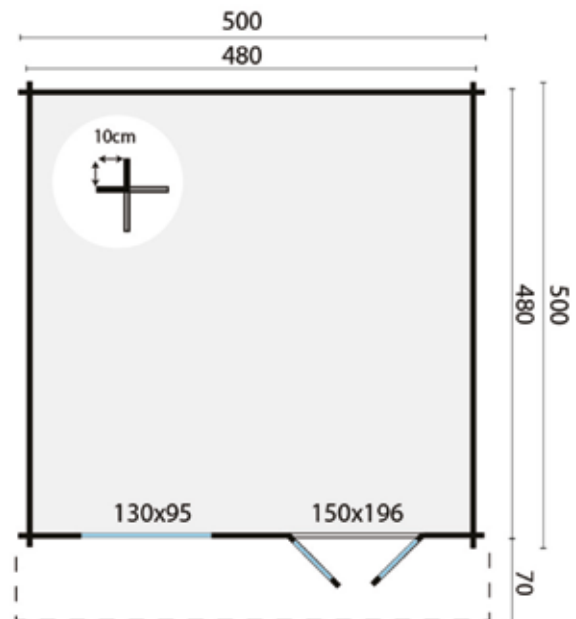

All options can be found from page 399 onwards



EMIEL - LOG CABIN

Optional roof shingles, straight (42m²)
 Optional roof shingles, beavertail (42m²)
 Optional roof shingles, hexagonal (42m²)

Optional roof tile profile boards (41m²)*
 Optional aquapan

Specifications:

Article no..... 40.0765
 Wood thickness 44mm
 Wood type spruce, untreated
 Dimensions..... 500x500+170cm
 Foundation size 480x480cm
 Ridge height approx. 290cm
 Windows 2 (fixed), 1 (can be opened)
 Glass single glazing

Supplied with separate bars for windows and doors

Side window can be placed to the left or to the right

* Tip: When fitting roof tile profile boards we recommend that you also order the wide wind stops

The colour of the gutter planks and wind stops may differ somewhat

Optional extra's

Impregnation: Green, Brown, Silver-Grey
 Impregnating Liquid in Green, Brown, Silver-Grey or Transparent (4)
 Spray-applied base coat: White, Grey, Charcoal, Transparent Stain (7)
 Carefree protect (7)
 Starter's set (Nails, air vent & storm anchor set)
 Foundation beams, impregnated 300cm (7)
 Foundation beams, hardwood 300cm (7)
 Foundation beams, synthetic 300cm (7)
 Construction girders, hardwood 4.0x20.0x300cm (7)
 Hardwood stakes with point 6.0x6.0x75cm (35)
 Gutter set plastic 100mm (charcoal)
 Gutter set thermally galvanised 125mm
 Gutter plank (impr. Spruce, necessary for fitting a gutter) (4)
 Skylight (only with roofing felt and roof shingles)
 Roof covering kit (5)
 Glazing kit white
 Wooden floor 18mm (11)
 Wooden floor 18mm impregnated (11)
 Wooden floor 26mm (14)
 Wooden floor 26mm impregnated (14)
 Additional wall layer
 * Wide wind stop (impregnated spruce) (8)

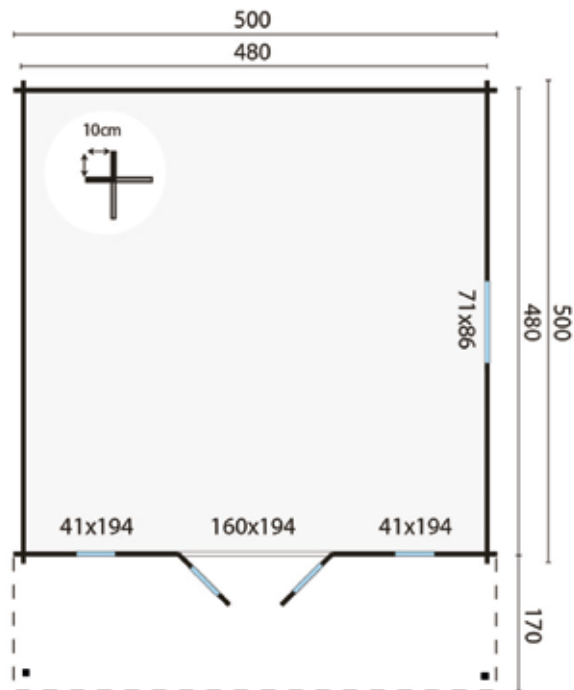

All options can be found from page 399 onwards
 Wooden floor under the Porch, see page 64 and 404

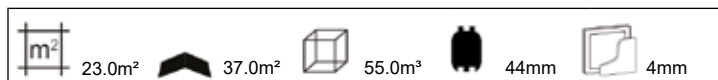

WOLFGANG - LOG CABIN



Optional roof shingles, straight (30m²)
 Optional roof shingles, beavertail (30m²)
 Optional roof shingles, hexagonal (30m²)

Optional roof tile profile boards (39m²)*
 Optional aquapan

Specifications:

Article no..... 40.0766
 Wood thickness 44mm
 Wood type spruce, untreated
 Dimensions.....530x300/450cm
 Foundation size510x280/430cm
 Ridge height approx. 250cm
 Windows 2 (can be opened)
 Glass double glazing

Supplied with separate bars for windows and doors

Can also be constructed in mirror image

Doors and windows can be placed to the left or to the right.

Side window in the extension can be placed to the front or the rear of the side wall

* Tip: When fitting roof tile profile boards we recommend that you also order the wide wind stops

The colour of the gutter planks and wind stops may differ somewhat

Optional extra's

Impregnation: Green, Brown, Silver-Grey

Impregnating Liquid in Green, Brown, Silver-Grey or Transparent (4)

Spray-applied base coat: White, Grey, Charcoal, Transparent Stain (7)

Carefree protect (7)

Foundation beams, impregnated 300cm (8)

Foundation beams, hardwood 300cm (8)

Foundation beams, synthetic 300cm (8)

Construction girders, hardwood 4.0x20.0x300cm (8)

Hardwood stakes with point 6.0x6.0x75cm (40)

Gutter set plastic 65mm (charcoal)

Gutter set plastic 100mm (charcoal)

Gutter set thermally galvanised 125mm

Gutter plank (impr. Spruce, necessary for fitting a gutter) (3)

Skylight (only with roofing felt and roof shingles)

Roof covering kit (5)

Glazing kit white

Wooden floor 18mm (9)

Wooden floor 18mm impregnated (9)

Wooden floor 26mm (11)

Wooden floor 26mm impregnated (11)

Additional wall layer

* Wide wind stop (impregnated spruce) (8)

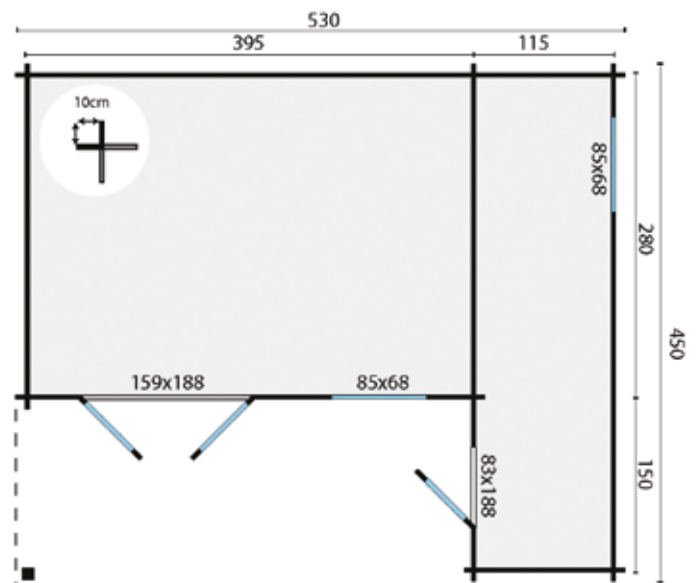

All options can be found from page 399 onwards
 Wooden floor under the Porch, see page 64 and 404

	11.3m ² 6.2m ²		27.0m ²		26.8m ³		44mm		4-6-4 mm
--	---	--	--------------------	--	--------------------	--	------	--	-------------

ERKE - LOG CABIN



- Optional roof shingles, straight (36m²)
- Optional roof shingles, beavertail (36m²)
- Optional roof shingles, hexagonal (36m²)

Specifications:

Article no..... 40.0782
 Wood thickness 44mm
 Wood type spruce, untreated
 Dimensions..... 430+155x330+200cm
 Foundation size 565x510cm
 Ridge height approx. 259cm
 Windows 2 (fixed), 1 (can be opened)
 Glass single glazing
 Supplied with fixed bars for windows and doors
 Can also be constructed in mirror image
 * Tip: When fitting roof tile profile boards we recommend that you also order the wide wind stops
 The colour of the gutter planks and wind stops may differ somewhat

Optional extra's

- Impregnation: Green, Brown, Silver-Grey
- Impregnating Liquid in Green, Brown, Silver-Grey or Transparent (5)
- Spray-applied base coat: White, Grey, Charcoal, Transparent
- Stain (10)
- Carefree protect (10)
- Starter's set (Nails, air vent & storm anchor set)
- Foundation beams, impregnated 300cm (10)
- Foundation beams, hardwood 300cm (10)
- Foundation beams, synthetic 300cm (10)
- Construction girders, hardwood 4.0x20.0x300cm (10)
- Hardwood stakes with point 6.0x6.0x75cm (50)
- Gutter set plastic 100mm (charcoal)
- Gutter set thermally galvanised 125mm
- Gutter plank (impr. Spruce, necessary for fitting a gutter) (3)
- Skylight (only with roofing felt and roof shingles)
- Roof covering kit (5)
- Glazing kit white
- Wooden floor 18mm (9)
- Wooden floor 18mm impregnated (9)
- Wooden floor 26mm (12)
- Wooden floor 26mm impregnated (12)
- Additional wall layer

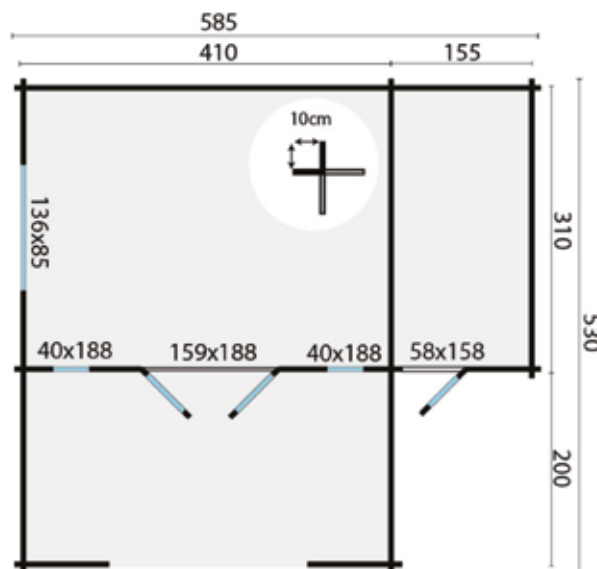

All options can be found from page 399 onwards
 Wooden floor under the Porch, see page 64 and 404

12.7m ²	32.1m ²	41.1m ³	44mm	4mm
4.6m ²				
8.2m ²				

LENNART - LOG CABIN

Optional roof shingles, straight (18m²)
 Optional roof shingles, beaver tail (18m²)
 Optional roof shingles, hexagonal (18m²)

Optional roof tile profile boards (19m²)*
 Optional aquapan

Specifications:

Article no..... 40.0830
 Wood thickness 58mm
 Wood type spruce, untreated
 Dimensions..... 300x300+90cm
 Foundation size 280x280cm
 Ridge height approx. 247cm
 Windows 1 (can be opened)
 Glass double glazing

Supplied with separate bars for windows and doors

Side window can be placed to the left or to the right

* Tip: When fitting roof tile profile boards we recommend that you also order the wide wind stops

The colour of the gutter planks and wind stops may differ somewhat

Optional extra's

Impregnation: Green, Brown, Silver-Grey

Impregnating Liquid in Green, Brown, Silver-Grey or Transparent (2)

Spray-applied base coat: White, Grey, Charcoal, Transparent

Stain (4)

Carefree protect (4)

Starter's set (Nails, air vent & storm anchor set)

Foundation beams, impregnated 300cm (4)

Foundation beams, hardwood 300cm (4)

Foundation beams, synthetic 300cm (4)

Construction girders, hardwood 4.0x20.0x300cm (4)

Hardwood stakes with point 6.0x6.0x75cm (20)

Gutter set plastic 65mm (charcoal)

Gutter set plastic 100mm (charcoal)

Gutter set thermally galvanised 125mm

Gutter plank (impr. Spruce, necessary for fitting a gutter) (2)

Skylight (only with roofing felt and roof shingles)

Roof covering kit (3)

Glazing kit white

Wooden floor 18mm (4)

Wooden floor 18mm impregnated (4)

Wooden floor 26mm (5)

Wooden floor 26mm impregnated (5)

Additional wall layer

* Wide wind stop (impregnated spruce) (3)

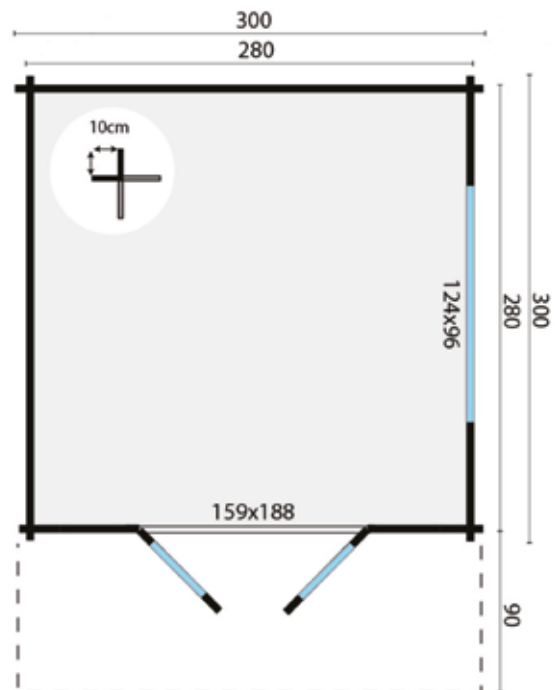

All options can be found from page 399 onwards



RORIK - LOG CABIN



Optional roof shingles, straight (24m²)
 Optional roof shingles, beavertail (24m²)
 Optional roof shingles, hexagonal (24m²)

Optional roof tile profile boards (23m²)*
 Optional aquapan

Specifications:

Article no..... 40.0831
 Wood thickness 58mm
 Wood type spruce, untreated
 Dimensions..... 400x300+90cm
 Foundation size 380x280cm
 Ridge height approx. 259cm
 Windows 1 (can be opened)
 Glass double glazing

Supplied with separate bars for windows and doors
 Doors and windows can be placed to the left or to the right.
 * Tip: When fitting roof tile profile boards we recommend that you also order the wide wind stops
 The colour of the gutter planks and wind stops may differ somewhat

Optional extra's

- Impregnation: Green, Brown, Silver-Grey
- Impregnating Liquid in Green, Brown, Silver-Grey or Transparent (2)
- Spray-applied base coat: White, Grey, Charcoal, Transparent
- Stain (4)
- Carefree protect (4)
- Starter's set (Nails, air vent & storm anchor set)
- Foundation beams, impregnated 300cm (5)
- Foundation beams, hardwood 300cm (5)
- Foundation beams, synthetic 300cm (5)
- Construction girders, hardwood 4.0x20.0x300cm (5)
- Hardwood stakes with point 6.0x6.0x75cm (25)
- Gutter set plastic 65mm (charcoal)
- Gutter set plastic 100mm (charcoal)
- Gutter set thermally galvanised 125mm
- Gutter plank (impr. Spruce, necessary for fitting a gutter) (2)
- Skylight (only with roofing felt and roof shingles)
- Roof covering kit (3)
- Glazing kit white
- Wooden floor 18mm (5)
- Wooden floor 18mm impregnated (5)
- Wooden floor 26mm (7)
- Wooden floor 26mm impregnated (7)
- Additional wall layer
- * Wide wind stop (impregnated spruce) (8)

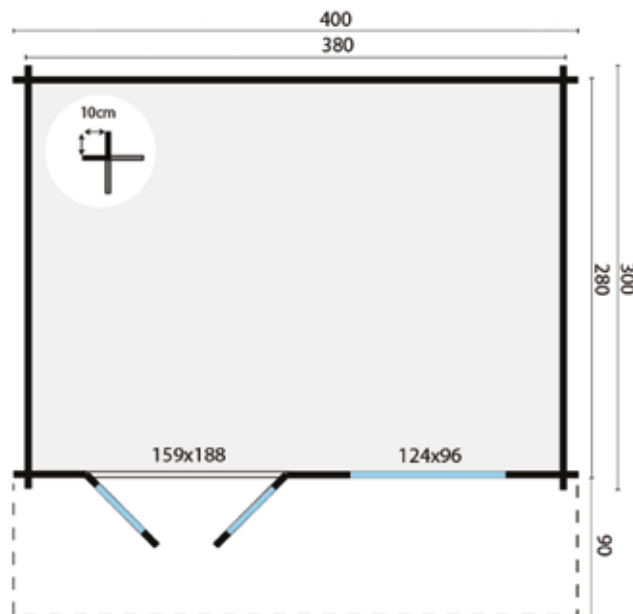

All options can be found from page 399 onwards

m² 10.6m²
16.4m²
24.5m³
58mm
4-6-4
4-16-4
mm

STIAN - LOG CABIN

Optional roof shingles, straight (30m²)
 Optional roof shingles, beavertail (30m²)
 Optional roof shingles, hexagonal (30m²)

Optional roof tile profile boards (32m²)*
 Optional aquapan

Specifications:

Article no..... 40.0832
 Wood thickness 58mm
 Wood type spruce, untreated
 Dimensions..... 400x400+140cm
 Foundation size 380x380cm
 Ridge height approx. 250cm
 Windows 1 (can be opened)
 Glass double glazing

Supplied with separate bars for windows and doors

Doors and windows can be placed to the left or to the right.

* Tip: When fitting roof tile profile boards we recommend that you also order the wide wind stops

The colour of the gutter planks and wind stops may differ somewhat

Optional extra's

Impregnation: Green, Brown, Silver-Grey
 Impregnating Liquid in Green, Brown, Silver-Grey or Transparent (3)
 Spray-applied base coat: White, Grey, Charcoal, Transparent
 Stain (5)
 Carefree protect (5)
 Starter's set (Nails, air vent & storm anchor set)
 Foundation beams, impregnated 300cm (6)
 Foundation beams, hardwood 300cm (6)
 Foundation beams, synthetic 300cm (6)
 Construction girders, hardwood 4.0x20.0x300cm (6)
 Hardwood stakes with point 6.0x6.0x75cm (30)
 Gutter set plastic 65mm (charcoal)
 Gutter set plastic 100mm (charcoal)
 Gutter set thermally galvanised 125mm
 Gutter plank (impr. Spruce, necessary for fitting a gutter) (3)
 Skylight (only with roofing felt and roof shingles)
 Roof covering kit (4)
 Glazing kit white
 Wooden floor 18mm (6)
 Wooden floor 18mm impregnated (6)
 Wooden floor 26mm (9)
 Wooden floor 26mm impregnated (9)
 Additional wall layer
 * Wide wind stop (impregnated spruce) (8)

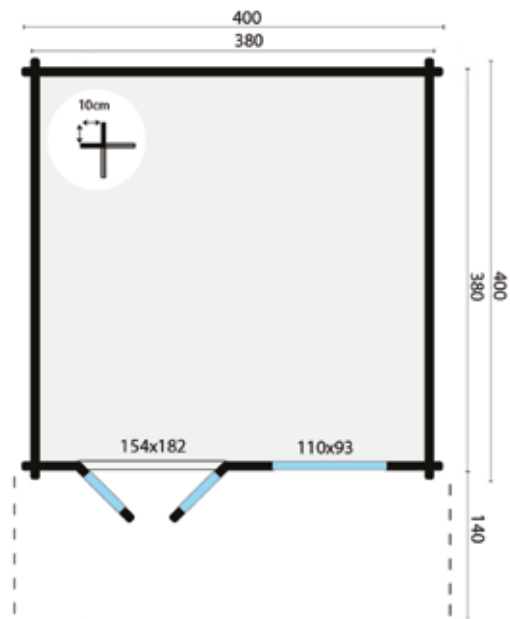

All options can be found from page 399 onwards



BLACKPOOL - LOG CABIN



Optional roof shingles, straight (24m²)
 Optional roof shingles, beavertail (24m²)
 Optional roof shingles, hexagonal (24m²)

Optional roof tile profile boards (26m²)*
 Optional aquapan

Specifications:

Article no..... 40.7001
 Wood thickness 58mm
 Wood type spruce, untreated
 Dimensions..... 440x340+90cm
 Foundation size 420x320cm
 Ridge height approx. 259cm
 Windows 2 (fixed), 1 (can be opened)
 Glass double glazing

Supplied with fixed bars for windows and doors
 Side window can be placed to the left or to the right
 * Tip: When fitting roof tile profile boards we recommend that you also order the wide wind stops
 The colour of the gutter planks and wind stops may differ somewhat

Optional extra's

- Impregnation: Green, Brown, Silver-Grey
- Impregnating Liquid in Green, Brown, Silver-Grey or Transparent (3)
- Spray-applied base coat: White, Grey, Charcoal, Transparent
- Stain (6)
- Carefree protect (6)
- Starter's set (Nails, air vent & storm anchor set)
- Foundation beams, impregnated 300cm (5)
- Foundation beams, hardwood 300cm (5)
- Foundation beams, synthetic 300cm (5)
- Construction girders, hardwood 4.0x20.0x300cm (5)
- Hardwood stakes with point 6.0x6.0x75cm (25)
- Gutter set plastic 100mm (charcoal)
- Gutter set thermally galvanised 125mm
- Gutter plank (impr. Spruce, necessary for fitting a gutter) (3)
- Skylight (only with roofing felt and roof shingles)
- Roof covering kit (4)
- Glazing kit white
- Wooden floor 18mm (7)
- Wooden floor 18mm impregnated (7)
- Wooden floor 26mm (9)
- Wooden floor 26mm impregnated (9)
- Additional wall layer
- * Wide wind stop (impregnated spruce) (8)

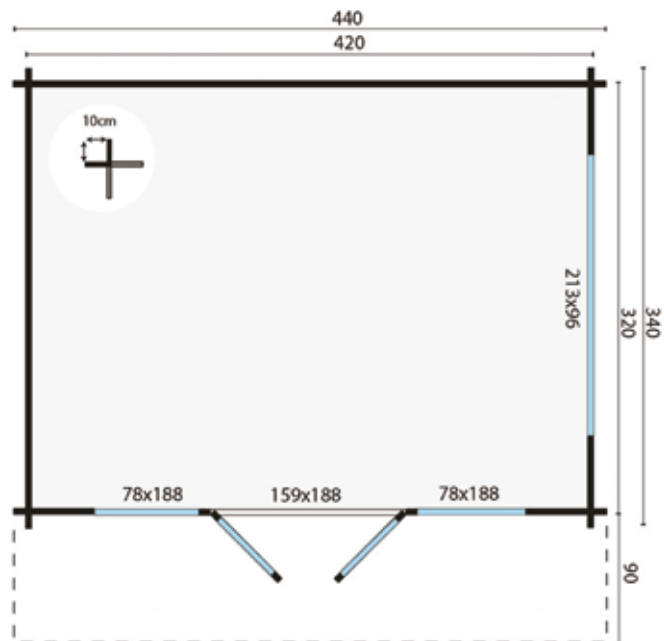

All options can be found from page 399 onwards

13.4m²
20.2m²
31.0m³
58mm
4-6-4 mm

BOLTON - LOG CABIN

Optional roof shingles, straight (30m²)
 Optional roof shingles, beavertail (30m²)
 Optional roof shingles, hexagonal (30m²)

Optional roof tile profile boards (36m²)*
 Optional aquapan

Specifications:

Article no..... 40.7002
 Wood thickness 58mm
 Wood type spruce, untreated
 Dimensions..... 440x340+223cm
 Foundation size 420x543cm
 Ridge height approx. 263cm
 Windows 2 (fixed), 1 (can be opened)
 Glass double glazing

Supplied with separate bars for windows and doors

Side window can be placed to the left or to the right

* Tip: When fitting roof tile profile boards we recommend that you also order the wide wind stops

The colour of the gutter planks and wind stops may differ somewhat

Optional extra's

Impregnation: Green, Brown, Silver-Grey

Impregnating Liquid in Green, Brown, Silver-Grey or Transparent (3)

Spray-applied base coat: White, Grey, Charcoal, Transparent

Stain (6)

Carefree protect (6)

Starter's set (Nails, air vent & storm anchor set)

Foundation beams, impregnated 300cm (8)

Foundation beams, hardwood 300cm (8)

Foundation beams, synthetic 300cm (8)

Construction girders, hardwood 4.0x20.0x300cm (8)

Hardwood stakes with point 6.0x6.0x75cm (40)

Gutter set plastic 100mm (charcoal)

Gutter set thermally galvanised 125mm

Gutter plank (impr. Spruce, necessary for fitting a gutter) (4)

Skylight (only with roofing felt and roof shingles)

Roof covering kit (5)

Glazing kit white

Wooden floor 18mm (7)

Wooden floor 18mm impregnated (7)

Wooden floor 26mm (9)

Wooden floor 26mm impregnated (9)

Additional wall layer

* Wide wind stop (impregnated spruce) (8)

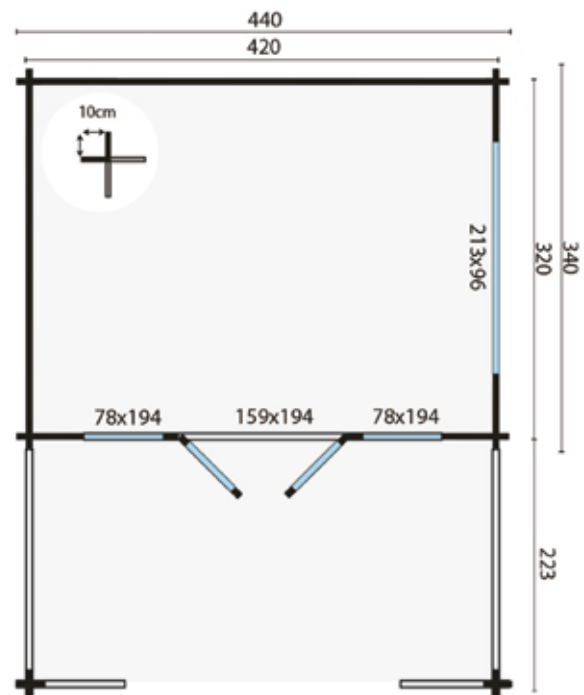

All options can be found from page 399 onwards
 Wooden floor under the Porch, see page 64 and 404

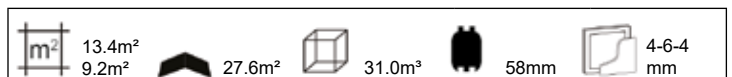

BRISTOL - LOG CABIN



Optional roof shingles, straight (36m²)
 Optional roof shingles, beavertail (36m²)
 Optional roof shingles, hexagonal (36m²)

Optional roof tile profile boards (40m²)*
 Optional aquapan

Specifications:

Article no..... 40.7010
 Wood thickness 58mm
 Wood type spruce, untreated
 Dimensions..... 440x340+290cm
 Foundation size 420x610cm
 Ridge height approx. 256cm
 Windows 2 (fixed), 1 (can be opened)
 Glass double glazing

Supplied with separate bars for windows and doors
 Side window can be placed to the left or to the right
 * Tip: When fitting roof tile profile boards we recommend that you also order the wide wind stops
 The colour of the gutter planks and wind stops may differ somewhat

Optional extra's

- Impregnation: Green, Brown, Silver-Grey
- Impregnating Liquid in Green, Brown, Silver-Grey or Transparent (3)
- Spray-applied base coat: White, Grey, Charcoal, Transparent
- Stain (6)
- Carefree protect (6)
- Starter's set (Nails, air vent & storm anchor set)
- Foundation beams, impregnated 300cm (9)
- Foundation beams, hardwood 300cm (9)
- Foundation beams, synthetic 300cm (9)
- Construction girders, hardwood 4.0x20.0x300cm (9)
- Hardwood stakes with point 6.0x6.0x75cm (45)
- Gutter set plastic 100mm (charcoal)
- Gutter set thermally galvanised 125mm
- Gutter plank (impr. Spruce, necessary for fitting a gutter) (4)
- Skylight (only with roofing felt and roof shingles)
- Roof covering kit (5)
- Glazing kit white
- Wooden floor 18mm (7)
- Wooden floor 18mm impregnated (7)
- Wooden floor 26mm (9)
- Wooden floor 26mm impregnated (9)
- Additional wall layer
- * Wide wind stop (impregnated spruce) (8)

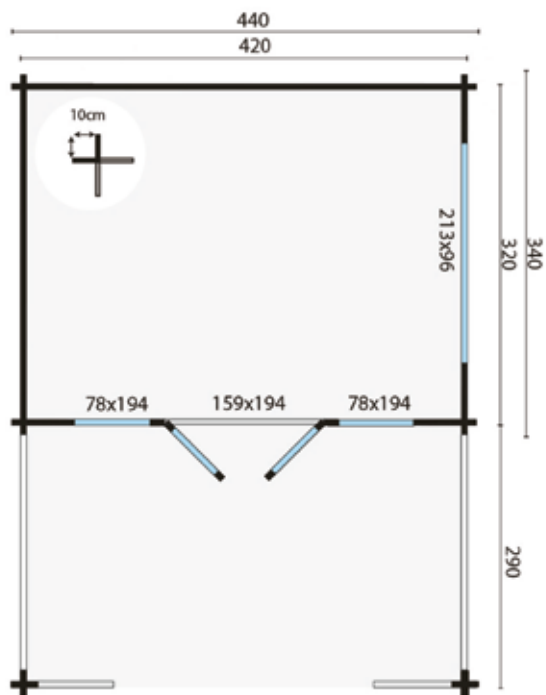

All options can be found from page 399 onwards
 Wooden floor under the Porch, see page 64 and 404

	13.4m ²		29.9m ²		31.0m ³		58mm		4-6-4 mm
--	--------------------	--	--------------------	--	--------------------	--	------	--	----------

COVENTRY - LOG CABIN



- Optional roof shingles, straight (33m²)
- Optional roof shingles, beavertail (33m²)
- Optional roof shingles, hexagonal (33m²)

Specifications:

Article no..... 40.7003
 Wood thickness 58mm
 Wood type spruce, untreated
 Dimensions..... 440+150x340+223cm
 Foundation size 570x543cm
 Ridge height approx. 263cm
 Windows 2 (fixed), 1 (can be opened)
 Glass double glazing
 Supplied with separate bars for windows and doors
 Can also be constructed in mirror image

Optional extra's

- Impregnation: Green, Brown, Silver-Grey
- Impregnating Liquid in Green, Brown, Silver-Grey or Transparent (5)
- Spray-applied base coat: White, Grey, Charcoal, Transparent
- Stain (10)
- Carefree protect (10)
- Starter's set (Nails, air vent & storm anchor set)
- Foundation beams, impregnated 300cm (10)
- Foundation beams, hardwood 300cm (10)
- Foundation beams, synthetic 300cm (10)
- Construction girders, hardwood 4.0x20.0x300cm (10)
- Hardwood stakes with point 6.0x6.0x75cm (50)
- Gutter set plastic 100mm (charcoal)
- Gutter set thermally galvanised 125mm
- Gutter plank (impr. Spruce, necessary for fitting a gutter) (3)
- Skylight (only with roofing felt and roof shingles)
- Roof covering kit (5)
- Glazing kit white
- Wooden floor 18mm (9)
- Wooden floor 18mm impregnated (9)
- Wooden floor 26mm (12)
- Wooden floor 26mm impregnated (12)
- Additional wall layer

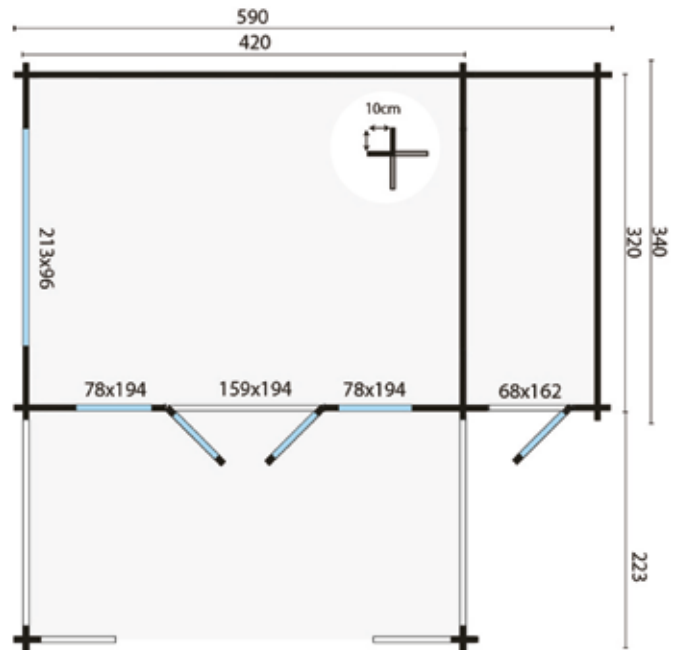

All options can be found from page 399 onwards
 Wooden floor under the Porch, see page 64 and 404

13.4m ²	37.3m ²	41.9m ³	58mm	4-6-4 mm
4.8m ²				
9.2m ²				

DERBY - LOG CABIN



Optional roof shingles, straight (27m²)
 Optional roof shingles, beavertail (27m²)
 Optional roof shingles, hexagonal (27m²)

Optional roof tile profile boards (32m²)*
 Optional aquapan

Specifications:

Article no..... 40.7004
 Wood thickness 58mm
 Wood type spruce, untreated
 Dimensions..... 440x440+90cm
 Foundation size 420x420cm
 Ridge height approx. 263cm
 Windows 2 (fixed), 1 (can be opened)
 Glass double glazing

Supplied with separate bars for windows and doors

Side window can be placed to the left or to the right

* Tip: When fitting roof tile profile boards we recommend that you also order the wide wind stops

The colour of the gutter planks and wind stops may differ somewhat

Optional extra's

- Impregnation: Green, Brown, Silver-Grey
- Impregnating Liquid in Green, Brown, Silver-Grey or Transparent (3)
- Spray-applied base coat: White, Grey, Charcoal, Transparent
- Stain (5)
- Carefree protect (5)
- Starter's set (Nails, air vent & storm anchor set)
- Foundation beams, impregnated 300cm (6)
- Foundation beams, hardwood 300cm (6)
- Foundation beams, synthetic 300cm (6)
- Construction girders, hardwood 4.0x20.0x300cm (6)
- Hardwood stakes with point 6.0x6.0x75cm (30)
- Gutter set plastic 100mm (charcoal)
- Gutter set thermally galvanised 125mm
- Gutter plank (impr. Spruce, necessary for fitting a gutter) (3)
- Skylight (only with roofing felt and roof shingles)
- Roof covering kit (4)
- Glazing kit white
- Wooden floor 18mm (8)
- Wooden floor 18mm impregnated (8)
- Wooden floor 26mm (11)
- Wooden floor 26mm impregnated (11)
- Additional wall layer
- * Wide wind stop (impregnated spruce) (8)

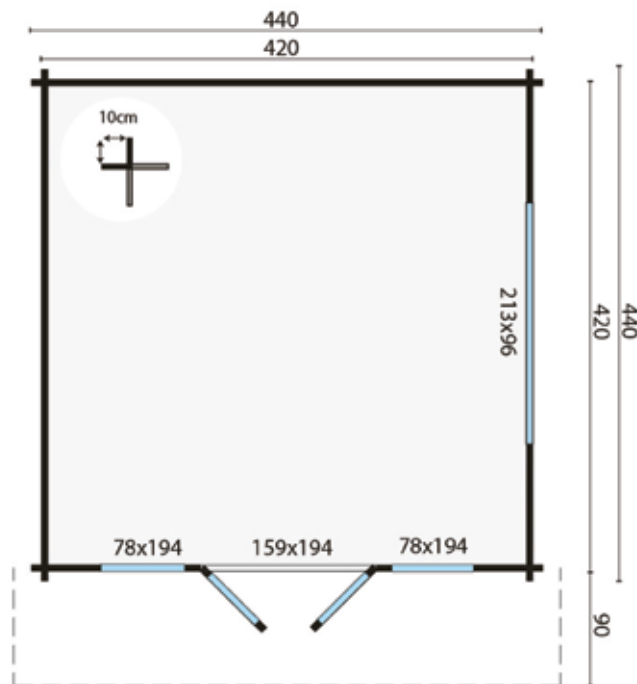

All options can be found from page 399 onwards

m² 17.6m²
 25.1m²
 40.5m³
 58mm
 4-6-4 mm

IPSWICH - LOG CABIN



Optional roof shingles, straight (36m²)
 Optional roof shingles, beavertail (36m²)
 Optional roof shingles, hexagonal (36m²)

Optional roof tile profile boards (39m²)*
 Optional aquapan

Specifications:

Article no..... 40.7005
 Wood thickness 58mm
 Wood type spruce, untreated
 Dimensions..... 440x440+223cm
 Foundation size 420x643cm
 Ridge height approx. 256cm
 Windows 2 (fixed), 1 (can be opened)
 Glass double glazing

Supplied with separate bars for windows and doors

Side window can be placed to the left or to the right

* Tip: When fitting roof tile profile boards we recommend that you also order the wide wind stops

The colour of the gutter planks and wind stops may differ somewhat

Optional extra's

Impregnation: Green, Brown, Silver-Grey

Impregnating Liquid in Green, Brown, Silver-Grey or Transparent (4)

Spray-applied base coat: White, Grey, Charcoal, Transparent

Stain (7)

Carefree protect (7)

Starter's set (Nails, air vent & storm anchor set)

Foundation beams, impregnated 300cm (8)

Foundation beams, hardwood 300cm (8)

Foundation beams, synthetic 300cm (8)

Construction girders, hardwood 4.0x20.0x300cm (8)

Hardwood stakes with point 6.0x6.0x75cm (40)

Gutter set plastic 100mm (charcoal)

Gutter set thermally galvanised 125mm

Gutter plank (impr. Spruce, necessary for fitting a gutter) (4)

Skylight (only with roofing felt and roof shingles)

Roof covering kit (5)

Glazing kit white

Wooden floor 18mm (8)

Wooden floor 18mm impregnated (8)

Wooden floor 26mm (11)

Wooden floor 26mm impregnated (11)

Additional wall layer

* Wide wind stop (impregnated spruce) (8)

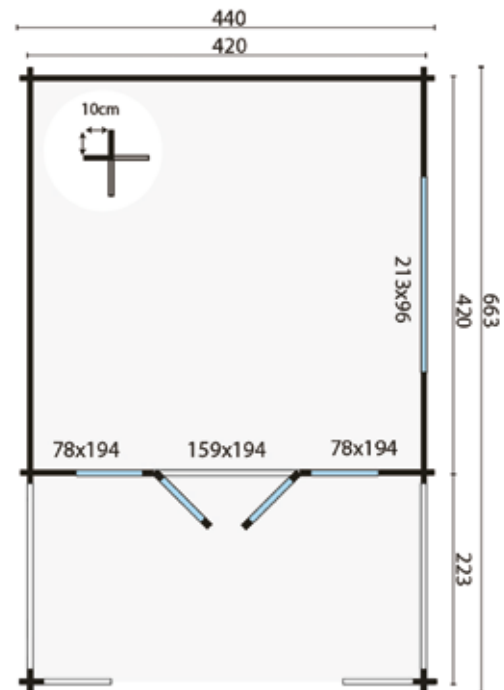

All options can be found from page 399 onwards
 Wooden floor under the Porch, see page 64 and 404

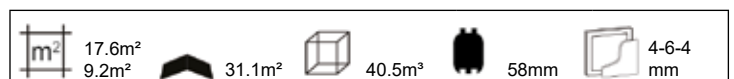

LEEDS - LOG CABIN



Optional roof shingles, straight (42m²)
 Optional roof shingles, beavertail (42m²)
 Optional roof shingles, hexagonal (42m²)

Optional roof tile profile boards (44m²)*
 Optional aquapan

Specifications:

Article no..... 40.7011
 Wood thickness 58mm
 Wood type spruce, untreated
 Dimensions..... 440x440+290cm
 Foundation size 420x710cm
 Ridge height approx. 256cm
 Windows 2 (fixed), 1 (can be opened)
 Glass double glazing

Supplied with separate bars for windows and doors
 Side window can be placed to the left or to the right
 * Tip: When fitting roof tile profile boards we recommend that you also order the wide wind stops
 The colour of the gutter planks and wind stops may differ somewhat

Optional extra's

- Impregnation: Green, Brown, Silver-Grey
- Impregnating Liquid in Green, Brown, Silver-Grey or Transparent (4)
- Spray-applied base coat: White, Grey, Charcoal, Transparent
- Stain (7)
- Carefree protect (7)
- Starter's set (Nails, air vent & storm anchor set)
- Foundation beams, impregnated 300cm (9)
- Foundation beams, hardwood 300cm (9)
- Foundation beams, synthetic 300cm (9)
- Construction girders, hardwood 4.0x20.0x300cm (9)
- Hardwood stakes with point 6.0x6.0x75cm (45)
- Gutter set plastic 100mm (charcoal)
- Gutter set thermally galvanised 125mm
- Gutter plank (impr. Spruce, necessary for fitting a gutter) (4)
- Skylight (only with roofing felt and roof shingles)
- Roof covering kit (5)
- Glazing kit white
- Wooden floor 18mm (8)
- Wooden floor 18mm impregnated (8)
- Wooden floor 26mm (11)
- Wooden floor 26mm impregnated (11)
- Additional wall layer
- * Wide wind stop (impregnated spruce) (8)

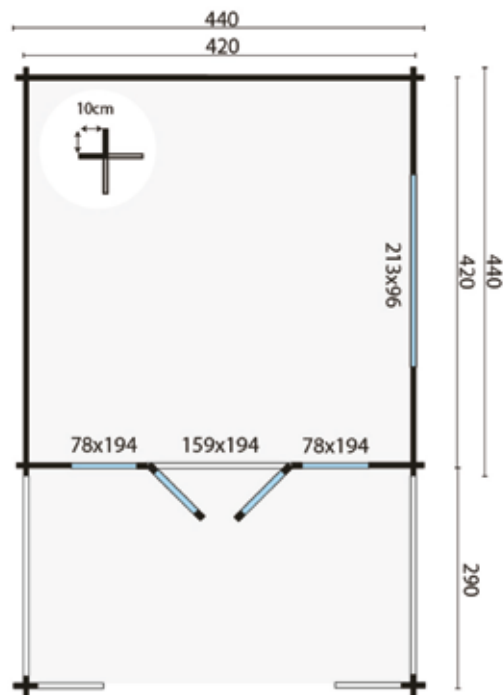

All options can be found from page 399 onwards
 Wooden floor under the Porch, see page 64 and 404

	17.6m ²		35.6m ²		40.5m ³		58mm		4-6-4 mm
--	--------------------	--	--------------------	--	--------------------	--	------	--	----------

MANCHESTER - LOG CABIN



Optional roof shingles, straight (42m²)
 Optional roof shingles, beavertail (42m²)
 Optional roof shingles, hexagonal (42m²)

Specifications:

Article no..... 40.7006
 Wood thickness 58mm
 Wood type spruce, untreated
 Dimensions..... 440+154x440+223cm
 Foundation size 574x643cm
 Ridge height approx. 263cm
 Windows 2 (fixed), 1 (can be opened)
 Glass double glazing
 Supplied with separate bars for windows and doors
 Can also be constructed in mirror image

Optional extra's

Impregnation: Green, Brown, Silver-Grey
 Impregnating Liquid in Green, Brown, Silver-Grey or Transparent (5)
 Spray-applied base coat: White, Grey, Charcoal, Transparent
 Stain (9)
 Carefree protect (9)
 Starter's set (Nails, air vent & storm anchor set)
 Foundation beams, impregnated 300cm (11)
 Foundation beams, hardwood 300cm (11)
 Foundation beams, synthetic 300cm (11)
 Construction girders, hardwood 4.0x20.0x300cm (11)
 Hardwood stakes with point 6.0x6.0x75cm (55)
 Gutter set plastic 100mm (charcoal)
 Gutter set thermally galvanised 125mm
 Gutter plank (impr. Spruce, necessary for fitting a gutter) (4)
 Skylight (only with roofing felt and roof shingles)
 Roof covering kit (5)
 Glazing kit white
 Wooden floor 18mm (12)
 Wooden floor 18mm impregnated (12)
 Wooden floor 26mm (15)
 Wooden floor 26mm impregnated (15)
 Additional wall layer

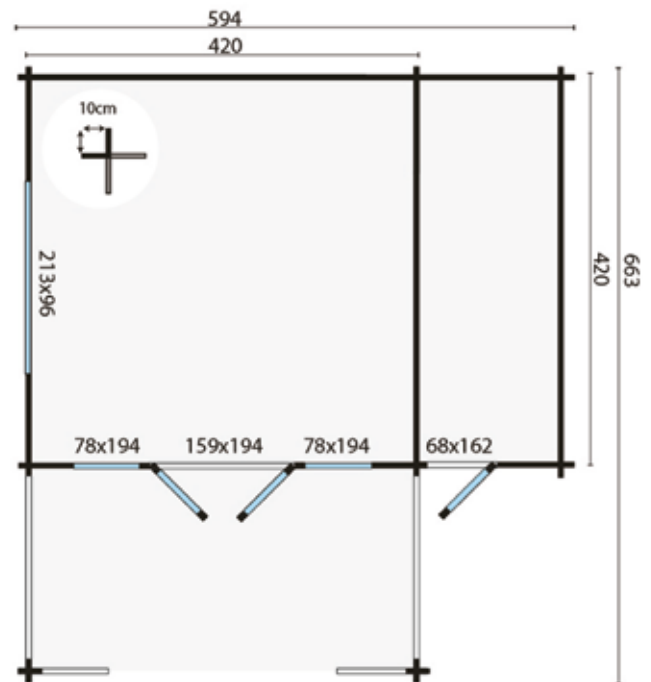

All options can be found from page 399 onwards
 Wooden floor under the Porch, see page 64 and 404

17.6m ²	44.4m ²	55.4m ³	58mm	4-6-4 mm
6.5m ²				
9.2m ²				

NEWCASTLE - LOG CABIN



Optional roof shingles, straight (33m²)
 Optional roof shingles, beavertail (33m²)
 Optional roof shingles, hexagonal (33m²)

Optional roof tile profile boards (36m²)*
 Optional aquapan

Specifications:

Article no..... 40.7013
 Wood thickness 58mm
 Wood type spruce, untreated
 Dimensions..... 540x440+90cm
 Foundation size 520x420cm
 Ridge height approx. 276cm
 Windows 2 (fixed), 1 (can be opened)
 Glass double glazing

Supplied with separate bars for windows and doors

Side window can be placed to the left or to the right

* Tip: When fitting roof tile profile boards we recommend that you also order the wide wind stops

The colour of the gutter planks and wind stops may differ somewhat

Optional extra's

- Impregnation: Green, Brown, Silver-Grey
- Impregnating Liquid in Green, Brown, Silver-Grey or Transparent (3)
- Spray-applied base coat: White, Grey, Charcoal, Transparent
- Stain (6)
- Carefree protect (6)
- Starter's set (Nails, air vent & storm anchor set)
- Foundation beams, impregnated 300cm (7)
- Foundation beams, hardwood 300cm (7)
- Foundation beams, synthetic 300cm (7)
- Construction girders, hardwood 4.0x20.0x300cm (7)
- Hardwood stakes with point 6.0x6.0x75cm (35)
- Gutter set plastic 100mm (charcoal)
- Gutter set thermally galvanised 125mm
- Gutter plank (impr. Spruce, necessary for fitting a gutter) (3)
- Skylight (only with roofing felt and roof shingles)
- Roof covering kit (5)
- Glazing kit white
- Wooden floor 18mm (10)
- Wooden floor 18mm impregnated (10)
- Wooden floor 26mm (14)
- Wooden floor 26mm impregnated (14)
- Additional wall layer
- * Wide wind stop (impregnated spruce) (8)

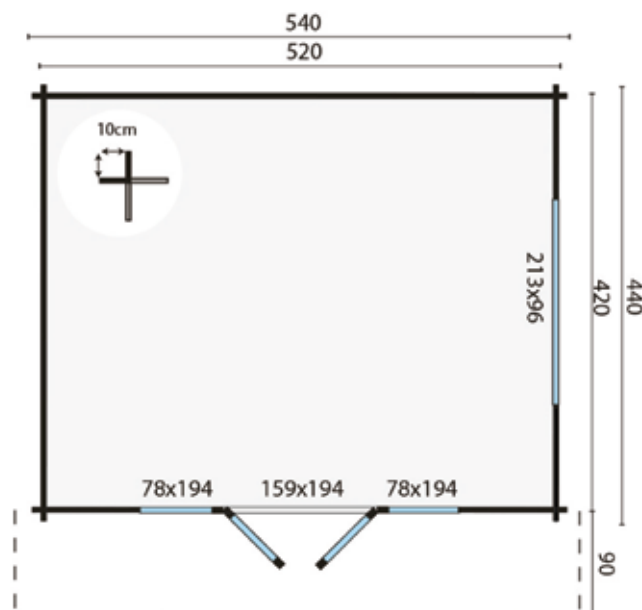

All options can be found from page 399 onwards

m² 21.8m²
▲ 29.7m²
◻ 50.0m³
■ 58mm
 □ 4-6-4 mm

NOTTINGHAM - LOG CABIN



Optional roof shingles, straight (42m²)
 Optional roof shingles, beavertail (42m²)
 Optional roof shingles, hexagonal (42m²)

Optional roof tile profile boards (42m²)*
 Optional aquapan

Specifications:

Article no..... 40.7014
 Wood thickness 58mm
 Wood type spruce, untreated
 Dimensions..... 540x440+223cm
 Foundation size 520x643cm
 Ridge height approx. 270cm
 Windows 2 (fixed), 1 (can be opened)
 Glass double glazing

Supplied with fixed bars for windows and doors

Side window can be placed to the left or to the right

* Tip: When fitting roof tile profile boards we recommend that you also order the wide wind stops

The colour of the gutter planks and wind stops may differ somewhat

Optional extra's

Impregnation: Green, Brown, Silver-Grey

Impregnating Liquid in Green, Brown, Silver-Grey or Transparent (4)

Spray-applied base coat: White, Grey, Charcoal, Transparent

Stain (7)

Carefree protect (7)

Starter's set (Nails, air vent & storm anchor set)

Foundation beams, impregnated 300cm (9)

Foundation beams, hardwood 300cm (9)

Foundation beams, synthetic 300cm (9)

Construction girders, hardwood 4.0x20.0x300cm (9)

Hardwood stakes with point 6.0x6.0x75cm (45)

Gutter set plastic 100mm (charcoal)

Gutter set thermally galvanised 125mm

Gutter plank (impr. Spruce, necessary for fitting a gutter) (4)

Skylight (only with roofing felt and roof shingles)

Roof covering kit (5)

Glazing kit white

Wooden floor 18mm (10)

Wooden floor 18mm impregnated (10)

Wooden floor 26mm (14)

Wooden floor 26mm impregnated (14)

Additional wall layer

* Wide wind stop (impregnated spruce) (8)

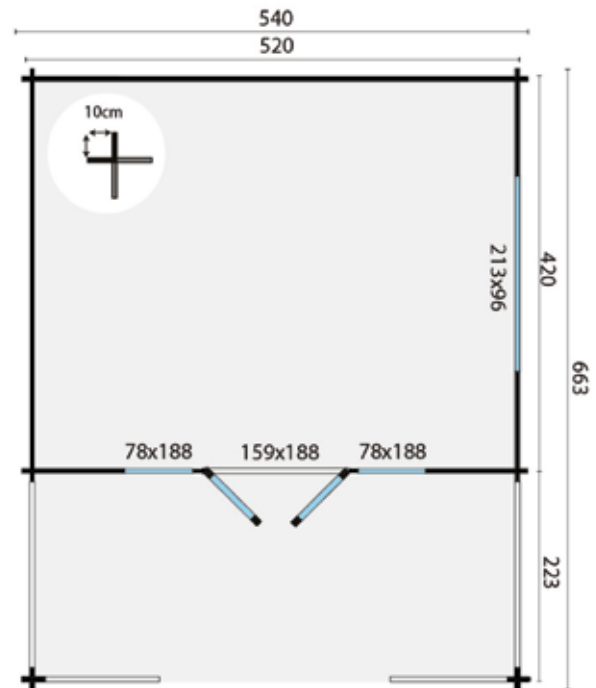

All options can be found from page 399 onwards
 Wooden floor under the Porch, see page 64 and 404

	21.8m ² 11.4m ²		39.3m ²		50.0m ³		58mm		4-6-4 mm
--	--	--	--------------------	--	--------------------	--	------	--	-------------

SOUTHAMPTON - LOG CABIN



Optional roof shingles, straight (39m²)
 Optional roof shingles, beavertail (39m²)
 Optional roof shingles, hexagonal (39m²)

Optional roof tile profile boards (39m²)*
 Optional aquapan

Specifications:

Article no..... 40.7007
 Wood thickness 58mm
 Wood type spruce, untreated
 Dimensions..... 540x540+60cm
 Foundation size 520x520cm
 Ridge height approx. 276cm
 Windows 2 (fixed), 1 (can be opened)
 Glass double glazing

Supplied with separate bars for windows and doors

Side window can be placed to the left or to the right

* Tip: When fitting roof tile profile boards we recommend that you also order the wide wind stops

The colour of the gutter planks and wind stops may differ somewhat

Optional extra's

- Impregnation: Green, Brown, Silver-Grey
- Impregnating Liquid in Green, Brown, Silver-Grey or Transparent (4)
- Spray-applied base coat: White, Grey, Charcoal, Transparent
- Stain (7)
- Carefree protect (7)
- Starter's set (Nails, air vent & storm anchor set)
- Foundation beams, impregnated 300cm (8)
- Foundation beams, hardwood 300cm (8)
- Foundation beams, synthetic 300cm (8)
- Construction girders, hardwood 4.0x20.0x300cm (8)
- Hardwood stakes with point 6.0x6.0x75cm (40)
- Gutter set plastic 100mm (charcoal)
- Gutter set thermally galvanised 125mm
- Gutter plank (impr. Spruce, necessary for fitting a gutter) (4)
- Skylight (only with roofing felt and roof shingles)
- Roof covering kit (5)
- Glazing kit white
- Wooden floor 18mm (13)
- Wooden floor 18mm impregnated (13)
- Wooden floor 26mm (17)
- Wooden floor 26mm impregnated (17)
- Additional wall layer
- * Wide wind stop (impregnated spruce) (8)

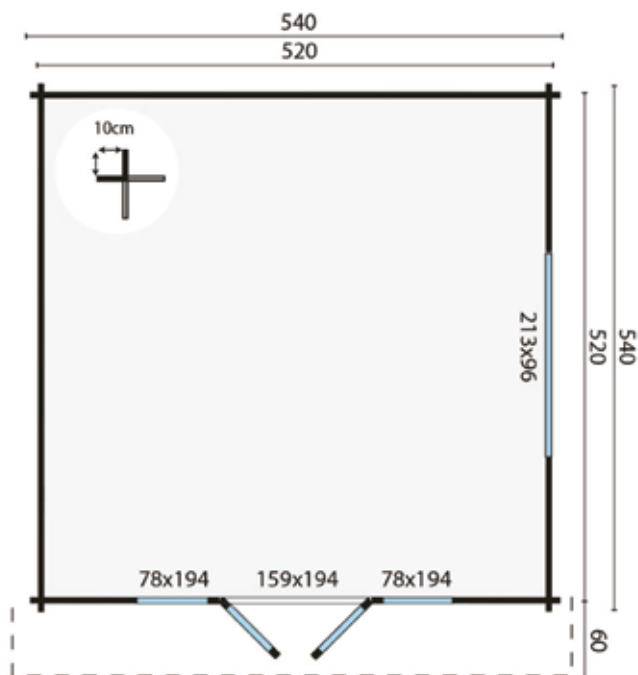

All options can be found from page 399 onwards

m² 27.0m²
 34.6m²
 62.0m³
 58mm
 4-6-4 mm

WIGAN - LOG CABIN



Optional roof shingles, straight (48m²)
 Optional roof shingles, beavertail (48m²)
 Optional roof shingles, hexagonal (48m²)

Optional roof tile profile boards (46m²)*
 Optional aquapan

Specifications:

Article no..... 40.7008
 Wood thickness 58mm
 Wood type spruce, untreated
 Dimensions..... 540x540+223cm
 Foundation size 520x743cm
 Ridge height approx. 263cm
 Windows 2 (fixed), 1 (can be opened)
 Glass double glazing

Supplied with separate bars for windows and doors

Side window can be placed to the left or to the right

* Tip: When fitting roof tile profile boards we recommend that you also order the wide wind stops

The colour of the gutter planks and wind stops may differ somewhat

Optional extra's

Impregnation: Green, Brown, Silver-Grey

Impregnating Liquid in Green, Brown, Silver-Grey or Transparent (4)

Spray-applied base coat: White, Grey, Charcoal, Transparent

Stain (8)

Carefree protect (8)

Starter's set (Nails, air vent & storm anchor set)

Foundation beams, impregnated 300cm (11)

Foundation beams, hardwood 300cm (11)

Foundation beams, synthetic 300cm (11)

Construction girders, hardwood 4.0x20.0x300cm (11)

Hardwood stakes with point 6.0x6.0x75cm (55)

Gutter set plastic 100mm (charcoal)

Gutter set thermally galvanised 125mm

Gutter plank (impr. Spruce, necessary for fitting a gutter) (4)

Skylight (only with roofing felt and roof shingles)

Roof covering kit (6)

Glazing kit white

Wooden floor 18mm (13)

Wooden floor 18mm impregnated (13)

Wooden floor 26mm (17)

Wooden floor 26mm impregnated (17)

Additional wall layer

* Wide wind stop (impregnated spruce) (8)

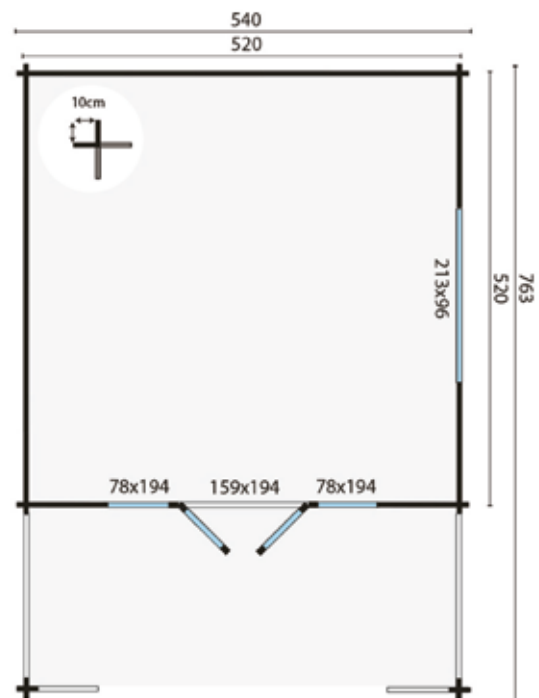

All options can be found from page 399 onwards
 Wooden floor under the Porch, see page 64 and 404

27.0m ²	41.1m ²	62.0m ³	58mm	4-6-4 mm
11.4m ²				

WATFORD - LOG CABIN



Optional roof shingles, straight (54m²)
 Optional roof shingles, beavertail (54m²)
 Optional roof shingles, hexagonal (54m²)

Optional roof tile profile boards (50m²)*
 Optional aquapan

Specifications:

Article no..... 40.7012
 Wood thickness 58mm
 Wood type spruce, untreated
 Dimensions..... 540x540+290cm
 Foundation size 520x810cm
 Ridge height approx. 276cm
 Windows 2 (fixed), 1 (can be opened)
 Glass double glazing

Supplied with separate bars for windows and doors

Side window can be placed to the left or to the right

* Tip: When fitting roof tile profile boards we recommend that you also order the wide wind stops

The colour of the gutter planks and wind stops may differ somewhat

Optional extra's

- Impregnation: Green, Brown, Silver-Grey
- Impregnating Liquid in Green, Brown, Silver-Grey or Transparent (4)
- Spray-applied base coat: White, Grey, Charcoal, Transparent
- Stain (8)
- Carefree protect (8)
- Starter's set (Nails, air vent & storm anchor set)
- Foundation beams, impregnated 300cm (11)
- Foundation beams, hardwood 300cm (11)
- Foundation beams, synthetic 300cm (11)
- Construction girders, hardwood 4.0x20.0x300cm (11)
- Hardwood stakes with point 6.0x6.0x75cm (55)
- Gutter set plastic 100mm (charcoal)
- Gutter set thermally galvanised 125mm
- Gutter plank (impr. Spruce, necessary for fitting a gutter) (5)
- Skylight (only with roofing felt and roof shingles)
- Roof covering kit (6)
- Glazing kit white
- Wooden floor 18mm (13)
- Wooden floor 18mm impregnated (13)
- Wooden floor 26mm (17)
- Wooden floor 26mm impregnated (17)
- Additional wall layer
- * Wide wind stop (impregnated spruce) (8)

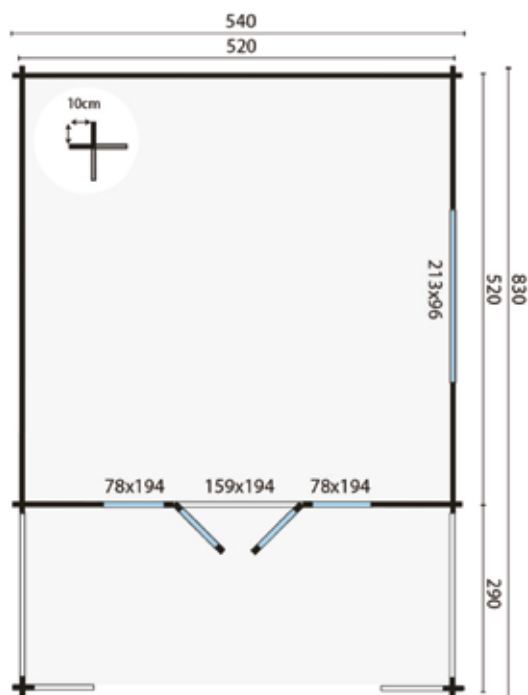

All options can be found from page 399 onwards
 Wooden floor under the Porch, see page 64 and 404

27.0m ²	49.0m ²	62.0m ³	58mm	4-6-4 mm
15.0m ²				

LIVERPOOL - LOG CABIN



- Optional roof shingles, straight (57m²)
- Optional roof shingles, beavertail (57m²)
- Optional roof shingles, hexagonal (57m²)

Specifications:

- Article no..... 40.7009
- Wood thickness 58mm
- Wood type spruce, untreated
- Dimensions..... 540+154x540+223cm
- Foundation size 674x743cm
- Ridge height approx. 263cm
- Windows 2 (fixed), 1 (can be opened)
- Glass double glazing
- Supplied with separate bars for windows and doors
- Can also be constructed in mirror image

Optional extra's

- Impregnation: Green, Brown, Silver-Grey
- Impregnating Liquid in Green, Brown, Silver-Grey or Transparent (5)
- Spray-applied base coat: White, Grey, Charcoal, Transparent
- Stain (9)
- Carefree protect (9)
- Starter's set (Nails, air vent & storm anchor set)
- Foundation beams, impregnated 300cm (12)
- Foundation beams, hardwood 300cm (12)
- Foundation beams, synthetic 300cm (12)
- Construction girders, hardwood 4.0x20.0x300cm (12)
- Hardwood stakes with point 6.0x6.0x75cm (60)
- Gutter set plastic 100mm (charcoal)
- Gutter set thermally galvanised 125mm
- Gutter plank (impr. Spruce, necessary for fitting a gutter) (4)
- Skylight (only with roofing felt and roof shingles)
- Roof covering kit (7)
- Glazing kit white
- Wooden floor 18mm (17)
- Wooden floor 18mm impregnated (17)
- Wooden floor 26mm (22)
- Wooden floor 26mm impregnated (22)
- Additional wall layer

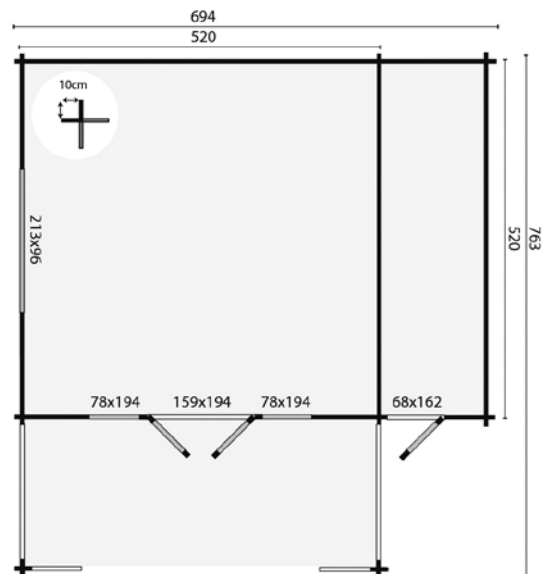

All options can be found from page 399 onwards
Wooden floor under the Porch, see page 64 and 404

27.0m ²	49.0m ²	62.0m ³	58mm	4-6-4 mm
11.4m ²				
7.8m ²				

SHEFFIELD - LOG CABIN



Optional roof shingles, straight (60m²)
 Optional roof shingles, beavertail (60m²)
 Optional roof shingles, hexagonal (60m²)

Optional roof tile profile boards (65m²)*
 Inclusief aquapan

Specifications:

Article no..... 40.7015
 Wood thickness 58mm
 Wood type spruce, untreated
 Dimensions..... 540x540+423cm
 Foundation size 520x943cm
 Ridge height approx. 263cm
 Windows 2 (fixed) / 1 (can be opened)
 Glass double glazing

Supplied with separate bars for windows and doors
 Side window can be placed to the left or to the right
 * Tip: When fitting roof tile profile boards we recommend that you also order the wide wind stops
 The colour of the gutter planks and wind stops may differ somewhat

Optional extra's

- Impregnation: Green, Brown, Silver-Grey
- Impregnating Liquid in Green, Brown, Silver-Grey or Transparent (4)
- Spray-applied base coat: White, Grey, Charcoal, Transparent
- Stain (8)
- Carefree protect (8)
- Starter's set (Nails, air vent & storm anchor set)
- Foundation beams, impregnated 300cm (12)
- Foundation beams, hardwood 300cm (12)
- Foundation beams, synthetic 300cm (12)
- Construction girders, hardwood 4.0x20.0x300cm (12)
- Hardwood stakes with point 6.0x6.0x75cm (60)
- Gutter set plastic 100mm (charcoal)
- Gutter set thermally galvanised 125mm
- Gutter plank (impr. Spruce, necessary for fitting a gutter) (6)
- Skylight (only with roofing felt and roof shingles)
- Roof covering kit (6)
- Glazing kit white
- Wooden floor 18mm (13)
- Wooden floor 18mm impregnated (13)
- Wooden floor 26mm (17)
- Wooden floor 26mm impregnated (17)
- Additional wall layer
- * Wide wind stop (impregnated spruce) (8)

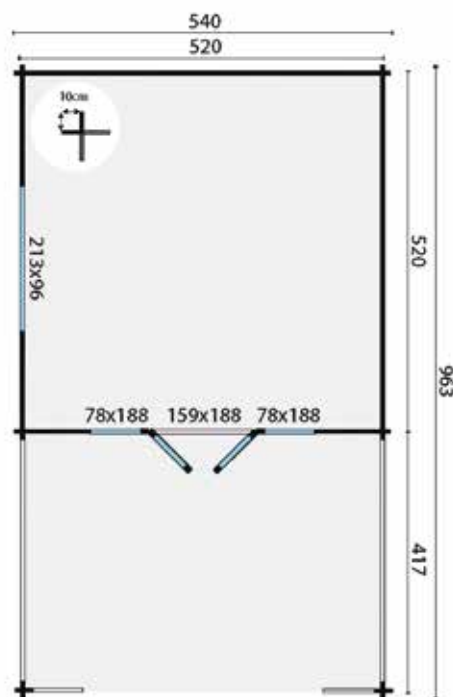

All options can be found from page 399 onwards
 Wooden floor under the Porch, see page 64 and 404

27.0m ²	41.1m ²	62.0m ³	58mm	4-6-4 4-16-4 mm
21.8m ²				

TORSTEN - LOG CABIN

Optional roof shingles, straight (42m²)
 Optional roof shingles, beavertail (42m²)
 Optional roof shingles, hexagonal (42m²)

Optional roof tile profile boards (45m²)*
 Optional aquapan

Specifications:

Article no..... 40.0812
 Wood thickness 58mm
 Wood type spruce, untreated
 Dimensions..... 595x400+195cm
 Foundation size 575x380cm
 Ridge height approx. 263cm
 Windows 3 (can be opened)
 Glass double glazing

Supplied with separate bars for windows and doors

Doors and windows can be placed to the left or to the right.

* Tip: When fitting roof tile profile boards we recommend that you also order the wide wind stops

The colour of the gutter planks and wind stops may differ somewhat

Optional extra's

Impregnation: Green, Brown, Silver-Grey
 Impregnating Liquid in Green, Brown, Silver-Grey or Transparent (4)
 Spray-applied base coat: White, Grey, Charcoal, Transparent
 Stain (8)
 Carefree protect (8)
 Starter's set (Nails, air vent & storm anchor set)
 Foundation beams, impregnated 300cm (7)
 Foundation beams, hardwood 300cm (7)
 Foundation beams, synthetic 300cm (7)
 Construction girders, hardwood 4.0x20.0x300cm (7)
 Hardwood stakes with point 6.0x6.0x75cm (35)
 Gutter set plastic 100mm (charcoal)
 Gutter set thermally galvanised 125mm
 Gutter plank (impr. Spruce, necessary for fitting a gutter) (4)
 Skylight (only with roofing felt and roof shingles)
 Roof covering kit (5)
 Glazing kit white
 Wooden floor 18mm (11)
 Wooden floor 18mm impregnated (11)
 Wooden floor 26mm (15)
 Wooden floor 26mm impregnated (15)
 Additional wall layer
 * Wide wind stop (impregnated spruce) (8)

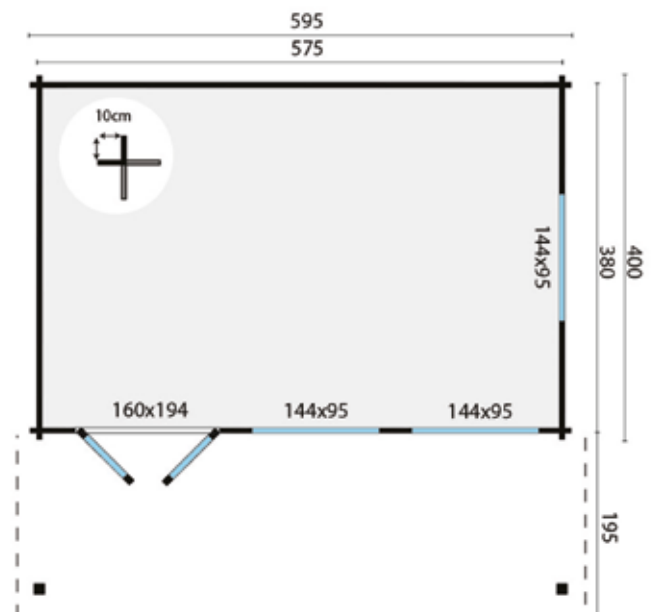

All options can be found from page 399 onwards
 Wooden floor under the Porch, see page 64 and 404

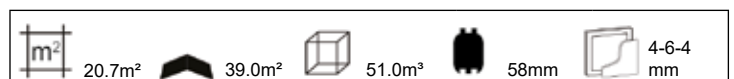

RUNE - LOG CABIN



Optional roof shingles, straight (57m²)
 Optional roof shingles, beavertail (57m²)
 Optional roof shingles, hexagonal (57m²)

Optional roof tile profile boards (53m²)*
 Optional aquapan

Specifications:

Article no..... 40.0865
 Wood thickness 70mm
 Wood type spruce, untreated
 Dimensions..... 595x595+200cm
 Foundation size 575x575cm
 Ridge height approx. 276cm
 Windows 3 (can be opened)
 Glass double glazing

Supplied with separate bars for windows and doors
 Doors and windows can be placed to the left or to the right.
 Side window can be placed to the left or to the right
 A maximum of one extra wall layer is possible for this model
 * Tip: When fitting roof tile profile boards we recommend that you also order the wide wind stops
 The colour of the gutter planks and wind stops may differ somewhat

Optional extra's

- Impregnation: Green, Brown, Silver-Grey
- Impregnating Liquid in Green, Brown, Silver-Grey or Transparent (5)
- Spray-applied base coat: White, Grey, Charcoal, Transparent
- Stain (10)
- Carefree protect (10)
- Starter's set (Nails, air vent & storm anchor set)
- Foundation beams, impregnated 300cm (8)
- Foundation beams, hardwood 300cm (8)
- Foundation beams, synthetic 300cm (8)
- Construction girders, hardwood 4.0x20.0x300cm (8)
- Hardwood stakes with point 6.0x6.0x75cm (40)
- Gutter set plastic 100mm (charcoal)
- Gutter set thermally galvanised 125mm
- Gutter plank (impr. Spruce, necessary for fitting a gutter) (4)
- Skylight (only with roofing felt and roof shingles)
- Roof covering kit (6)
- Glazing kit white
- Wooden floor 18mm (16)
- Wooden floor 18mm impregnated (16)
- Wooden floor 26mm (22)
- Wooden floor 26mm impregnated (22)
- Additional wall layer
- * Wide wind stop (impragnated spruce) (8)

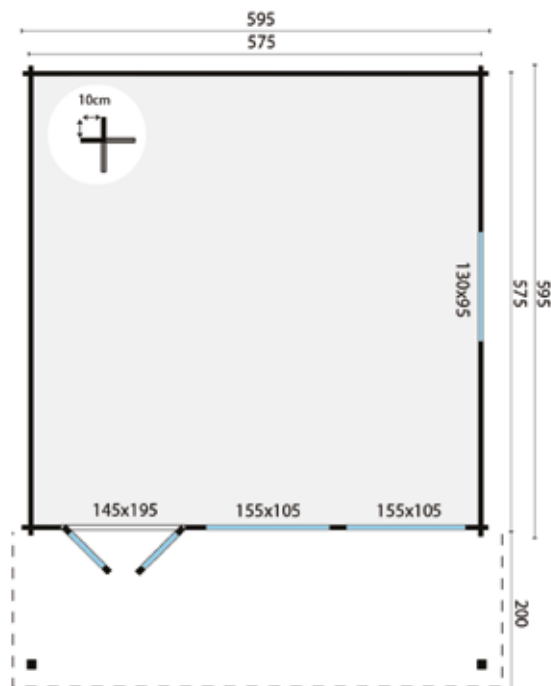

All options can be found from page 399 onwards
 Wooden floor under the Porch, see page 64 and 404

33.0m²
 50.0m²
 82.5m³
 70mm
 4-6-4 mm

EIGO - LOG CABIN



Optional roofing felt (10m²)
 Optional EASY-roofing (10m²)
 Optional EPDM (7m²)

Specifications:

Article no..... 40.0167
 Wood thickness 19mm
 Wood type spruce, untreated
 Dimensions..... 220x220cm
 Foundation size 208x208cm
 Ridge height front/back..... approx. 228/205cm
 Windows 1 (fixed)
 Glass single glazing
 Side window can be placed to the left or to the right

Optional extra's

Impregnation: Green, Brown, Silver-Grey
 Impregnating Liquid in Green, Brown, Silver-Grey or Transparent (2)
 Spray-applied base coat: White, Grey, Charcoal, Transparent
 Stain (3)
 Carefree protect (3)
 Starter's set (Nails, air vent & storm anchor set)
 Foundation beams, impregnated 300cm (3)
 Foundation beams, hardwood 300cm (3)
 Foundation beams, synthetic 300cm (3)
 Construction girders, hardwood 4.0x20.0x300cm (3)
 Hardwood stakes with point 6.0x6.0x75cm (15)
 Gutter set plastic 65mm (charcoal)
 Gutter set thermally galvanised 125mm
 Roof covering kit
 EPDM Adhesive
 Glazing kit white
 Wooden floor 18mm (2)
 Wooden floor 18mm impregnated (2)
 Wooden floor 26mm (3)
 Wooden floor 26mm impregnated (3)
 Additional wall layer
 Aluminium Edging Strip (2)
 Aluminium Outer Corner (4)

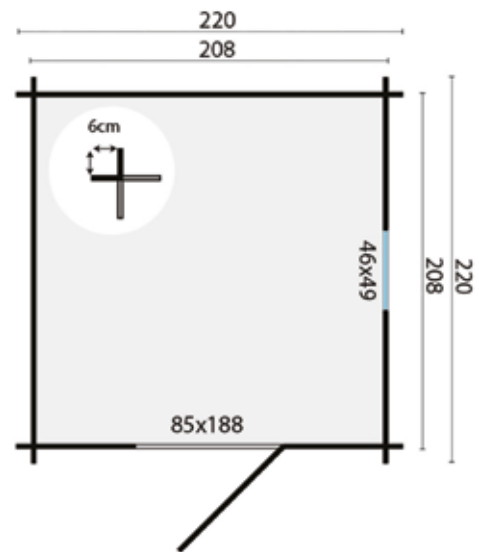

All options can be found from page 399 onwards

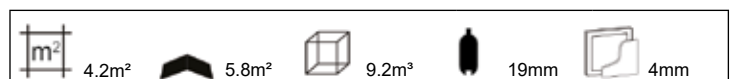

KRIS - LOG CABIN



- Optional roofing felt (10m²)
- Optional EASY-roofing (15m²)
- Optional EPDM (9m²)

Specifications:

Article no..... 40.0193
 Wood thickness 28mm
 Wood type spruce, untreated
 Dimensions..... 290x200cm
 Foundation size 270x180cm
 Ridge height front/back..... approx. 219/190cm
 Glass single glazing
 Supplied with fixed bars on doors

Optional extra's

- Impregnation: Green, Brown, Silver-Grey
- Impregnating Liquid in Green, Brown, Silver-Grey or Transparent (2)
- Spray-applied base coat: White, Grey, Charcoal, Transparent
- Stain (3)
- Carefree protect (3)
- Starter's set (Nails, air vent & storm anchor set)
- Foundation beams, impregnated 300cm (4)
- Foundation beams, hardwood 300cm (4)
- Foundation beams, synthetic 300cm (4)
- Construction girders, hardwood 4.0x20.0x300cm (4)
- Hardwood stakes with point 6.0x6.0x75cm (20)
- Gutter set plastic 65mm (charcoal)
- Gutter set plastic 100mm (charcoal)
- Gutter set thermally galvanised 125mm
- Roof covering kit (2)
- EPDM Adhesive
- Glazing kit white
- Wooden floor 18mm (3)
- Wooden floor 18mm impregnated (3)
- Wooden floor 26mm (4)
- Wooden floor 26mm impregnated (4)
- Additional wall layer
- Aluminium Edging Strip (3)
- Aluminium Outer Corner (4)

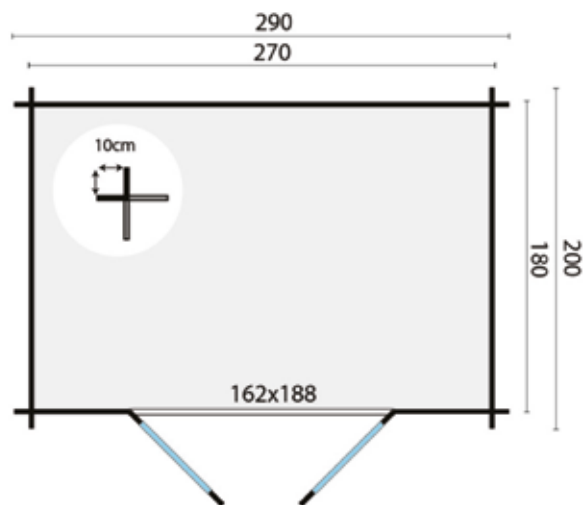

All options can be found from page 399 onwards

4.8m ²	7.0m ²	9.6m ³	28mm	4mm
-------------------	-------------------	-------------------	------	-----

MILA - LOG CABIN



Optional roofing felt (13m²)
 Optional EASY-roofing (20m²)
 Optional EPDM (11m²)

Specifications:

Article no..... 40.7059
 Wood thickness 28mm
 Wood type spruce, untreated
 Dimensions.....290x260cm
 Foundation size270x240cm
 Ridge height front/back..... approx. 222/188cm
 Glass single glazing
 Supplied with separate bars for doors

Optional extra's

Impregnation: Green
 Impregnation: Brown, Silver-Grey
 Impregnating Liquid in Green, Brown, Silver-Grey or Transparent (2)
 Spray-applied base coat: White, Grey, Charcoal, Transparent
 Stain (3)
 Carefree protect (3)
 Starter's set (Nails, air vent & storm anchor set)
 Foundation beams, impregnated 300cm (4)
 Foundation beams, hardwood 300cm (4)
 Foundation beams, synthetic 300cm (4)
 Construction girders, hardwood 4.0x20.0x300cm (4)
 Hardwood stakes with point 6.0x6.0x75cm (20)
 Gutter set plastic 65mm (charcoal)
 Gutter set plastic 100mm (charcoal)
 Gutter set thermally galvanised 125mm
 Roof covering kit (2)
 EPDM Adhesive
 Glazing kit white
 Wooden floor 18mm (4)
 Wooden floor 18mm impregnated (4)
 Wooden floor 26mm (5)
 Wooden floor 26mm impregnated (5)
 Additional wall layer
 Aluminium Edging Strip (4)
 Aluminium Outer Corner (4)

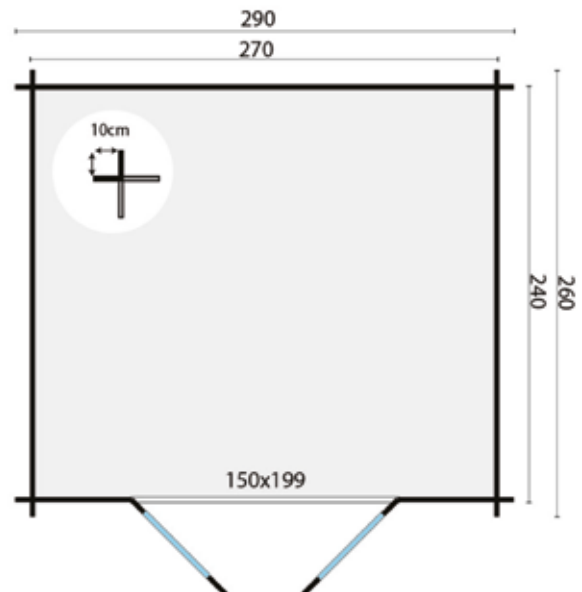

All options can be found from page 399 onwards



JÖRGEN - LOG CABIN



- Optional roofing felt (13m²)
- Optional EASY-roofing (20m²)
- Optional EPDM (12m²)

Specifications:

Article no..... 40.0196
 Wood thickness 28mm
 Wood type spruce, untreated
 Dimensions.....290x290cm
 Foundation size270x270cm
 Ridge height front/back..... approx. 219/190cm
 Glass single glazing
 Supplied with fixed bars on doors

Optional extra's

- Impregnation: Green
- Impregnation: Brown, Silver-Grey
- Impregnating Liquid in Green, Brown, Silver-Grey or Transparent (2)
- Spray-applied base coat: White, Grey, Charcoal, Transparent
- Stain (4)
- Carefree protect (4)
- Starter's set (Nails, air vent & storm anchor set)
- Foundation beams, impregnated 300cm (4)
- Foundation beams, hardwood 300cm (4)
- Foundation beams, synthetic 300cm (4)
- Construction girders, hardwood 4.0x20.0x300cm (4)
- Hardwood stakes with point 6.0x6.0x75cm (20)
- Gutter set plastic 65mm (charcoal)
- Gutter set plastic 100mm (charcoal)
- Gutter set thermally galvanised 125mm
- Roof covering kit (2)
- EPDM Adhesive
- Glazing kit white
- Wooden floor 18mm (4)
- Wooden floor 18mm impregnated (4)
- Wooden floor 26mm (5)
- Wooden floor 26mm impregnated (5)
- Additional wall layer
- Aluminium Edging Strip (4)
- Aluminium Outer Corner (4)

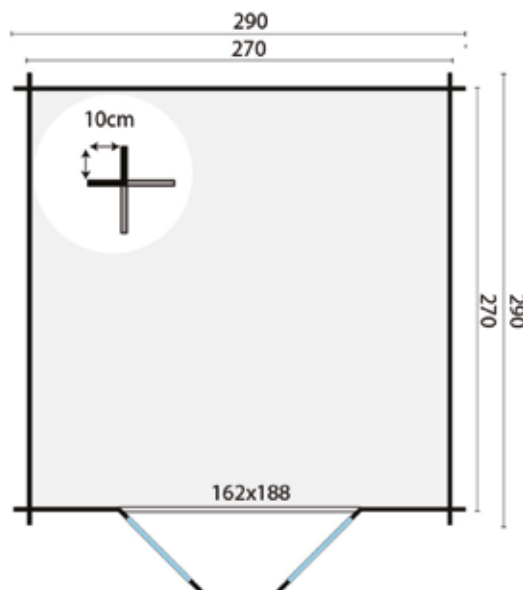

All options can be found from page 399 onwards

7.3m ²	9.6m ²	14.6m ³	28mm	4mm
-------------------	-------------------	--------------------	------	-----

LOYA - LOG CABIN



Optional roofing felt (20m²)
 Optional EASY-roofing (20m²)
 Optional EPDM (17m²)

Specifications:

Article no..... 40.7264
 Wood thickness 28mm
 Wood type spruce, untreated
 Dimensions..... 380x300cm
 Foundation size 360x280cm
 Ridge height approx. 220/188cm
 Windows 1 (can be opened)
 Glass single glazing
 Supplied with fixed bars for windows and doors
 Side window can be placed to the left or to the right

Optional extra's

Impregnation: Green, Brown, Silver-Grey
 Impregnating Liquid in Green, Brown, Silver-Grey or Transparent (2)
 Spray-applied base coat: White, Grey, Charcoal, Transparent
 Stain (4)
 Carefree protect (4)
 Starter's set (Nails, air vent & storm anchor set)
 Foundation beams, impregnated 300cm (5)
 Foundation beams, hardwood 300cm (5)
 Foundation beams, synthetic 300cm (5)
 Construction girders, hardwood 4.0x20.0x300cm (5)
 Hardwood stakes with point 6.0x6.0x75cm (25)
 Gutter set plastic 65mm (charcoal)
 Gutter set plastic 100mm (charcoal)
 Gutter set thermally galvanised 125mm
 Roof covering kit (3)
 EPDM Adhesive
 Glazing kit white
 Wooden floor 18mm (6)
 Wooden floor 18mm impregnated (6)
 Wooden floor 26mm (8)
 Wooden floor 26mm impregnated (8)
 Additional wall layer
 Aluminium Edging Strip (5)
 Aluminium Outer Corner (4)

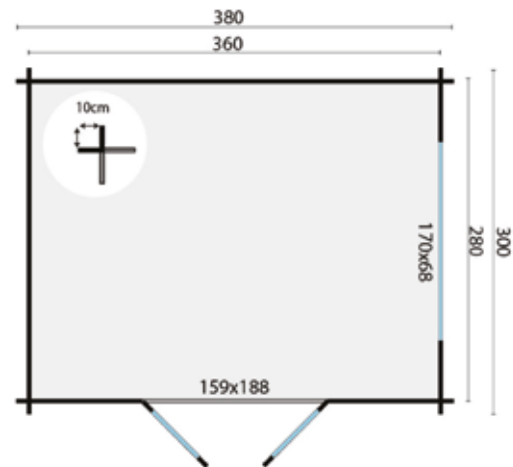

All options can be found from page 399 onwards

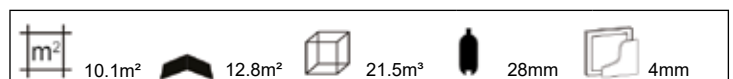

FREDDY - LOG CABIN



Optional roofing felt (19.5m²)
 Optional EASY-roofing (20m²)
 Optional EPDM (19m²)

Specifications:

- Article no..... 40.0195
- Wood thickness 28mm
- Wood type green impregnated spruce
- Dimensions..... 300+298x250cm
- Foundation size 578x230cm
- Ridge height front/back..... approx. 217/190cm
- Glass single glazing
- Supplied with separate bars for doors
- Can also be constructed in mirror image

Optional extra's

- Standard green impregnated
- Stain (4)
- Carefree protect (4)
- Starter's set (Nails, air vent & storm anchor set)
- Foundation beams, impregnated 300cm (5)
- Foundation beams, hardwood 300cm (5)
- Foundation beams, synthetic 300cm (5)
- Construction girders, hardwood 4.0x20.0x300cm (5)
- Hardwood stakes with point 6.0x6.0x75cm (25)
- Gutter set plastic 100mm (charcoal)
- Gutter set thermally galvanised 125mm
- Roof covering kit (3)
- EPDM Adhesive
- Glazing kit white
- Wooden floor 18mm (3)
- Wooden floor 18mm impregnated (3)
- Wooden floor 26mm (4)
- Wooden floor 26mm impregnated (4)
- Additional wall layer
- Aluminium Edging Strip (6)
- Aluminium Outer Corner (4)

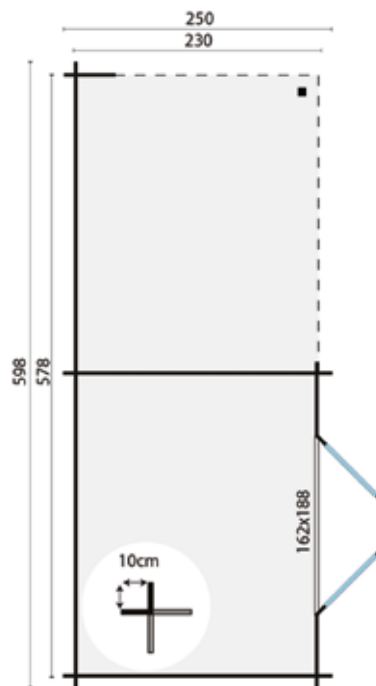

All options can be found from page 399 onwards
 Wooden floor under the Porch, see page 64 and 404

6.4m ²	16.5m ²	12.8m ³	28mm	4mm
-------------------	--------------------	--------------------	------	-----

DORA - LOG CABIN

Optional roofing felt (26.5m²)
 Optional EASY-roofing (25m²)
 Optional EPDM (20m²)

Specifications:

Article no..... 40.0197
 Wood thickness 28mm
 Wood type green impregnated spruce
 Dimensions..... 300+200x300cm
 Foundation size 480x280cm
 Ridge height front/back..... approx. 217/190cm
 Glass single glazing
 Supplied with separate bars for doors
 Can also be constructed in mirror image

Optional extra's

Standard green impregnated
 Stain (5)
 Carefree protect (5)
 Starter's set (Nails, air vent & storm anchor set)
 Foundation beams, impregnated 300cm (5)
 Foundation beams, hardwood 300cm (5)
 Foundation beams, synthetic 300cm (5)
 Construction girders, hardwood 4.0x20.0x300cm (5)
 Hardwood stakes with point 6.0x6.0x75cm (25)
 Gutter set plastic 100mm (charcoal)
 Gutter set thermally galvanised 125mm
 Roof covering kit (3)
 EPDM Adhesive
 Glazing kit white
 Wooden floor 18mm (4)
 Wooden floor 18mm impregnated (4)
 Wooden floor 26mm (5)
 Wooden floor 26mm impregnated (5)
 Additional wall layer
 Aluminium Edging Strip (6)
 Aluminium Outer Corner (4)

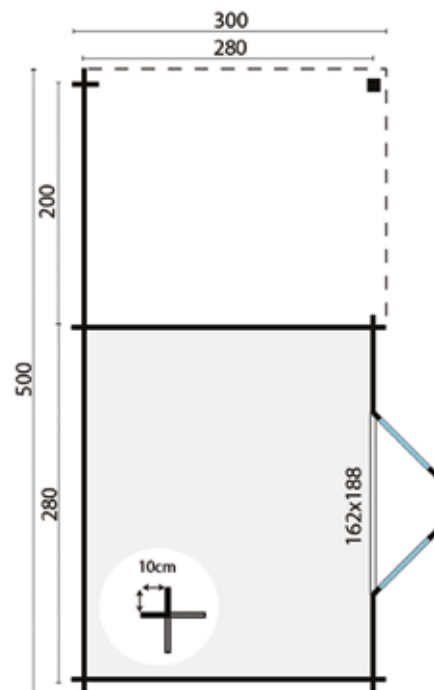

All options can be found from page 399 onwards
 Wooden floor under the Porch, see page 64 and 404

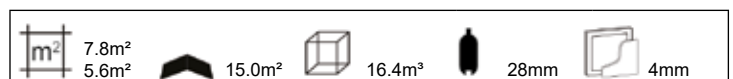

CHAPPO - LOG CABIN



Optional roofing felt (26m²)
 Optional EASY-roofing (25m²)
 Optional EPDM (23m²)

Specifications:

Article no..... 40.0194
 Wood thickness 28mm
 Wood type green impregnated spruce
 Dimensions..... 300+298x300cm
 Foundation size 578x280cm
 Ridge height front/back..... approx. 217/190cm
 Glass single glazing
 Supplied with separate bars for doors
 Can also be constructed in mirror image

Optional extra's

Standard green impregnated
 Stain (5)
 Carefree protect (5)
 Starter's set (Nails, air vent & storm anchor set)
 Foundation beams, impregnated 300cm (5)
 Foundation beams, hardwood 300cm (5)
 Foundation beams, synthetic 300cm (5)
 Construction girders, hardwood 4.0x20.0x300cm (5)
 Hardwood stakes with point 6.0x6.0x75cm (25)
 Gutter set plastic 100mm (charcoal)
 Gutter set thermally galvanised 125mm
 Roof covering kit (3)
 EPDM Adhesive
 Glazing kit white
 Wooden floor 18mm (4)
 Wooden floor 18mm impregnated (4)
 Wooden floor 26mm (5)
 Wooden floor 26mm impregnated (5)
 Additional wall layer
 Aluminium Edging Strip (6)
 Aluminium Outer Corner (4)

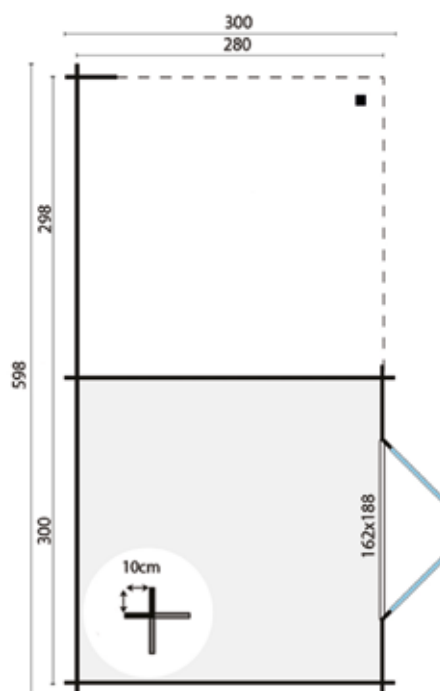

All options can be found from page 399 onwards
 Wooden floor under the Porch, see page 64 and 404

7.8m ²	19.5m ²	15.6m ³	28mm	4mm
7.8m ²				

CHARLOTTA - LOG CABIN

Optional roofing felt (40m²)
 Optional EASY-roofing (30m²)
 Optional EPDM (27m²)

Specifications:

Article no..... 40.0198
 Wood thickness 28mm
 Wood type green impregnated spruce
 Dimensions..... 300+400x300cm
 Foundation size 680x280cm
 Ridge height front/back..... approx. 217/190cm
 Glass single glazing
 Supplied with separate bars for doors
 Can also be constructed in mirror image

Optional extra's

Standard green impregnated
 Stain (5)
 Carefree protect (5)
 Starter's set (Nails, air vent & storm anchor set)
 Foundation beams, impregnated 300cm (6)
 Foundation beams, hardwood 300cm (6)
 Foundation beams, synthetic 300cm (6)
 Construction girders, hardwood 4.0x20.0x300cm (6)
 Hardwood stakes with point 6.0x6.0x75cm (30)
 Gutter set plastic 100mm (charcoal)
 Gutter set thermally galvanised 125mm
 Roof covering kit (4)
 EPDM Adhesive
 Glazing kit white
 Wooden floor 18mm (4)
 Wooden floor 18mm impregnated (4)
 Wooden floor 26mm (5)
 Wooden floor 26mm impregnated (5)
 Additional wall layer
 Aluminium Edging Strip (7)
 Aluminium Outer Corner (4)

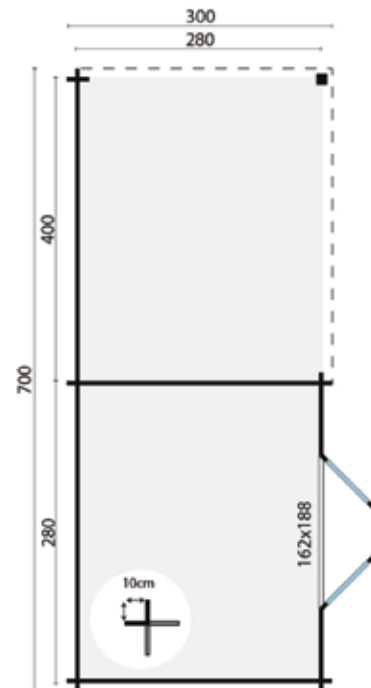

All options can be found from page 399 onwards
 Wooden floor under the Porch, see page 64 and 404

	7.8m ²		22.8m ²		16.9m ³		28mm		4mm
--	-------------------	--	--------------------	--	--------------------	--	------	--	-----

ANTON - LOG CABIN



Optional roofing felt (50m²)
 Optional EASY-roofing (35m²)
 Optional EPDM (35m²)

Specifications:

Article no..... 40.0199
 Wood thickness 40mm
 Wood type green impregnated spruce
 Dimensions..... 300+400x400cm
 Foundation size 680x380cm
 Ridge height approx. 217cm
 Windows 1 (fixed)
 Glass single-glazed

Supplied with separate bars for windows and doors
 Can also be constructed in mirror image
 Side window can be placed to the left or to the right

Optional extra's

- Standard green impregnated
- Stain (5)
- Carefree protect (5)
- Starter's set (Nails, air vent & storm anchor set)
- Foundation beams, impregnated 300cm (7)
- Foundation beams, hardwood 300cm (7)
- Foundation beams, synthetic 300cm (7)
- Construction girders, hardwood 4.0x20.0x300cm (7)
- Hardwood stakes with point 6.0x6.0x75cm (35)
- Gutter set plastic 100mm (charcoal)
- Gutter set thermally galvanised 125mm
- Roof covering kit (5)
- EPDM Adhesive
- Glazing kit white
- Wooden floor 18mm (5)
- Wooden floor 18mm impregnated (5)
- Wooden floor 26mm (7)
- Wooden floor 26mm impregnated (7)
- Additional wall layer
- Aluminium Edging Strip (9)
- Aluminium Outer Corner (4)

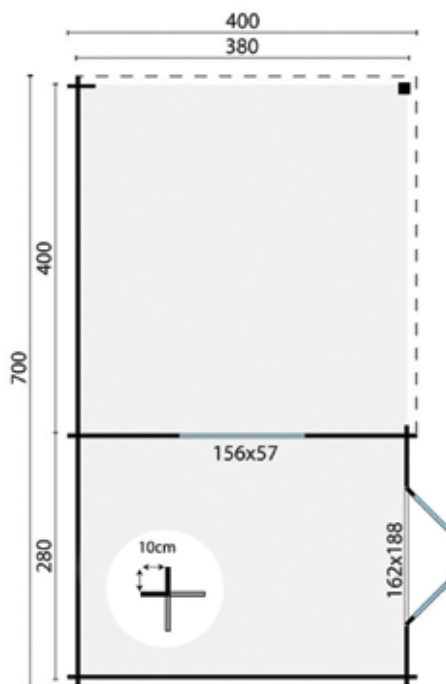

All options can be found from page 399 onwards
 Wooden floor under the Porch, see page 64 and 404

10.6m ²	28.0m ²	23.0m ³	40mm	4mm
15.2m ²				

NOVALIE - LOG CABIN

Optional roofing felt (10m²)
 Optional EASY-roofing (15m²)
 Optional EPDM (11m²)

Specifications:

Article no..... 40.0164
 Wood thickness 19mm
 Wood type spruce, untreated
 Dimensions..... 300x200cm
 Foundation size 288x188cm
 Ridge height approx. 239cm
 Glass single glazing
 Wooden floor included
 Can also be constructed in mirror image

Optional extra's

Impregnation: Green, Brown, Silver-Grey
 Impregnating Liquid in Green, Brown, Silver-Grey or Transparent (2)
 Spray-applied base coat: White, Grey, Charcoal, Transparent
 Stain (3)
 Carefree protect (3)
 Starter's set (Nails, air vent & storm anchor set)
 Foundation beams, impregnated 300cm (4)
 Foundation beams, hardwood 300cm (4)
 Foundation beams, synthetic 300cm (4)
 Construction girders, hardwood 4.0x20.0x300cm (4)
 Hardwood stakes with point 6.0x6.0x75cm (20)
 Gutter set plastic 65mm (charcoal)
 Gutter set plastic 100mm (charcoal)
 Gutter set thermally galvanised 125mm
 Roof covering kit (3)
 EPDM Adhesive
 Glazing kit white
 Additional wall layer
 Aluminium Edging Strip (3)
 Aluminium Outer Corner (4)
 Roof Duct, Round

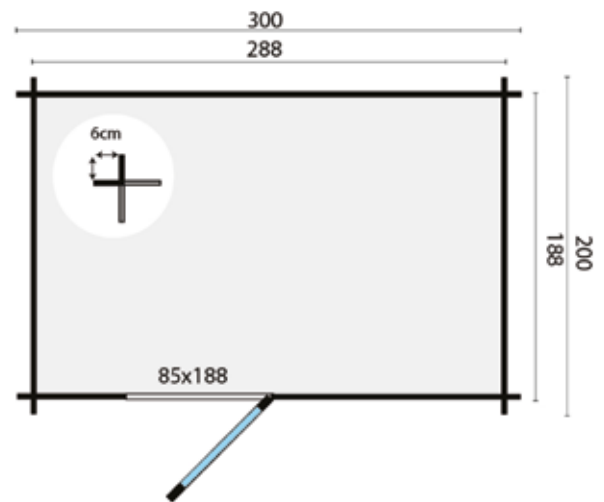

All options can be found from page 399 onwards

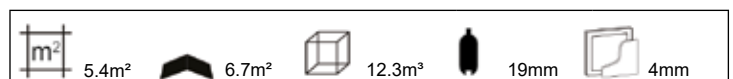

MINIMODERN - LOG CABIN

Optional roofing felt (16.5m²)
 Optional EASY-roofing (15m²)
 Optional EPDM (10m²)

Specifications:

Article no..... 40.0790
 Wood thickness 28mm
 Wood type spruce, untreated
 Dimensions..... 300x200cm
 Foundation size 290x190cm
 Ridge height approx. 230cm
 Glass single glazing

Optional extra's

Impregnation: Green, Brown, Silver-Grey
 Impregnating Liquid in Green, Brown, Silver-Grey or Transparent (2)
 Spray-applied base coat: White, Grey, Charcoal, Transparent
 Stain (3)
 Carefree protect (3)
 Starter's set (Nails, air vent & storm anchor set)
 Foundation beams, impregnated 300cm (4)
 Foundation beams, hardwood 300cm (4)
 Foundation beams, synthetic 300cm (4)
 Construction girders, hardwood 4.0x20.0x300cm (4)
 Hardwood stakes with point 6.0x6.0x75cm (20)
 Gutter set plastic 65mm (charcoal)
 Gutter set plastic 100mm (charcoal)
 Gutter set thermally galvanised 125mm
 Roof covering kit (2)
 EPDM Adhesive
 Glazing kit white
 Wooden floor 18mm (3)
 Wooden floor 18mm impregnated (3)
 Wooden floor 26mm (4)
 Wooden floor 26mm impregnated (4)
 Additional wall layer
 Aluminium Edging Strip (3)
 Aluminium Outer Corner (4)
 Roof Duct, Round

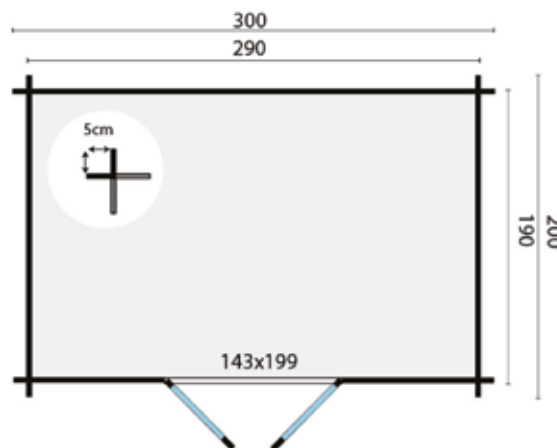

All options can be found from page 399 onwards



BODINE - LOG CABIN

Optional roofing felt (16.5m²)
 Optional EASY-roofing (20m²)
 Optional EPDM (14m²)

Specifications:

Article no..... 40.0745
 Wood thickness 28mm
 Wood type spruce, untreated
 Dimensions.....298x298cm
 Foundation size280x280cm
 Ridge height approx. 225cm
 Windows 1 (fixed)
 Glass single glazing
 Side window can be placed to the left or to the right

Optional extra's

Impregnation: Green, Brown, Silver-Grey
 Impregnating Liquid in Green, Brown, Silver-Grey or Transparent (2)
 Spray-applied base coat: White, Grey, Charcoal, Transparent
 Stain (4)
 Carefree protect (4)
 Starter's set (Nails, air vent & storm anchor set)
 Foundation beams, impregnated 300cm (4)
 Foundation beams, hardwood 300cm (4)
 Foundation beams, synthetic 300cm (4)
 Construction girders, hardwood 4.0x20.0x300cm (4)
 Hardwood stakes with point 6.0x6.0x75cm (20)
 Gutter set plastic 65mm (charcoal)
 Gutter set plastic 100mm (charcoal)
 Gutter set thermally galvanised 125mm
 Roof covering kit (2)
 EPDM Adhesive
 Glazing kit white
 Wooden floor 18mm (4)
 Wooden floor 18mm impregnated (4)
 Wooden floor 26mm (5)
 Wooden floor 26mm impregnated (5)
 Additional wall layer
 Aluminium Edging Strip (4)
 Aluminium Outer Corner (4)
 Roof Duct, Round

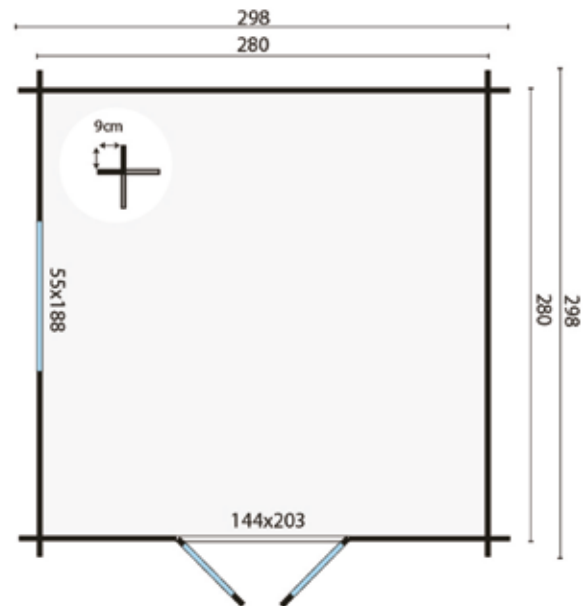

All options can be found from page 399 onwards

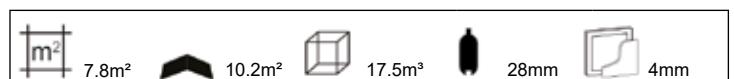

ULTRAMODERN - LOG CABIN

Optional roofing felt (16.5m²)
 Optional EASY-roofing (20m²)
 Optional EPDM (13m²)

Specifications:

Article no..... 40.0776
 Wood thickness 28mm
 Wood type spruce, untreated
 Dimensions..... 320x260cm
 Foundation size 310x250cm
 Ridge height approx. 230cm
 Windows 1 (can be opened)
 Glass single glazing
 Doors and windows can be placed to the left or to the right.

Optional extra's

Impregnation: Green, Brown, Silver-Grey
 Impregnating Liquid in Green, Brown, Silver-Grey or Transparent (2)
 Spray-applied base coat: White, Grey, Charcoal, Transparent
 Stain (4)
 Carefree protect (4)
 Starter's set (Nails, air vent & storm anchor set)
 Foundation beams, impregnated 300cm (4)
 Foundation beams, hardwood 300cm (4)
 Foundation beams, synthetic 300cm (4)
 Construction girders, hardwood 4.0x20.0x300cm (4)
 Hardwood stakes with point 6.0x6.0x75cm (20)
 Gutter set plastic 65mm (charcoal)
 Gutter set plastic 100mm (charcoal)
 Gutter set thermally galvanised 125mm
 Roof covering kit (2)
 EPDM Adhesive
 Glazing kit white
 Wooden floor 18mm (4)
 Wooden floor 18mm impregnated (4)
 Wooden floor 26mm (5)
 Wooden floor 26mm impregnated (5)
 Additional wall layer
 Aluminium Edging Strip (4)
 Aluminium Outer Corner (4)
 Roof Duct, Round

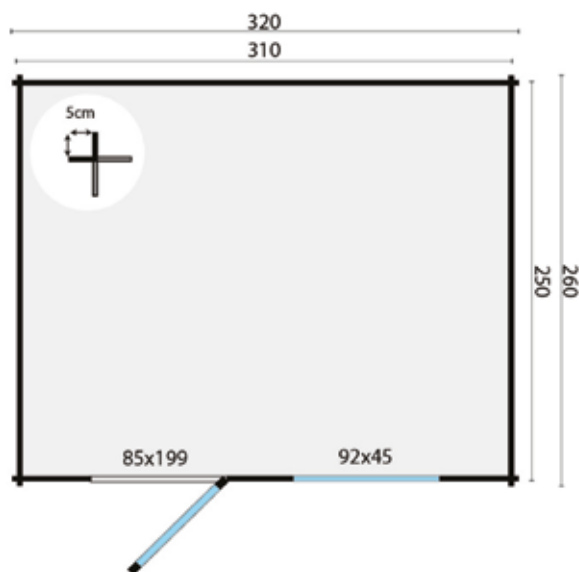

All options can be found from page 399 onwards



HYPERMODERN - LOG CABIN

Optional roofing felt (16.5m²)
 Optional EASY-roofing (20m²)
 Optional EPDM (13m²)

Specifications:

Article no..... 40.0777
 Wood thickness 28mm
 Wood type spruce, untreated
 Dimensions..... 320x260cm
 Foundation size 310x250cm
 Ridge height approx. 230cm
 Glass single glazing

Optional extra's

Impregnation: Green, Brown, Silver-Grey
 Impregnating Liquid in Green, Brown, Silver-Grey or Transparent (2)
 Spray-applied base coat: White, Grey, Charcoal, Transparent
 Stain (4)
 Carefree protect (4)
 Starter's set (Nails, air vent & storm anchor set)
 Foundation beams, impregnated 300cm (4)
 Foundation beams, hardwood 300cm (4)
 Foundation beams, synthetic 300cm (4)
 Construction girders, hardwood 4.0x20.0x300cm (4)
 Hardwood stakes with point 6.0x6.0x75cm (20)
 Gutter set plastic 65mm (charcoal)
 Gutter set plastic 100mm (charcoal)
 Gutter set thermally galvanised 125mm
 Roof covering kit (2)
 EPDM Adhesive
 Glazing kit white
 Wooden floor 18mm (4)
 Wooden floor 18mm impregnated (4)
 Wooden floor 26mm (5)
 Wooden floor 26mm impregnated (5)
 Additional wall layer
 Aluminium Edging Strip (4)
 Aluminium Outer Corner (4)
 Roof Duct, Round

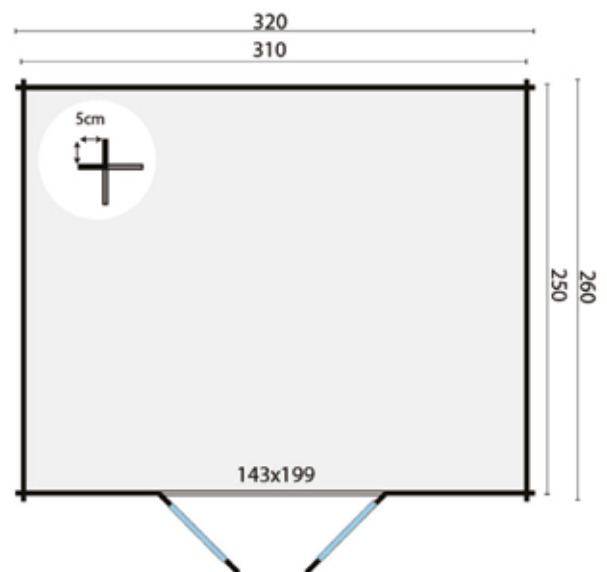

All options can be found from page 399 onwards

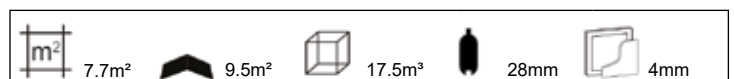

ELIN - LOG CABIN



Optional EASY-roofing (25m²)
Optional EPDM (21m²)

Specifications:

Article no..... 40.0817
Wood thickness 19mm
Wood type spruce, untreated
Dimensions.....477x351cm
Foundation size477x351cm
Ridge height approx. 265cm
Covering double-walled
Windows 5 (fixed)
Glass double glazing
Wooden floor included

This garden house is ideal for insulating.
The floor, roof and the walls are double-walled.

Optional extra's

- Spray-applied base coat: White, Grey, Charcoal, Transparent
- Stain (6)
- Carefree protect (6)
- Starter's set (Nails, air vent & storm anchor set)
- EPDM Adhesive
- Glazing kit white
- Aluminium Edging Strip (6)
- Aluminium Outer Corner (4)
- square urban grommet included

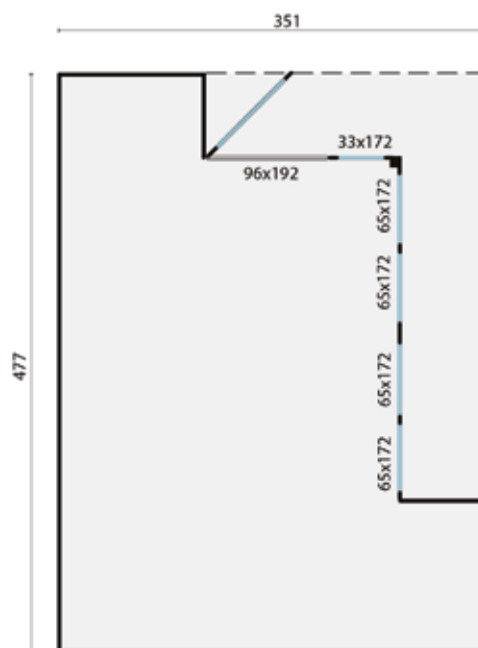

All options can be found from page 399 onwards

13.3m ² 3.4m ²	17.1m ²	35.2m ³	19mm	3-6-3 mm
---	--------------------	--------------------	------	----------

LORY - LOG CABIN



Optional EASY-roofing (30m²)
Optional EPDM (34m²)

Specifications:

Article no..... 40.0802
Wood thickness 44mm
Wood type spruce, untreated
Dimensions..... 435x350+120cm
Foundation size 415x330cm
Ridge height approx. 230cm
Windows 2 (fixed) / 2 (can be opened)
Glass double glazing

Optional extra's

Impregnation: Green, Brown, Silver-Grey
Impregnating Liquid in Green, Brown, Silver-Grey or Transparent (2)
Spray-applied base coat: White, Grey, Charcoal, Transparent
Stain (4)
Carefree protect (4)
Starter's set (Nails, air vent & storm anchor set)
Foundation beams, impregnated 300cm (6)
Foundation beams, hardwood 300cm (6)
Foundation beams, synthetic 300cm (6)
Construction girders, hardwood 4.0x20.0x300cm (6)
Hardwood stakes with point 6.0x6.0x75cm (30)
EPDM Adhesive
Glazing kit white
Wooden floor 18mm (7)
Wooden floor 18mm impregnated (7)
Wooden floor 26mm (9)
Wooden floor 26mm impregnated (9)
Aluminium Edging Strip (7)
Aluminium Outer Corner (4)
Roof Duct, Round

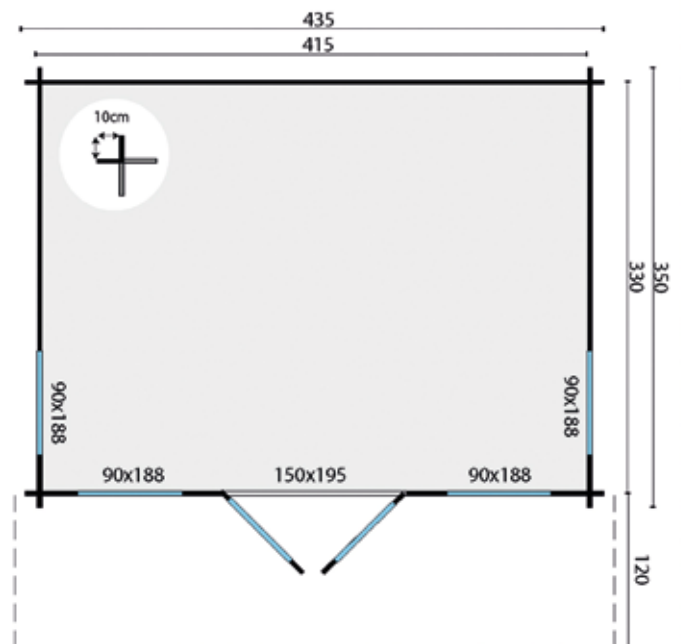

All options can be found from page 399 onwards



YORICK - LOG CABIN

Optional EASY-roofing (35m²)
Optional EPDM (34m²)

Specifications:

Article no..... 40.0810
Wood thickness 44mm
Wood type spruce, untreated
Dimensions..... 500x380+120cm
Foundation size 480x360cm
Ridge height approx. 230cm
Windows 2 (fixed), 2 (can be opened)
Glass tempered double glazing

Optional extra's

Impregnation: Green, Brown, Silver-Grey
Impregnating Liquid in Green, Brown, Silver-Grey or Transparent (3)
Spray-applied base coat: White, Grey, Charcoal, Transparent
Stain (5)
Carefree protect (5)
Starter's set (Nails, air vent & storm anchor set)
Foundation beams, impregnated 300cm (6)
Foundation beams, hardwood 300cm (6)
Foundation beams, synthetic 300cm (6)
Construction girders, hardwood 4.0x20.0x300cm (6)
Hardwood stakes with point 6.0x6.0x75cm (30)
EPDM Adhesive
Glazing kit white
Wooden floor 18mm (9)
Wooden floor 18mm impregnated (9)
Wooden floor 26mm (11)
Wooden floor 26mm impregnated (11)
Aluminium Edging Strip (8)
Aluminium Outer Corner (4)
Roof Duct, Round

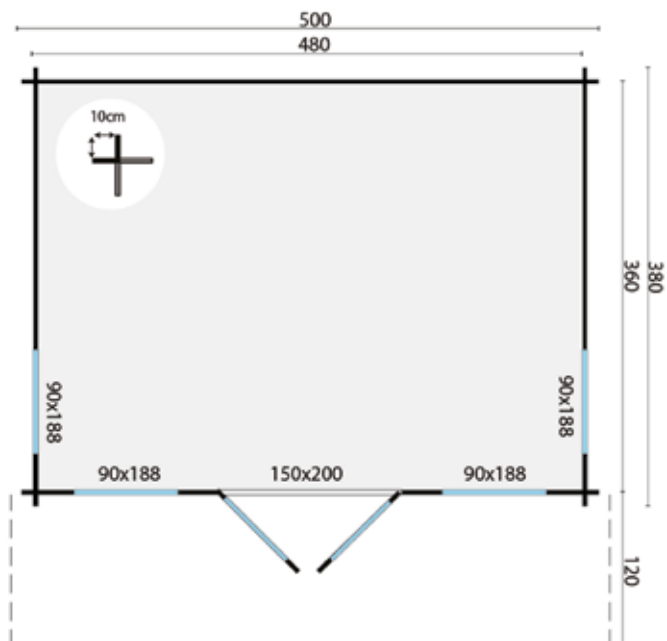

All options can be found from page 399 onwards

ANNABEL - LOG CABIN



Optional EASY-roofing (30m²)
Optional EPDM (27m²)

Specifications:

Article no..... 40.0755
Wood thickness 40mm
Wood type spruce, untreated
Dimensions..... 500x400cm
Foundation size 480x380cm
Ridge height approx. 223cm
Windows 2 (fixed)
Glass tempered double glazing
Doors and windows can be placed to the left or to the right.

Optional extra's

Impregnation: Green, Brown, Silver-Grey
Impregnating Liquid in Green, Brown, Silver-Grey or Transparent (3)
Spray-applied base coat: White, Grey, Charcoal, Transparent
Stain (6)
Carefree protect (6)
Starter's set (Nails, air vent & storm anchor set)
Foundation beams, impregnated 300cm (7)
Foundation beams, hardwood 300cm (7)
Foundation beams, synthetic 300cm (7)
Construction girders, hardwood 4.0x20.0x300cm (7)
Hardwood stakes with point 6.0x6.0x75cm (35)
EPDM Adhesive
Glazing kit white
Wooden floor 18mm (9)
Wooden floor 18mm impregnated (9)
Wooden floor 26mm (12)
Wooden floor 26mm impregnated (12)
Additional wall layer
Aluminium Edging Strip (6)
Aluminium Outer Corner (4)
Roof Duct, Round included

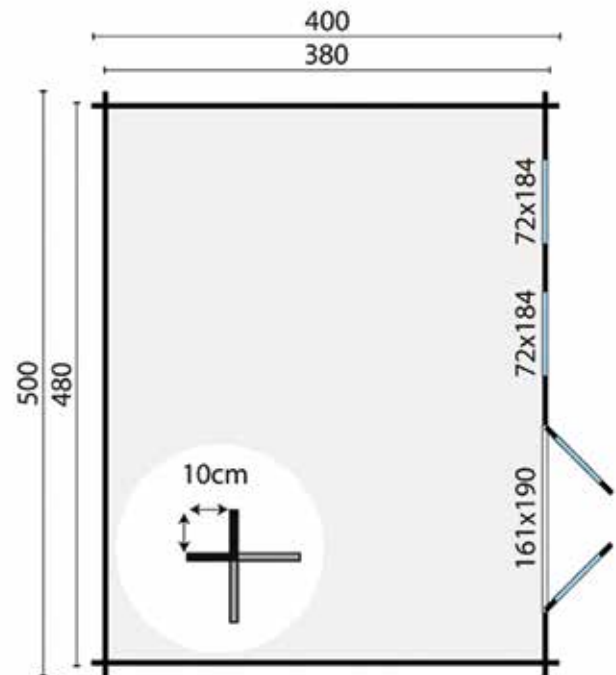

All options can be found from page 399 onwards

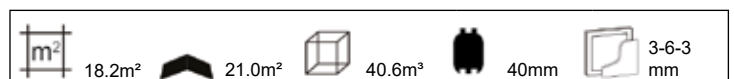

FLOW - LOG CABIN

Optional EASY-roofing (35m²)
Optional EPDM (34m²)

Specifications:

Article no..... 40.0759
Wood thickness 40mm
Wood type spruce, untreated
Dimensions..... 396+199x400cm
Foundation size 575x380cm
Ridge height approx. 230cm
Windows 1 (fixed) / 1 (can be opened)
Glass tempered double glazing
Can also be constructed in mirror image.

Optional extra's

Impregnation: Green, Brown, Silver-Grey
Impregnating Liquid in Green, Brown, Silver-Grey or Transparent (4)
Spray-applied base coat: White, Grey, Charcoal, Transparent
Stain (7)
Carefree protect (7)
Starter's set (Nails, air vent & storm anchor set)
Foundation beams, impregnated 300cm (9)
Foundation beams, hardwood 300cm (9)
Foundation beams, synthetic 300cm (9)
Construction girders, hardwood 4.0x20.0x300cm (9)
Hardwood stakes with point 6.0x6.0x75cm (45)
EPDM Adhesive
Glazing kit white
Wooden floor 18mm (11)
Wooden floor 18mm impregnated (11)
Wooden floor 26mm (14)
Wooden floor 26mm impregnated (14)
Additional wall layer
Aluminium Edging Strip (8)
Aluminium Outer Corner (4)
Roof Duct, Round included

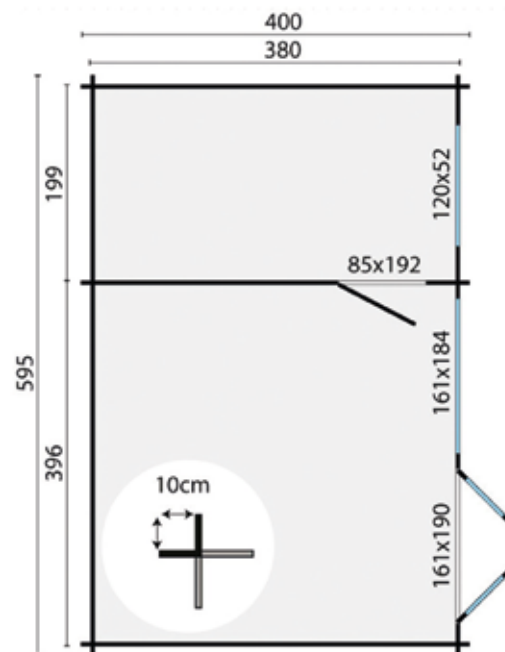

All options can be found from page 399 onwards

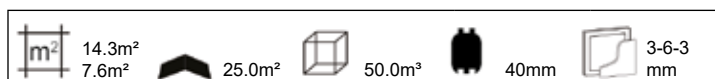

MIDDELMODERN - LOG CABIN



Optional roofing felt (19.5m²)
 Optional EASY-roofing (20m²)
 Optional EPDM (15m²)

Specifications:

Article no..... 40.0792
 Wood thickness 28mm
 Wood type spruce, untreated
 Dimensions..... 300+200x200cm
 Foundation size 290x190cm
 Ridge height approx. 230cm
 Glass single glazing
 Can also be constructed in mirror image

Optional extra's

Impregnation: Green, Brown, Silver-Grey
 Impregnating Liquid in Green, Brown, Silver-Grey or Transparent (2)
 Spray-applied base coat: White, Grey, Charcoal, Transparent
 Stain (3)
 Carefree protect (3)
 Starter's set (Nails, air vent & storm anchor set)
 Foundation beams, impregnated 300cm (4)
 Foundation beams, hardwood 300cm (4)
 Foundation beams, synthetic 300cm (4)
 Construction girders, hardwood 4.0x20.0x300cm (4)
 Hardwood stakes with point 6.0x6.0x75cm (20)
 Gutter set plastic 65mm (charcoal)
 Gutter set plastic 100mm (charcoal)
 Gutter set thermally galvanised 125mm
 Roof covering kit (3)
 EPDM Adhesive
 Glazing kit white
 Wooden floor 18mm (3)
 Wooden floor 18mm impregnated (3)
 Wooden floor 26mm (4)
 Wooden floor 26mm impregnated (4)
 Additional wall layer
 Aluminium Edging Strip (6)
 Aluminium Outer Corner (4)
 Roof Duct, Round

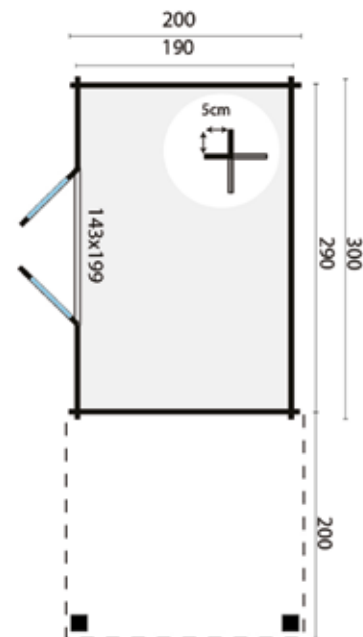

All options can be found from page 399 onwards
 Wooden floor under the Porch, see page 64 and 404



DELLINGER - LOG CABIN

Optional roofing felt (26m²)
 Optional EASY-roofing (30m²)
 Optional EPDM (25m²)

Specifications:

Article no..... 40.0746
 Wood thickness 28mm
 Wood type spruce, untreated
 Dimensions..... 298+300x298cm
 Foundation size 280x280cm
 Ridge height approx. 225cm
 Windows 1 (fixed)
 Glass single glazing

Can also be constructed in mirror image

Side window can be placed to the left or to the right

Optional extra's

Impregnation: Green, Brown, Silver-Grey
 Impregnating Liquid in Green, Brown, Silver-Grey or Transparent (3)
 Spray-applied base coat: White, Grey, Charcoal, Transparent
 Stain (5)
 Carefree protect (5)
 Starter's set (Nails, air vent & storm anchor set)
 Foundation beams, impregnated 300cm (4)
 Foundation beams, hardwood 300cm (4)
 Foundation beams, synthetic 300cm (4)
 Construction girders, hardwood 4.0x20.0x300cm (4)
 Hardwood stakes with point 6.0x6.0x75cm (20)
 Gutter set plastic 100mm (charcoal)
 Gutter set thermally galvanised 125mm
 Roof covering kit (4)
 EPDM Adhesive
 Glazing kit white
 Wooden floor 18mm (4)
 Wooden floor 18mm impregnated (4)
 Wooden floor 26mm (5)
 Wooden floor 26mm impregnated (5)
 Additional wall layer
 Aluminium Edging Strip (7)
 Aluminium Outer Corner (4)
 Roof Duct, Round

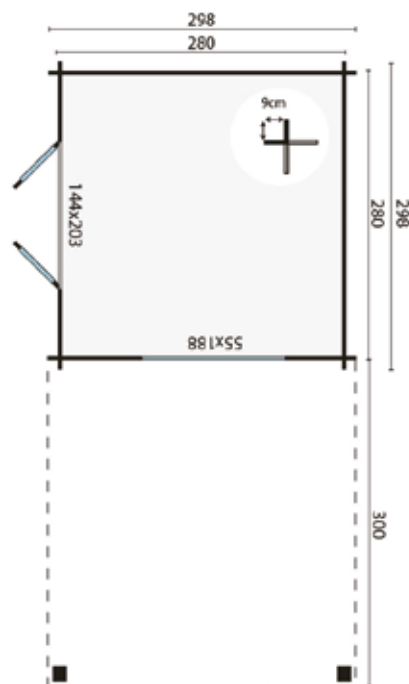

All options can be found from page 399 onwards
 Wooden floor under the Porch, see page 64 and 404



EXTRAMODERN - LOG CABIN

Optional roofing felt (26m²)
 Optional EASY-roofing (25m²)
 Optional EPDM (19m²)

Specifications:

Article no..... 40.0789
 Wood thickness 28mm
 Wood type spruce, untreated
 Dimensions..... 320x200x260cm
 Foundation size 310x250cm
 Ridge height approx. 230cm
 Glass single glazing
 Can also be constructed in mirror image

Optional extra's

Impregnation: Green, Brown, Silver-Grey
 Impregnating Liquid in Green, Brown, Silver-Grey or Transparent (2)
 Spray-applied base coat: White, Grey, Charcoal, Transparent
 Stain (4)
 Carefree protect (4)
 Starter's set (Nails, air vent & storm anchor set)
 Foundation beams, impregnated 300cm (4)
 Foundation beams, hardwood 300cm (4)
 Foundation beams, synthetic 300cm (4)
 Construction girders, hardwood 4.0x20.0x300cm (4)
 Hardwood stakes with point 6.0x6.0x75cm (20)
 Gutter set plastic 100mm (charcoal)
 Gutter set thermally galvanised 125mm
 Roof covering kit (3)
 EPDM Adhesive
 Glazing kit white
 Wooden floor 18mm (4)
 Wooden floor 18mm impregnated (4)
 Wooden floor 26mm (5)
 Wooden floor 26mm impregnated (5)
 Additional wall layer
 Aluminium Edging Strip (6)
 Aluminium Outer Corner (4)
 Roof Duct, Round

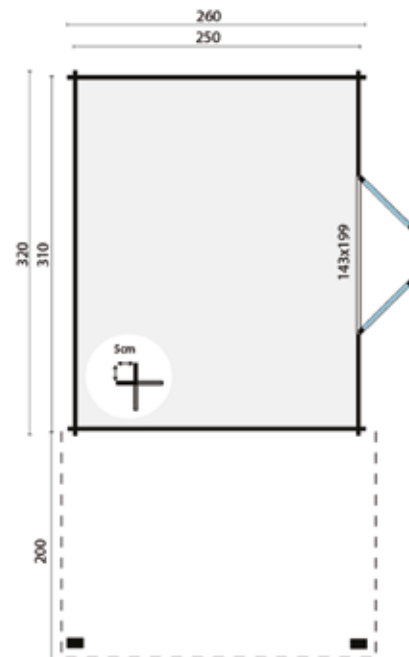

All options can be found from page 399 onwards
 Wooden floor under the Porch, see page 64 and 404



BRENDA - LOG CABIN



Optional roofing felt (20m²)
 Optional EASY-roofing (25m²)
 Optional EPDM (20m²)

Specifications:

Article no..... 40.0747
 Wood thickness 28mm
 Wood type spruce, untreated
 Dimensions..... 275+250x275cm
 Foundation size 515x255cm
 Ridge height approx. 234cm
 Windows 1 (can be opened)
 Glass single glazing

Can also be constructed in mirror image
 Side window can be placed to the left or to the right

Optional extra's

- Impregnation: Green, Brown, Silver-Grey
- Impregnating Liquid in Green, Brown, Silver-Grey or Transparent (3)
- Spray-applied base coat: White, Grey, Charcoal, Transparent
- Stain (6)
- Carefree protect (6)
- Starter's set (Nails, air vent & storm anchor set)
- Foundation beams, impregnated 300cm (5)
- Foundation beams, hardwood 300cm (5)
- Foundation beams, synthetic 300cm (5)
- Construction girders, hardwood 4.0x20.0x300cm (5)
- Hardwood stakes with point 6.0x6.0x75cm (25)
- Gutter set plastic 100mm (charcoal)
- Gutter set thermally galvanised 125mm
- Roof covering kit (3)
- EPDM Adhesive
- Glazing kit white
- Wooden floor 18mm (4)
- Wooden floor 18mm impregnated (4)
- Wooden floor 26mm (5)
- Wooden floor 26mm impregnated (5)
- Additional wall layer
- Aluminium Edging Strip (6)
- Aluminium Outer Corner (4)
- Roof Duct, Round

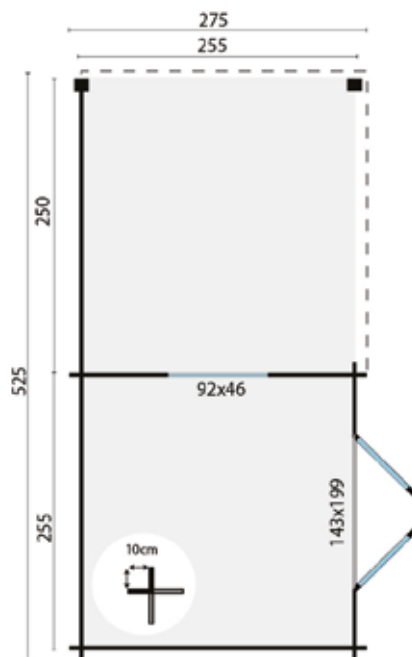

All options can be found from page 399 onwards
 Wooden floor under the Porch, see page 64 and 404

6.5m ²	15.5m ²	14.8m ³	28mm	4mm
6.4m ²				

ERICKSON - LOG CABIN



Optional roofing felt (26.5m²)
 Optional EASY-roofing (25m²)
 Optional EPDM (24m²)

Specifications:

Article no..... 40.0749
 Wood thickness 28mm
 Wood type spruce, untreated
 Dimensions..... 225+300x325cm
 Foundation size 515x305cm
 Ridge height approx. 234cm
 Windows 1 (can be opened)
 Glass single glazing

Can also be constructed in mirror image
 Side window can be placed to the left or to the right

Optional extra's

Impregnation: Green, Brown, Silver-Grey
 Impregnating Liquid in Green, Brown, Silver-Grey or Transparent (3)
 Spray-applied base coat: White, Grey, Charcoal, Transparent
 Stain (5)
 Carefree protect (5)
 Starter's set (Nails, air vent & storm anchor set)
 Foundation beams, impregnated 300cm (5)
 Foundation beams, hardwood 300cm (5)
 Foundation beams, synthetic 300cm (5)
 Construction girders, hardwood 4.0x20.0x300cm (5)
 Hardwood stakes with point 6.0x6.0x75cm (25)
 Gutter set plastic 100mm (charcoal)
 Gutter set thermally galvanised 125mm
 Roof covering kit (3)
 EPDM Adhesive
 Glazing kit white
 Wooden floor 18mm (5)
 Wooden floor 18mm impregnated (5)
 Wooden floor 26mm (6)
 Wooden floor 26mm impregnated (6)
 Additional wall layer
 Aluminium Edging Strip (6)
 Aluminium Outer Corner (4)
 Roof Duct, Round

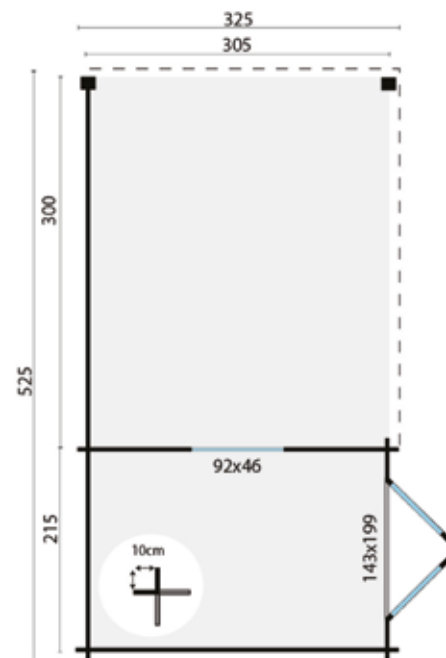

All options can be found from page 399 onwards
 Wooden floor under the Porch, see page 64 and 404



MEGAMODERN - LOG CABIN

Optional roofing felt (26m²)
 Optional EASY-roofing (25m²)
 Optional EPDM (22m²)

Specifications:

Article no..... 40.0757
 Wood thickness 28mm
 Wood type spruce, untreated
 Dimensions..... 200+375x300cm
 Foundation size 565x290cm
 Ridge height approx. 230cm
 Glass single glazing
 Can also be constructed in mirror image

Optional extra's

Impregnation: Green, Brown, Silver-Grey
 Impregnating Liquid in Green, Brown, Silver-Grey or Transparent (3)
 Spray-applied base coat: White, Grey, Charcoal, Transparent
 Stain (5)
 Carefree protect (5)
 Starter's set (Nails, air vent & storm anchor set)
 Foundation beams, impregnated 300cm (6)
 Foundation beams, hardwood 300cm (6)
 Foundation beams, synthetic 300cm (6)
 Construction girders, hardwood 4.0x20.0x300cm (6)
 Hardwood stakes with point 6.0x6.0x75cm (30)
 Gutter set plastic 100mm (charcoal)
 Gutter set thermally galvanised 125mm
 Roof covering kit (3)
 EPDM Adhesive
 Glazing kit white
 Wooden floor 18mm (3)
 Wooden floor 18mm impregnated (3)
 Wooden floor 26mm (4)
 Wooden floor 26mm impregnated (4)
 Additional wall layer
 Aluminium Edging Strip (6)
 Aluminium Outer Corner (4)
 Roof Duct, Round

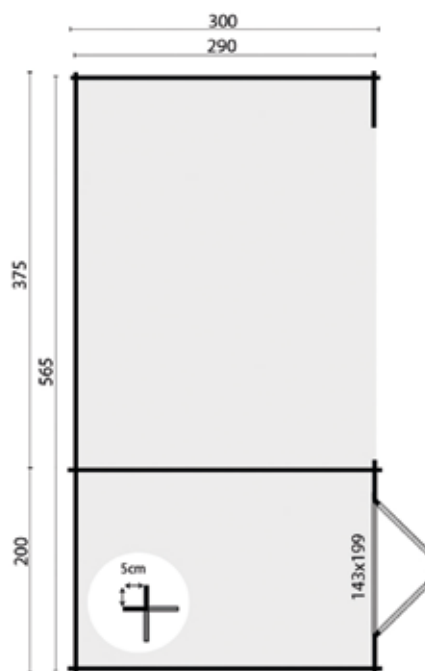

All options can be found from page 399 onwards
 Wooden floor under the Porch, see page 64 and 404



MAJA - LOG CABIN



Optional roofing felt (40m²)
 Optional EASY-roofing (30m²)
 Optional EPDM (24m²)

Specifications:

Article no..... 40.0410
 Wood thickness 28mm
 Wood type spruce, untreated
 Dimensions..... 320x320x240cm
 Foundation size 630x220cm
 Ridge height approx. 228cm
 Glass single glazing
 Balustrade included
 Can also be constructed in mirror image

Optional extra's

Impregnation: Green, Brown, Silver-Grey
 Impregnating Liquid in Green, Brown, Silver-Grey or Transparent (3)
 Spray-applied base coat: White, Grey, Charcoal, Transparent
 Stain (5)
 Carefree protect (5)
 Starter's set (Nails, air vent & storm anchor set)
 Foundation beams, impregnated 300cm (6)
 Foundation beams, hardwood 300cm (6)
 Foundation beams, synthetic 300cm (6)
 Construction girders, hardwood 4.0x20.0x300cm (6)
 Hardwood stakes with point 6.0x6.0x75cm (30)
 Gutter set plastic 100mm (charcoal)
 Gutter set thermally galvanised 125mm
 Roof covering kit (4)
 EPDM Adhesive
 Glazing kit white
 Wooden floor 18mm (4)
 Wooden floor 18mm impregnated (4)
 Wooden floor 26mm (6)
 Wooden floor 26mm impregnated (6)
 Additional wall layer
 Aluminium Edging Strip (7)
 Aluminium Outer Corner (4)
 Roof Duct, Round

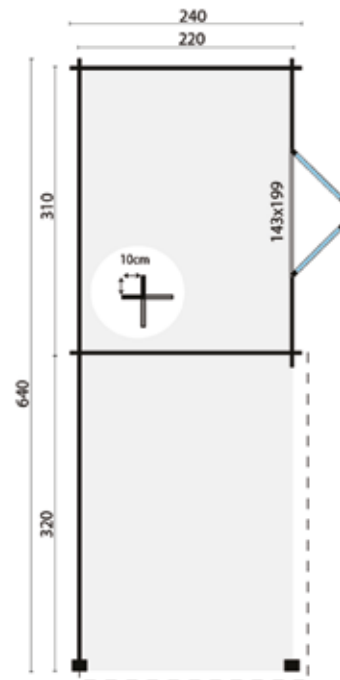

All options can be found from page 399 onwards
 Wooden floor under the Porch, see page 64 and 404

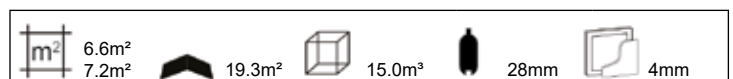

DIEDERICK - LOG CABIN



Optional roofing felt (30m²)
 Optional EASY-roofing (35m²)
 Optional EPDM (30m²)

Specifications:

Article no..... 40.0748
 Wood thickness 28mm
 Wood type spruce, untreated
 Dimensions..... 275+350x375cm
 Foundation size 615x355cm
 Ridge height approx. 234cm
 Windows 1 (can be opened)
 Glass single glazing

Can also be constructed in mirror image
 Side window can be placed to the left or to the right

Optional extra's

- Impregnation: Green, Brown, Silver-Grey
- Impregnating Liquid in Green, Brown, Silver-Grey or Transparent (3)
- Spray-applied base coat: White, Grey, Charcoal, Transparent
- Stain (6)
- Carefree protect (6)
- Starter's set (Nails, air vent & storm anchor set)
- Foundation beams, impregnated 300cm (6)
- Foundation beams, hardwood 300cm (6)
- Foundation beams, synthetic 300cm (6)
- Construction girders, hardwood 4.0x20.0x300cm (6)
- Hardwood stakes with point 6.0x6.0x75cm (30)
- Gutter set plastic 100mm (charcoal)
- Gutter set thermally galvanised 125mm
- Roof covering kit (4)
- EPDM Adhesive
- Glazing kit white
- Wooden floor 18mm (5)
- Wooden floor 18mm impregnated (5)
- Wooden floor 26mm (7)
- Wooden floor 26mm impregnated (7)
- Additional wall layer
- Aluminium Edging Strip (7)
- Aluminium Outer Corner (4)
- Roof Duct, Round

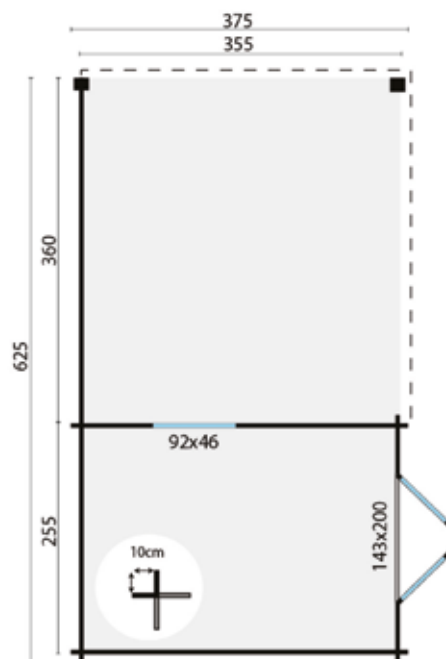

All options can be found from page 399 onwards
 Wooden floor under the Porch, see page 64 and 404

9.0m ²	24.8m ²	21.0m ³	28mm	4mm
-------------------	--------------------	--------------------	------	-----

GUNNAR - LOG CABIN

Optional EASY-roofing (40m²)
Optional EPDM (38m²)

Specifications:

Article no..... 40.0751
Wood thickness 44mm
Wood type spruce, untreated
Dimensions..... 300+425x400cm
Foundation size 715x380cm
Ridge height approx. 236cm
Windows 1 (can be opened)
Glass single glazing

Can also be constructed in mirror image
Side window can be placed to the left or to the right

Optional extra's

Impregnation: Green, Brown, Silver-Grey
Impregnating Liquid in Green, Brown, Silver-Grey or Transparent (3)
Spray-applied base coat: White, Grey, Charcoal, Transparent
Stain (5)
Carefree protect (5)
Starter's set (Nails, air vent & storm anchor set)
Foundation beams, impregnated 300cm (6)
Foundation beams, hardwood 300cm (6)
Foundation beams, synthetic 300cm (6)
Construction girders, hardwood 4.0x20.0x300cm (6)
Hardwood stakes with point 6.0x6.0x75cm (30)
Gutter set plastic 100mm (charcoal)
Gutter set thermally galvanised 125mm
EPDM Adhesive
Glazing kit white
Wooden floor 18mm (6)
Wooden floor 18mm impregnated (6)
Wooden floor 26mm (8)
Wooden floor 26mm impregnated (8)
Additional wall layer
Aluminium Edging Strip (8)
Aluminium Outer Corner (4)
Roof Duct, Round

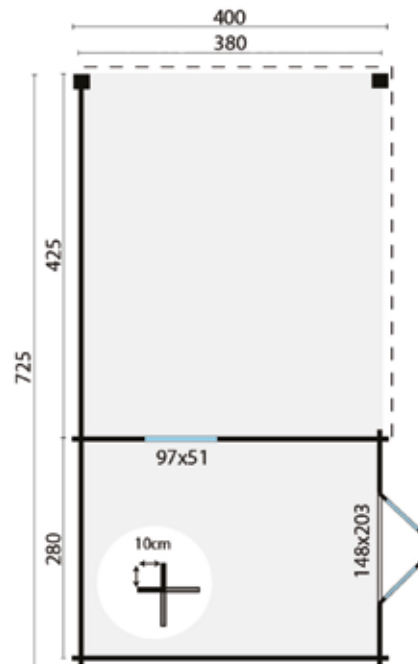

All options can be found from page 399 onwards
Wooden floor under the Porch, see page 64 and 404

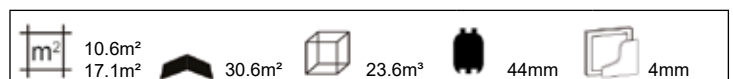

LILOU - LOG CABIN

Optional EASY-roofing (55m²)
Optional EPDM (52m²)

Specifications:

Article no..... 40.0888
Wood thickness 40mm
Wood type spruce, untreated
Dimensions..... 398+422x275+215cm
Foundation size 800x480cm
Ridge height approx. 228cm
Windows 1 (can be opened)
Glass double glazing
Supplied with separate bars for windows and doors
Can also be constructed in mirror image
Doors and windows can be placed to the left or to the right.

Optional extra's

Impregnation: Green, Brown, Silver-Grey
Impregnating Liquid in Green, Brown, Silver-Grey or Transparent (4)
Spray-applied base coat: White, Grey, Charcoal, Transparent
Stain (7)
Carefree protect (7)
Starter's set (Nails, air vent & storm anchor set) (2)
Foundation beams, impregnated 300cm (10)
Foundation beams, hardwood 300cm (10)
Foundation beams, synthetic 300cm (10)
Construction girders, hardwood 4.0x20.0x300cm (10)
Hardwood stakes with point 6.0x6.0x75cm (50)
Gutter set plastic 100mm (charcoal)
Gutter set thermally galvanised 125mm
EPDM Adhesive
Glazing kit white
Wooden floor 18mm (5)
Wooden floor 18mm impregnated (5)
Wooden floor 26mm (7)
Wooden floor 26mm impregnated (7)
Additional wall layer
Aluminium Edging Strip (10)
Aluminium Outer Corner (4)
Roof Duct, Round included (included)

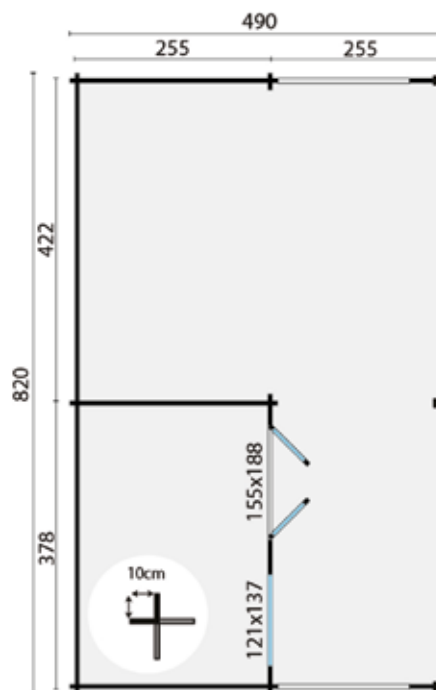

All options can be found from page 399 onwards
Wooden floor under the Porch, see page 64 and 404

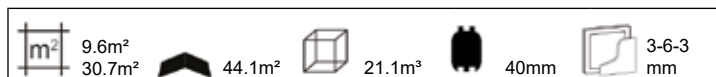

JOS - LOG CABIN



Optional roofing felt (20m²)
 Optional roof shingles, straight (15m²)
 Optional roof shingles, beaver tail (15m²)

Optional roof shingles, hexagonal (15m²)

Specifications:

Article no..... 40.0731
 Wood thickness 28mm
 Wood type spruce, untreated
 Dimensions..... 250x250cm
 Foundation size 230x230cm
 Ridge height approx. 247cm
 Windows 2 (can be opened)
 Glass single glazing
 Supplied with separate bars for windows and doors

Optional extra's

Impregnation: Green, Brown, Silver-Grey
 Impregnating Liquid in Green, Brown, Silver-Grey or Transparent (2)
 Spray-applied base coat: White, Grey, Charcoal, Transparent
 Stain (3)
 Carefree protect (3)
 Starter's set (Nails, air vent & storm anchor set)
 Foundation beams, impregnated 300cm (4)
 Foundation beams, hardwood 300cm (4)
 Foundation beams, synthetic 300cm (4)
 Construction girders, hardwood 4.0x20.0x300cm (4)
 Hardwood stakes with point 6.0x6.0x75cm (20)
 Gutter set plastic 65mm (charcoal)
 Gutter set plastic 100mm (charcoal)
 Gutter set thermally galvanised 125mm
 Gutter plank (impr. Spruce, necessary for fitting a gutter) (4)
 Glazing kit white
 Wooden floor 18mm (3)
 Wooden floor 18mm impregnated (3)
 Wooden floor 26mm (3)
 Wooden floor 26mm impregnated (3)
 Additional wall layer
 Finial with ball

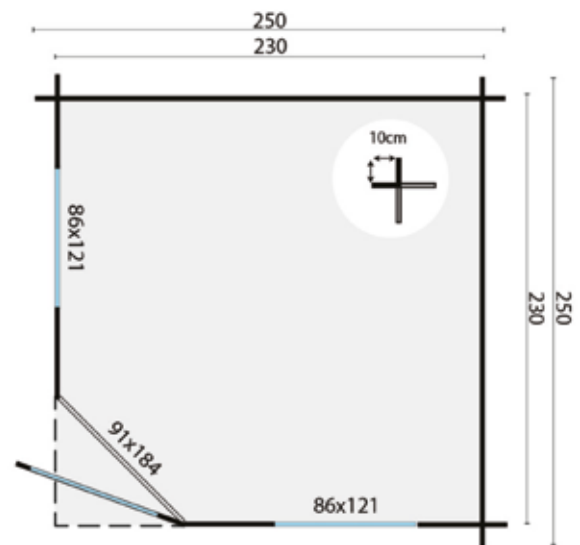

All options can be found from page 399 onwards

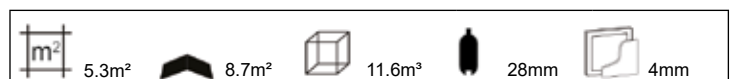

DANIËL - LOG CABIN

Optional roof shingles, straight (15m²)
 Optional roof shingles, beavertail (15m²)
 Optional roof shingles, hexagonal (15m²)

Specifications:

Article no..... 40.0764
 Wood thickness 28mm
 Wood type spruce, untreated
 Dimensions.....260x260cm
 Foundation size240x240cm
 Ridge height approx. 298cm
 Windows 2 (can be opened)
 Glass single glazing
 Supplied with fixed bars windows and doors

Optional extra's

Impregnation: Green
 Impregnation: Brown, Silver-Grey
 Impregnating Liquid in Green, Brown, Silver-Grey or Transparent (2)
 Spray-applied base coat: White, Grey, Charcoal, Transparent
 Stain (4)
 Carefree protect (4)
 Starter's set (Nails, air vent & storm anchor set)
 Foundation beams, impregnated 300cm (4)
 Foundation beams, hardwood 300cm (4)
 Foundation beams, synthetic 300cm (4)
 Construction girders, hardwood 4.0x20.0x300cm (4)
 Hardwood stakes with point 6.0x6.0x75cm (20)
 Gutter set plastic 65mm (charcoal)
 Gutter set plastic 100mm (charcoal)
 Gutter set thermally galvanised 125mm
 Gutter plank (impr. Spruce, necessary for fitting a gutter) (4)
 Roof covering kit (3)
 Glazing kit white
 Wooden floor 18mm (3)
 Wooden floor 18mm impregnated (3)
 Wooden floor 26mm (4)
 Wooden floor 26mm impregnated (4)
 Additional wall layer
 Finial with ball

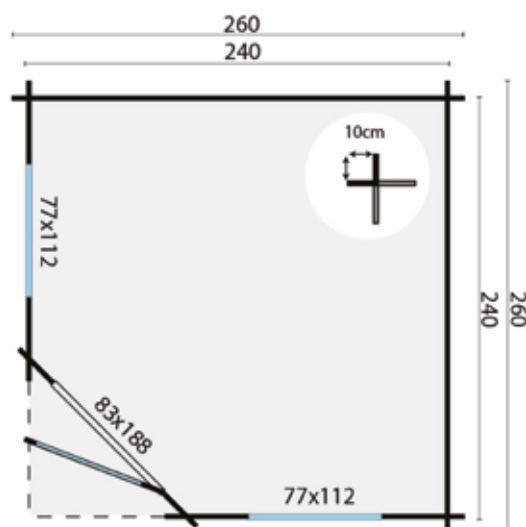

All options can be found from page 399 onwards

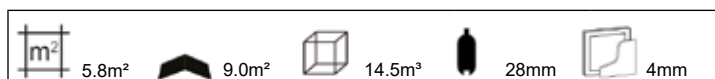

ASMUND - LOG CABIN

Optional roofing felt (30m²)
 Optional roof shingles, straight (18m²)
 Optional roof shingles, beavertail (18m²)

Optional roof shingles, hexagonal (18m²)

Specifications:

Article no..... 40.0723
 Wood thickness 28mm
 Wood type spruce, untreated
 Dimensions..... 300x300cm
 Foundation size 280x280cm
 Ridge height approx. 250cm
 Windows 2 (can be opened)
 Glass single glazing
 Supplied with separate bars for windows and doors

Optional extra's

Impregnation: Green, Brown, Silver-Grey
 Impregnating Liquid in Green, Brown, Silver-Grey or Transparent (3)
 Spray-applied base coat: White, Grey, Charcoal, Transparent
 Stain (5)
 Carefree protect (5)
 Starter's set (Nails, air vent & storm anchor set)
 Foundation beams, impregnated 300cm (4)
 Foundation beams, hardwood 300cm (4)
 Foundation beams, synthetic 300cm (4)
 Construction girders, hardwood 4.0x20.0x300cm (4)
 Hardwood stakes with point 6.0x6.0x75cm (20)
 Gutter set plastic 65mm (charcoal)
 Gutter set plastic 100mm (charcoal)
 Gutter set thermally galvanised 125mm
 Gutter plank (impr. Spruce, necessary for fitting a gutter) (4)
 Roof covering kit (3)
 Glazing kit white
 Wooden floor 18mm (4)
 Wooden floor 18mm impregnated (4)
 Wooden floor 26mm (6)
 Wooden floor 26mm impregnated (6)
 Additional wall layer
 Finial with ball



All options can be found from page 399 onwards

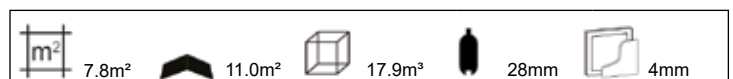

INGRID - LOG CABIN



Optional roof shingles, straight (18m²)
 Optional roof shingles, beavertail (18m²)
 Optional roof shingles, hexagonal (18m²)

Specifications:

Article no..... 40.0770
 Wood thickness 28mm
 Wood type spruce, untreated
 Dimensions..... 300x300cm
 Foundation size 280x280cm
 Ridge height approx. 298cm
 Windows 2 (can be opened)
 Glass single glazing
 Supplied with fixed bars for windows and doors

Optional extra's

- Impregnation: Green, Brown, Silver-Grey
- Impregnating Liquid in Green, Brown, Silver-Grey or Transparent (3)
- Spray-applied base coat: White, Grey, Charcoal, Transparent
- Stain (5)
- Carefree protect (5)
- Starter's set (Nails, air vent & storm anchor set)
- Foundation beams, impregnated 300cm (4)
- Foundation beams, hardwood 300cm (4)
- Foundation beams, synthetic 300cm (4)
- Construction girders, hardwood 4.0x20.0x300cm (4)
- Hardwood stakes with point 6.0x6.0x75cm (20)
- Gutter set plastic 65mm (charcoal)
- Gutter set plastic 100mm (charcoal)
- Gutter set thermally galvanised 125mm
- Gutter plank (impr. Spruce, necessary for fitting a gutter) (4)
- Roof covering kit (3)
- Glazing kit white
- Wooden floor 18mm (4)
- Wooden floor 18mm impregnated (4)
- Wooden floor 26mm (6)
- Wooden floor 26mm impregnated (6)
- Additional wall layer
- Finial with ball

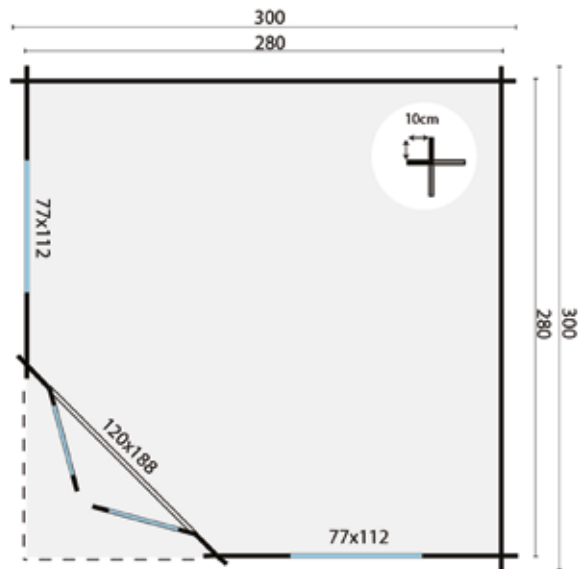

All options can be found from page 399 onwards

m² 7.8m²
 11.5m²
 19.5m³
 28mm
 4mm

EMMA - LOG CABIN

- Optional roof shingles, straight (18m²)
- Optional roof shingles, beavertail (18m²)
- Optional roof shingles, hexagonal (18m²)

Specifications:

Article no.....	40.7214
Wood thickness	40mm
Wood type	spruce, untreated
Dimensions.....	302x302cm
Foundation size	282x282cm
Ridge height	approx. 250cm
Windows	2 (can be opened)
Glass	double glazing
Supplied with separate bars for windows and doors	

Optional extra's

- Impregnation: Green, Brown, Silver-Grey
- Impregnating Liquid in Green, Brown, Silver-Grey or Transparent (3)
- Spray-applied base coat: White, Grey, Charcoal, Transparent Stain (5)
- Starter's set (Nails, air vent & storm anchor set)
- Carefree protect (5)
- Foundation beams, impregnated 300cm (4)
- Foundation beams, hardwood 300cm (4)
- Foundation beams, synthetic 300cm (4)
- Construction girders, hardwood 4.0x20.0x300cm (4)
- Hardwood stakes with point 6.0x6.0x75cm (20)
- Gutter set plastic 65mm (charcoal)
- Gutter set plastic 100mm (charcoal)
- Gutter set thermally galvanised 125mm
- Gutter plank (impr. Spruce, necessary for fitting a gutter) (4)
- Roof covering kit (3)
- Glazing kit white
- Wooden floor 18mm (4)
- Wooden floor 18mm impregnated (4)
- Wooden floor 26mm (6)
- Wooden floor 26mm impregnated (6)
- Additional wall layer
- Finial with ball

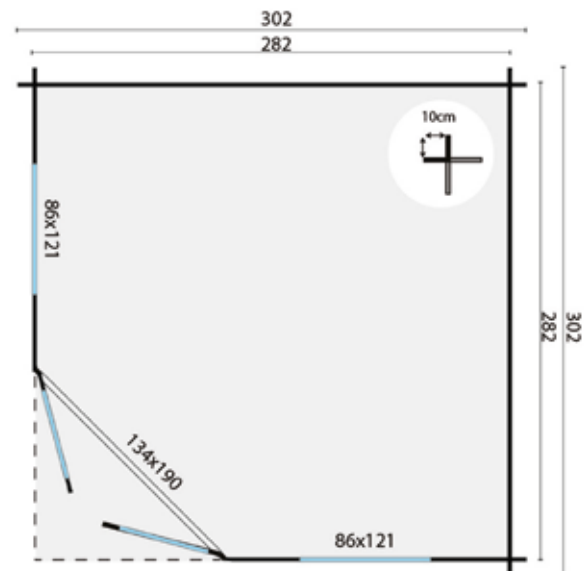

All options can be found from page 399 onwards

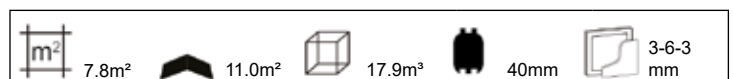

DAGMAR - LOG CABIN



Optional roof shingles, straight (24m²)
 Optional roof shingles, beavertail (24m²)
 Optional roof shingles, hexagonal (24m²)

Specifications:

Article no..... 40.0801
 Wood thickness 28mm
 Wood type spruce, untreated
 Dimensions..... 350x350cm
 Foundation size 330x330cm
 Ridge height approx. 298cm
 Windows 2 (can be opened)
 Glass single glazing
 Supplied with fixed bars windows and doors

Optional extra's

- Impregnation: Green, Brown, Silver-Grey
- Impregnating Liquid in Green, Brown, Silver-Grey or Transparent (3)
- Spray-applied base coat: White, Grey, Charcoal, Transparent
- Stain (5)
- Carefree protect (5)
- Starter's set (Nails, air vent & storm anchor set)
- Foundation beams, impregnated 300cm (5)
- Foundation beams, hardwood 300cm (5)
- Foundation beams, synthetic 300cm (5)
- Construction girders, hardwood 4.0x20.0x300cm (5)
- Hardwood stakes with point 6.0x6.0x75cm (25)
- Gutter set plastic 65mm (charcoal)
- Gutter set plastic 100mm (charcoal)
- Gutter set thermally galvanised 125mm
- Gutter plank (impr. Spruce, necessary for fitting a gutter) (4)
- Roof covering kit (3)
- Glazing kit white
- Wooden floor 18mm (5)
- Wooden floor 18mm impregnated (5)
- Wooden floor 26mm (7)
- Wooden floor 26mm impregnated (7)
- Additional wall layer
- Finial with ball

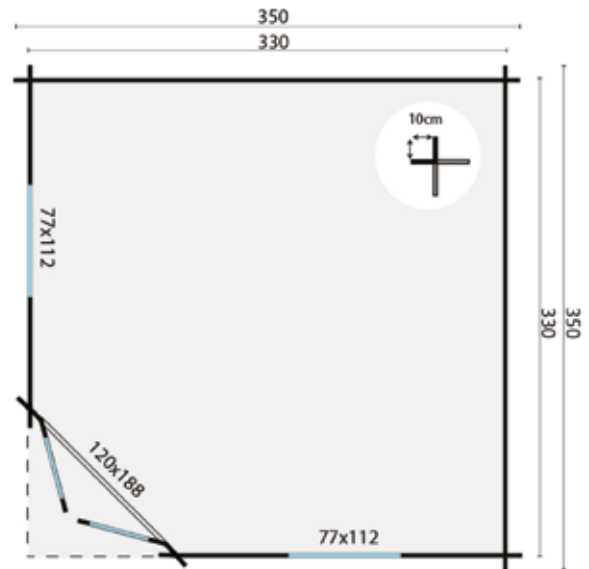

All options can be found from page 399 onwards

10.8m²
15.6m²
27.0m³
28mm
4mm

NILSSON - LOG CABIN

- Optional roof shingles, straight (27m²)
- Optional roof shingles, beavertail (27m²)
- Optional roof shingles, hexagonal (27m²)

Specifications:

Article no.....	40.0773
Wood thickness	44mm
Wood type	spruce, untreated
Dimensions.....	350x350cm
Foundation size	330x330cm
Ridge height	approx. 290cm
Windows	2 (can be opened)
Glass	single glazing
Supplied with separate bars for windows and doors	

Optional extra's

- Impregnation: Green, Brown, Silver-Grey
- Impregnating Liquid in Green, Brown, Silver-Grey or Transparent (3)
- Spray-applied base coat: White, Grey, Charcoal, Transparent
- Stain (5)
- Carefree protect (5)
- Starter's set (Nails, air vent & storm anchor set)
- Foundation beams, impregnated 300cm (5)
- Foundation beams, hardwood 300cm (5)
- Foundation beams, synthetic 300cm (5)
- Construction girders, hardwood 4.0x20.0x300cm (5)
- Hardwood stakes with point 6.0x6.0x75cm (25)
- Gutter set plastic 65mm (charcoal)
- Gutter set plastic 100mm (charcoal)
- Gutter set thermally galvanised 125mm
- Gutter plank (impr. Spruce, necessary for fitting a gutter) (4)
- Roof covering kit (3)
- Glazing kit white
- Wooden floor 18mm (5)
- Wooden floor 18mm impregnated (5)
- Wooden floor 26mm (7)
- Wooden floor 26mm impregnated (7)
- Additional wall layer
- Finial with ball

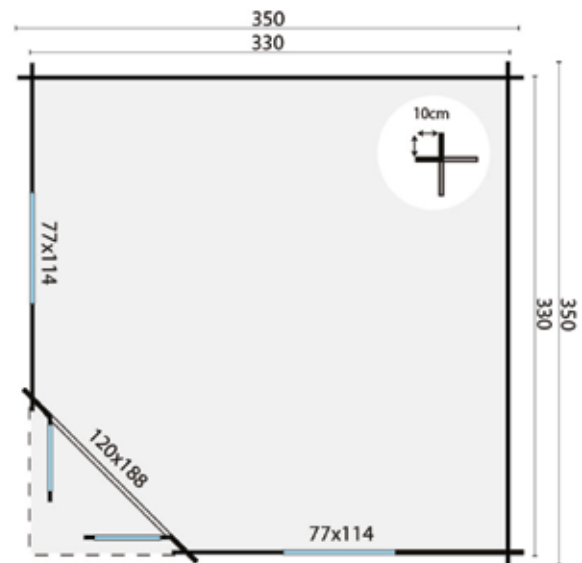

All options can be found from page 399 onwards



LOTTE - LOG CABIN



- Optional roof shingles, straight (27m²)
- Optional roof shingles, beavertail (27m²)
- Optional roof shingles, hexagonal (27m²)

Specifications:

Article no..... 40.0780
 Wood thickness 44mm
 Wood type spruce, untreated
 Dimensions.....400x400cm
 Foundation size380x380cm
 Ridge height approx. 302cm
 Windows 2 (can be opened)
 Glass single glazing
 Supplied with separate bars for windows and doors

Optional extra's

- Impregnation: Green, Brown, Silver-Grey
- Impregnating Liquid in Green, Brown, Silver-Grey or Transparent (3)
- Spray-applied base coat: White, Grey, Charcoal, Transparent
- Stain (5)
- Carefree protect (5)
- Starter's set (Nails, air vent & storm anchor set)
- Foundation beams, impregnated 300cm (6)
- Foundation beams, hardwood 300cm (6)
- Foundation beams, synthetic 300cm (6)
- Construction girders, hardwood 4.0x20.0x300cm (6)
- Hardwood stakes with point 6.0x6.0x75cm (30)
- Gutter set plastic 65mm (charcoal)
- Gutter set plastic 100mm (charcoal)
- Gutter set thermally galvanised 125mm
- Gutter plank (impr. Spruce, necessary for fitting a gutter) (5)
- Roof covering kit (4)
- Glazing kit white
- Wooden floor 18mm (7)
- Wooden floor 18mm impregnated (7)
- Wooden floor 26mm (9)
- Wooden floor 26mm impregnated (9)
- Additional wall layer
- Finial with ball

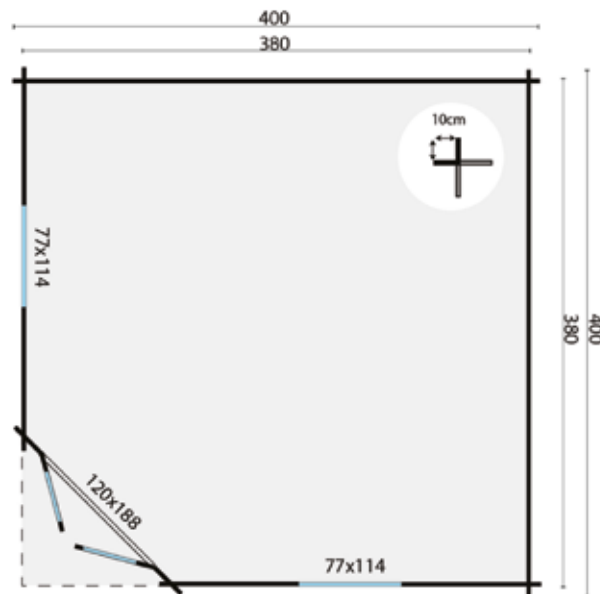

All options can be found from page 399 onwards

	13.2m ²		21.0m ²		33.0m ³		44mm		4mm
--	--------------------	--	--------------------	--	--------------------	--	------	--	-----

NORA - LOG CABIN



Optional roof shingles, straight (21m²)
 Optional roof shingles, beavertail (21m²)
 Optional roof shingles, hexagonal (21m²)

Specifications:

Article no..... 40.0736
 Wood thickness 34mm
 Wood type spruce, untreated
 Dimensions..... 354x316cm
 Ridge height approx. 298cm
 Windows 2 (can be opened)
 Glass single glazing
 Supplied with separate bars for windows and doors
 Windows to be fitted in every wall

Optional extra's

Impregnation: Green, Brown, Silver-Grey
 Impregnating Liquid in Green, Brown, Silver-Grey or Transparent (2)
 Spray-applied base coat: White, Grey, Charcoal, Transparent
 Stain (4)
 Carefree protect (4)
 Starter's set (Nails, air vent & storm anchor set)
 Foundation beams, impregnated 300cm (5)
 Foundation beams, hardwood 300cm (5)
 Foundation beams, synthetic 300cm (5)
 Construction girders, hardwood 4.0x20.0x300cm (5)
 Hardwood stakes with point 6.0x6.0x75cm (25)
 Roof covering kit (4)
 Glazing kit white
 Wooden floor 18mm (5)
 Wooden floor 18mm impregnated (5)
 Wooden floor 26mm (6)
 Wooden floor 26mm impregnated (6)
 Additional wall layer
 Finial with ball

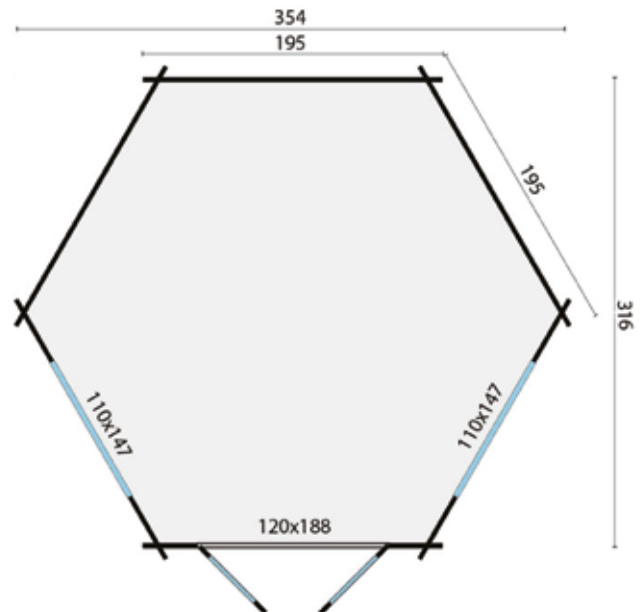

All options can be found from page 399 onwards

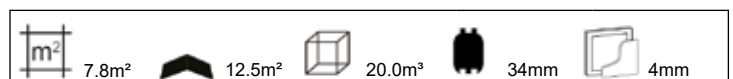

LYNN - LOG CABIN

Optional roof shingles, straight (30m²)
 Optional roof shingles, beavertail (30m²)
 Optional roof shingles, hexagonal (30m²)

Specifications:

Article no..... 40.0761
 Wood thickness 44mm
 Wood type spruce, untreated
 Dimensions..... Ø 418cm
 Ridge height approx. 306cm
 Windows 4 (can be opened)
 Glass single glazing
 Supplied with separate bars for windows and doors
 Windows to be fitted in every wall

Optional extra's

Impregnation: Green, Brown, Silver-Grey
 Impregnating Liquid in Green, Brown, Silver-Grey or Transparent (3)
 Spray-applied base coat: White, Grey, Charcoal, Transparent
 Stain (5)
 Carefree protect (5)
 Starter's set (Nails, air vent & storm anchor set)
 Foundation beams, impregnated 300cm (6)
 Foundation beams, hardwood 300cm (6)
 Foundation beams, synthetic 300cm (6)
 Construction girders, hardwood 4.0x20.0x300cm (6)
 Hardwood stakes with point 6.0x6.0x75cm (30)
 Roof covering kit (4)
 Glazing kit white
 Wooden floor 18mm (7)
 Wooden floor 18mm impregnated (7)
 Wooden floor 26mm (10)
 Wooden floor 26mm impregnated (10)
 Finial with ball

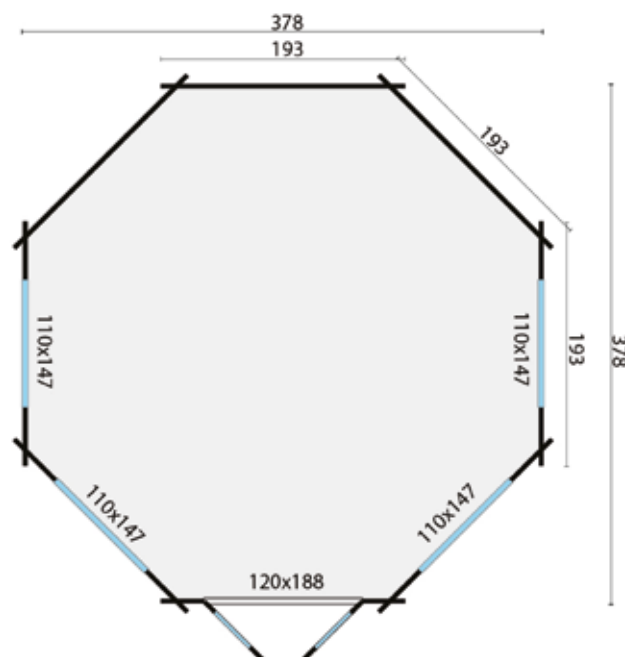

All options can be found from page 399 onwards

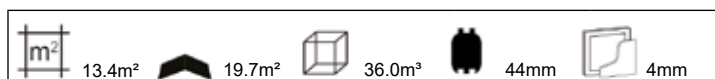

SIGRID - LOG CABIN

- Optional roof shingles, straight (27m²)
- Optional roof shingles, beavertail (27m²)
- Optional roof shingles, hexagonal (27m²)

Specifications:

Article no.....	40.0772
Wood thickness	28mm
Wood type	spruce, untreated
Dimensions.....	300+140x300cm
Foundation size	420x280cm
Ridge height	approx. 298cm
Windows	2 (can be opened)
Glass	single glazing
Supplied with fixed bars for windows and doors	
Can also be constructed in mirror image	

Optional extra's

- Impregnation: Green, Brown, Silver-Grey
- Impregnating Liquid in Green, Brown, Silver-Grey or Transparent (3)
- Spray-applied base coat: White, Grey, Charcoal, Transparent
- Stain (5)
- Carefree protect (5)
- Starter's set (Nails, air vent & storm anchor set)
- Foundation beams, impregnated 300cm (6)
- Foundation beams, hardwood 300cm (6)
- Foundation beams, synthetic 300cm (6)
- Construction girders, hardwood 4.0x20.0x300cm (6)
- Hardwood stakes with point 6.0x6.0x75cm (30)
- Gutter set plastic 65mm (charcoal)
- Gutter set plastic 100mm (charcoal)
- Gutter set thermally galvanised 125mm
- Gutter plank (impr. Spruce, necessary for fitting a gutter) (4)
- Roof covering kit (4)
- Glazing kit white
- Wooden floor 18mm (6)
- Wooden floor 18mm impregnated (6)
- Wooden floor 26mm (8)
- Wooden floor 26mm impregnated (8)
- Additional wall layer
- Finial with ball (2)

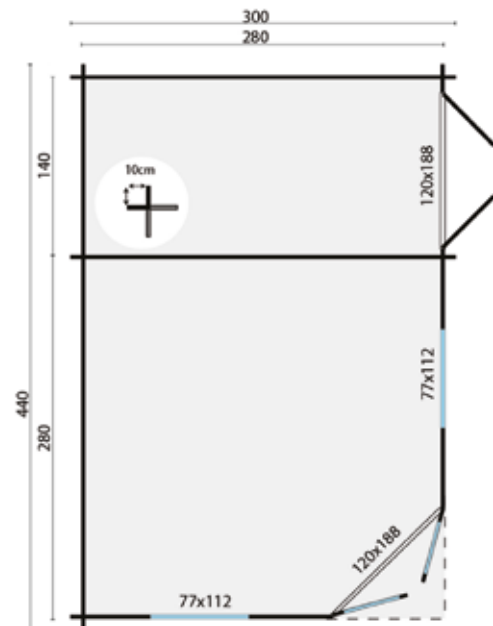

All options can be found from page 399 onwards

7.8m ² 3.6m ²	19.4m ²	28.6m ³	28mm	4mm
--	--------------------	--------------------	------	-----

AGNES - LOG CABIN

Optional roof shingles, straight (27m²)
 Optional roof shingles, beavertail (27m²)
 Optional roof shingles, hexagonal (27m²)

Specifications:

Article no..... 40.0781
 Wood thickness 44mm
 Wood type spruce, untreated
 Dimensions..... 300+140x300cm
 Foundation size 420x280cm
 Ridge height approx. 298cm
 Windows 2 (can be opened)
 Glass single glazing
 Supplied with fixed bars for windows and doors
 Can also be constructed in mirror image

Optional extra's

Impregnation: Green, Brown, Silver-Grey
 Impregnating Liquid in Green, Brown, Silver-Grey or Transparent (3)
 Spray-applied base coat: White, Grey, Charcoal, Transparent
 Stain (5)
 Carefree protect (5)
 Starter's set (Nails, air vent & storm anchor set)
 Foundation beams, impregnated 300cm (6)
 Foundation beams, hardwood 300cm (6)
 Foundation beams, synthetic 300cm (6)
 Construction girders, hardwood 4.0x20.0x300cm (6)
 Hardwood stakes with point 6.0x6.0x75cm (30)
 Gutter set plastic 65mm (charcoal)
 Gutter set plastic 100mm (charcoal)
 Gutter set thermally galvanised 125mm
 Gutter plank (impr. Spruce, necessary for fitting a gutter) (4)
 Glazing kit white
 Wooden floor 18mm (6)
 Wooden floor 18mm impregnated (6)
 Wooden floor 26mm (8)
 Wooden floor 26mm impregnated (8)
 Additional wall layer
 Finial with ball (2)

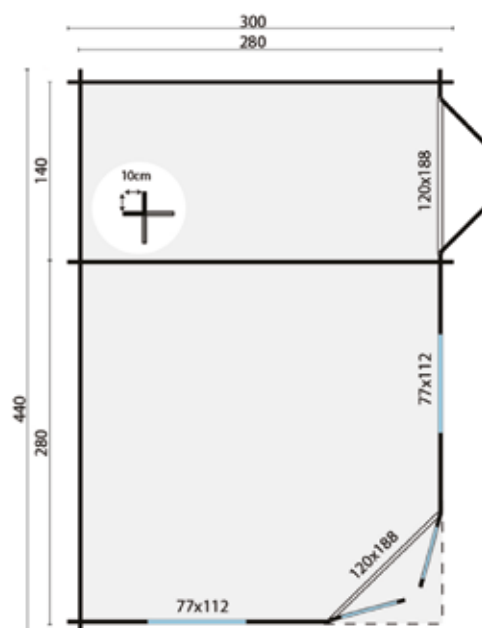

All options can be found from page 399 onwards

7.8m ² 3.6m ²	19.4m ²	28.6m ³	44mm	4mm
--	--------------------	--------------------	------	-----

HELGE - LOG CABIN

Optional roofing felt (26m²)
 Optional EASY-roofing (30m²)
 Optional EPDM (23m²)

Specifications:

Article no..... 40.0795
 Wood thickness 44mm
 Wood type spruce, untreated
 Dimensions..... 350+150x350cm
 Foundation size 480x330cm
 Ridge height approx. 226cm
 Windows 2 (can be opened)
 Glass single glazing
 Supplied with fixed bars for windows and doors
 Can also be constructed in mirror image

Optional extra's

Impregnation: Green, Brown, Silver-Grey
 Impregnating Liquid in Green, Brown, Silver-Grey or Transparent (3)
 Spray-applied base coat: White, Grey, Charcoal, Transparent
 Stain (6)
 Carefree protect (6)
 Starter's set (Nails, air vent & storm anchor set)
 Foundation beams, impregnated 300cm (7)
 Foundation beams, hardwood 300cm (7)
 Foundation beams, synthetic 300cm (7)
 Construction girders, hardwood 4.0x20.0x300cm (7)
 Hardwood stakes with point 6.0x6.0x75cm (35)
 Gutter set plastic 100mm (charcoal)
 Gutter set thermally galvanised 125mm
 Roof covering kit (4)
 EPDM Adhesive
 Glazing kit white
 Wooden floor 18mm (8)
 Wooden floor 18mm impregnated (8)
 Wooden floor 26mm (11)
 Wooden floor 26mm impregnated (11)
 Additional wall layer
 Aluminium Edging Strip (6)
 Aluminium Outer Corner (4)
 Roof Duct, Round

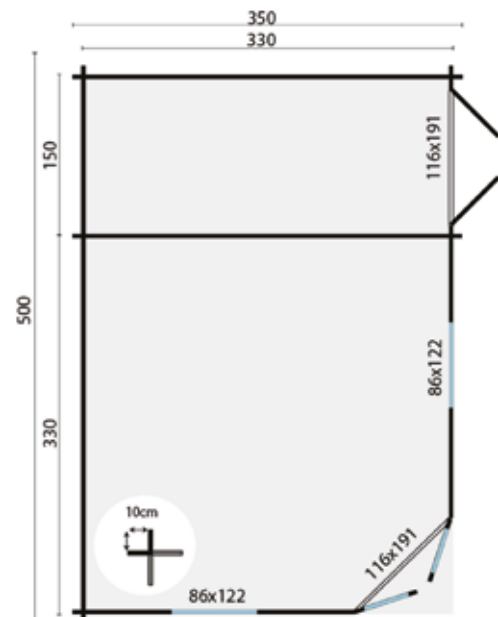

All options can be found from page 399 onwards



STIG - LOG CABIN

Optional roofing felt (26.5m²)
 Optional EASY-roofing (25m²)
 Optional EPDM (22m²)

Specifications:

Article no..... 40.0887
 Wood thickness 28mm
 Wood type spruce, untreated
 Dimensions..... 250+250x300cm
 Foundation size 480x280cm
 Ridge height approx. 224cm
 Windows 2 (can be opened)
 Glass single glazing
 Supplied with fixed bars for windows and doors
 Can also be constructed in mirror image

Optional extra's

Impregnation: Green, Brown, Silver-Grey
 Impregnating Liquid in Green, Brown, Silver-Grey or Transparent (2)
 Spray-applied base coat: White, Grey, Charcoal, Transparent
 Stain (4)
 Carefree protect (4)
 Starter's set (Nails, air vent & storm anchor set)
 Foundation beams, impregnated 300cm (5)
 Foundation beams, hardwood 300cm (5)
 Foundation beams, synthetic 300cm (5)
 Construction girders, hardwood 4.0x20.0x300cm (5)
 Hardwood stakes with point 6.0x6.0x75cm (25)
 Gutter set plastic 100mm (charcoal)
 Gutter set thermally galvanised 125mm
 Roof covering kit (4)
 EPDM Adhesive
 Glazing kit white
 Wooden floor 18mm (4)
 Wooden floor 18mm impregnated (4)
 Wooden floor 26mm (5)
 Wooden floor 26mm impregnated (5)
 Additional wall layer
 Aluminium Edging Strip (6)
 Aluminium Outer Corner (4)
 Roof Duct, Round

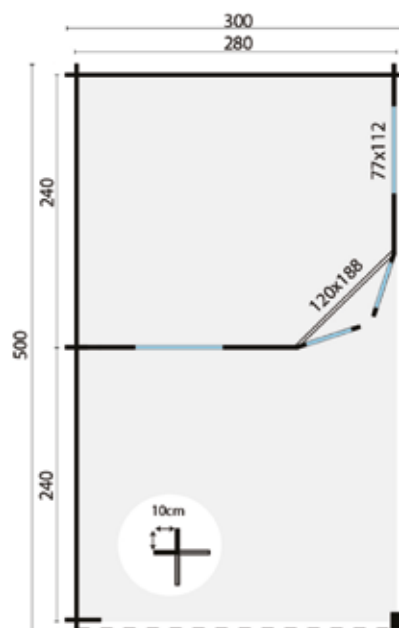

All options can be found from page 399 onwards
 Wooden floor under the Porch, see page 64 and 404

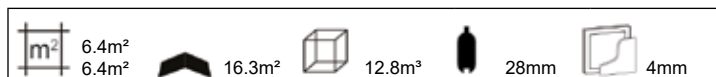

KENNET - LOG CABIN



Optional roof shingles, straight (27m²)
 Optional roof shingles, beavertail (27m²)
 Optional roof shingles, hexagonal (27m²)

Specifications:

Article no..... 40.0882
 Wood thickness 28mm
 Wood type spruce, untreated
 Dimensions..... 250+250x300cm
 Foundation size 480x280cm
 Ridge height approx. 271cm
 Windows 2 (can be opened)
 Glass single glazing
 Supplied with fixed bars for windows and doors
 Can also be constructed in mirror image

Optional extra's

Impregnation: Green, Brown, Silver-Grey
 Impregnating Liquid in Green, Brown, Silver-Grey or Transparent (3)
 Spray-applied base coat: White, Grey, Charcoal, Transparent
 Stain (5)
 Carefree protect (5)
 Starter's set (Nails, air vent & storm anchor set)
 Foundation beams, impregnated 300cm (5)
 Foundation beams, hardwood 300cm (5)
 Foundation beams, synthetic 300cm (5)
 Construction girders, hardwood 4.0x20.0x300cm (5)
 Hardwood stakes with point 6.0x6.0x75cm (25)
 Gutter set plastic 65mm (charcoal)
 Gutter set plastic 100mm (charcoal)
 Gutter set thermally galvanised 125mm
 Gutter plank (impr. Spruce, necessary for fitting a gutter) (5)
 Skylight (only with roofing felt and roof shingles)
 Roof covering kit (4)
 Glazing kit white
 Wooden floor 18mm (4)
 Wooden floor 18mm impregnated (4)
 Wooden floor 26mm (5)
 Wooden floor 26mm impregnated (5)
 Additional wall layer
 Finial with ball (2)

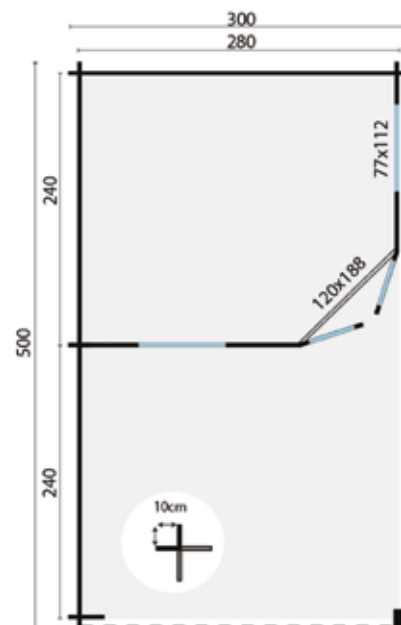

All options can be found from page 399 onwards
 Wooden floor under the Porch, see page 64 and 404

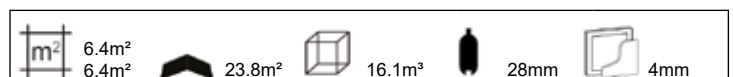

CHRISTOFFER - LOG CABIN

Optional roof shingles, straight (33m²)
 Optional roof shingles, beavertail (33m²)
 Optional roof shingles, hexagonal (33m²)

Specifications:

Article no..... 40.0883
 Wood thickness 28mm
 Wood type spruce, untreated
 Dimensions..... 300+275x350cm
 Foundation size 555x330cm
 Ridge height approx. 305cm
 Windows 2 (can be opened)
 Glass single glazing
 Supplied with fixed bars for windows and doors
 Can also be constructed in mirror image

Optional extra's

Impregnation: Green, Brown, Silver-Grey
 Impregnating Liquid in Green, Brown, Silver-Grey or Transparent (3)
 Spray-applied base coat: White, Grey, Charcoal, Transparent
 Stain (6)
 Carefree protect (6)
 Starter's set (Nails, air vent & storm anchor set)
 Foundation beams, impregnated 300cm (6)
 Foundation beams, hardwood 300cm (6)
 Foundation beams, synthetic 300cm (6)
 Construction girders, hardwood 4.0x20.0x300cm (6)
 Hardwood stakes with point 6.0x6.0x75cm (30)
 Gutter set plastic 65mm (charcoal)
 Gutter set plastic 100mm (charcoal)
 Gutter set thermally galvanised 125mm
 Gutter plank (impr. Spruce, necessary for fitting a gutter) (5)
 Skylight (only with roofing felt and roof shingles)
 Roof covering kit (4)
 Glazing kit white
 Wooden floor 18mm (5)
 Wooden floor 18mm impregnated (5)
 Wooden floor 26mm (7)
 Wooden floor 26mm impregnated (7)
 Additional wall layer
 Finial with ball (2)

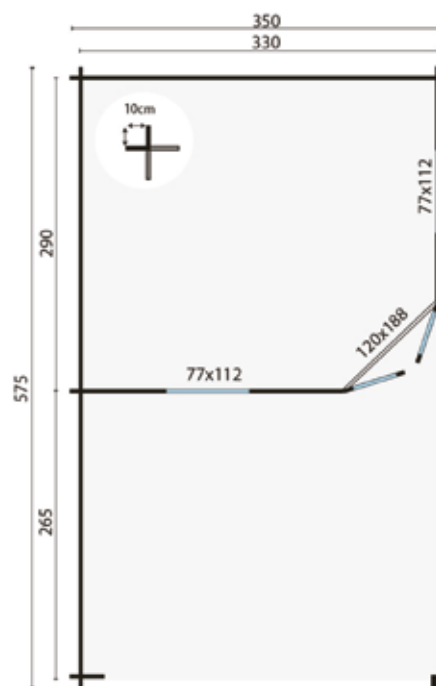

All options can be found from page 399 onwards
 Wooden floor under the Porch, see page 64 and 404

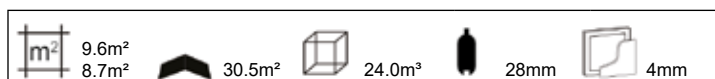

NIKLAS - LOG CABIN



- Optional roof shingles, straight (27m²)
- Optional roof shingles, beavertail (27m²)
- Optional roof shingles, hexagonal (27m²)

Specifications:

Article no.....	40.0725
Wood thickness	28mm
Wood type	spruce, untreated
Dimensions.....	250+325x250cm
Foundation size	555x230cm
Ridge height	approx. 259cm
Windows	2 (can be opened)
Glass	single glazing
Supplied with fixed bars for windows and doors	
Can also be constructed in mirror image	

Optional extra's

- Impregnation: Green, Brown, Silver-Grey
- Impregnating Liquid in Green, Brown, Silver-Grey or Transparent (3)
- Spray-applied base coat: White, Grey, Charcoal, Transparent
- Stain (5)
- Carefree protect (5)
- Starter's set (Nails, air vent & storm anchor set)
- Foundation beams, impregnated 300cm (5)
- Foundation beams, hardwood 300cm (5)
- Foundation beams, synthetic 300cm (5)
- Construction girders, hardwood 4.0x20.0x300cm (5)
- Hardwood stakes with point 6.0x6.0x75cm (25)
- Gutter set plastic 65mm (charcoal)
- Gutter set plastic 100mm (charcoal)
- Gutter set thermally galvanised 125mm
- Gutter plank (impr. Spruce, necessary for fitting a gutter) (5)
- Skylight (only with roofing felt and roof shingles)
- Roof covering kit (4)
- Glazing kit white
- Wooden floor 18mm (4)
- Wooden floor 18mm impregnated (4)
- Wooden floor 26mm (5)
- Wooden floor 26mm impregnated (5)
- Additional wall layer
- Finial with ball (2)

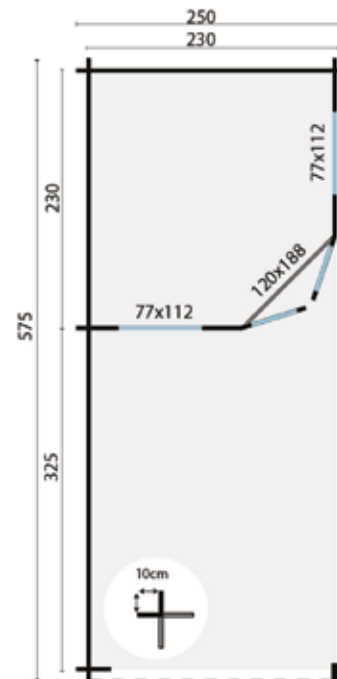

All options can be found from page 399 onwards
Wooden floor under the Porch, see page 64 and 404

5.3m ² 7.0m ²	21.8m ²	11.9m ³	28mm	4mm
--	--------------------	--------------------	------	-----

MARKKU - LOG CABIN



- Optional roof shingles, straight (30m²)
- Optional roof shingles, beavertail (30m²)
- Optional roof shingles, hexagonal (30m²)

Specifications:

- Article no..... 40.0724
- Wood thickness 28mm
- Wood type spruce, untreated
- Dimensions..... 300x275x300cm
- Foundation size 555x280cm
- Ridge height approx. 271cm
- Windows 2 (can be opened)
- Glass single glazing
- Supplied with fixed bars for windows and doors
- Can also be constructed in mirror image

Optional extra's

- Impregnation: Green, Brown, Silver-Grey
- Impregnating Liquid in Green, Brown, Silver-Grey or Transparent (3)
- Spray-applied base coat: White, Grey, Charcoal, Transparent Stain (5)
- Carefree protect (5)
- Starter's set (Nails, air vent & storm anchor set)
- Foundation beams, impregnated 300cm (5)
- Foundation beams, hardwood 300cm (5)
- Foundation beams, synthetic 300cm (5)
- Construction girders, hardwood 4.0x20.0x300cm (5)
- Hardwood stakes with point 6.0x6.0x75cm (25)
- Gutter set plastic 65mm (charcoal)
- Gutter set plastic 100mm (charcoal)
- Gutter set thermally galvanised 125mm
- Gutter plank (impr. Spruce, necessary for fitting a gutter) (5)
- Skylight (only with roofing felt and roof shingles)
- Roof covering kit (4)
- Glazing kit white
- Wooden floor 18mm (4)
- Wooden floor 18mm impregnated (4)
- Wooden floor 26mm (5)
- Wooden floor 26mm impregnated (5)
- Additional wall layer
- Finial with ball (2)

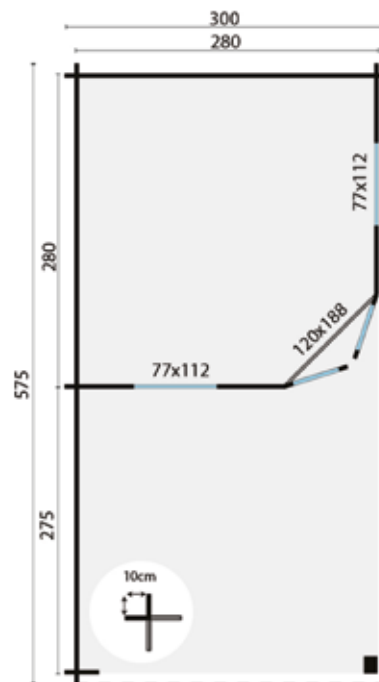

All options can be found from page 399 onwards
 Wooden floor under the Porch, see page 64 and 404

7.8m ²	25.2m ²	19.5m ³	28mm	4mm
7.1m ²				

OLSON - LOG CABIN

Optional roof shingles, straight (39m²)
 Optional roof shingles, beavertail (39m²)
 Optional roof shingles, hexagonal (39m²)

Specifications:

Article no..... 40.0726
 Wood thickness 44mm
 Wood type spruce, untreated
 Dimensions..... 300+140+265x300cm
 Foundation size 685x280cm
 Ridge height approx. 292cm
 Windows 2 (can be opened)
 Glass single glazing
 Supplied with separate bars for windows and doors
 Can also be constructed in mirror image

Optional extra's

Impregnation: Green, Brown, Silver-Grey
 Impregnating Liquid in Green, Brown, Silver-Grey or Transparent (4)
 Spray-applied base coat: White, Grey, Charcoal, Transparent
 Stain (7)
 Carefree protect (7)
 Starter's set (Nails, air vent & storm anchor set)
 Foundation beams, impregnated 300cm (7)
 Foundation beams, hardwood 300cm (7)
 Foundation beams, synthetic 300cm (7)
 Construction girders, hardwood 4.0x20.0x300cm (7)
 Hardwood stakes with point 6.0x6.0x75cm (35)
 Gutter set plastic 100mm (charcoal)
 Gutter set thermally galvanised 125mm
 Gutter plank (impr. Spruce, necessary for fitting a gutter) (6)
 Skylight (only with roofing felt and roof shingles)
 Roof covering kit (5)
 Glazing kit white
 Wooden floor 18mm (6)
 Wooden floor 18mm impregnated (6)
 Wooden floor 26mm (8)
 Wooden floor 26mm impregnated (8)
 Additional wall layer
 Finial with ball (2)

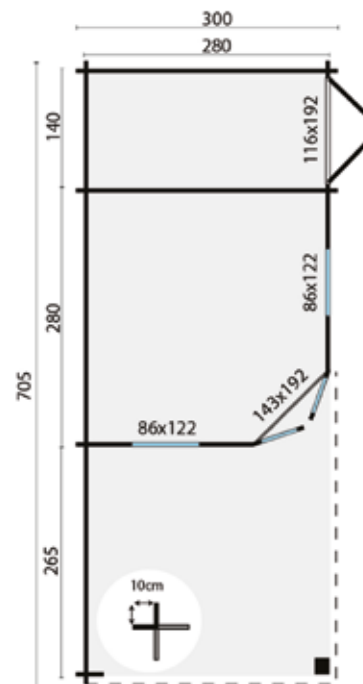

All options can be found from page 399 onwards
 Wooden floor under the Porch, see page 64 and 404

7.8m ²	31.0m ²	30.4m ³	44mm	4mm
3.9m ²				
7.4m ²				

GRETEL - LOG CABIN



Optional roof shingles, straight (36m²)
 Optional roof shingles, beavertail (36m²)
 Optional roof shingles, hexagonal (36m²)

Specifications:

- Article no..... 40.0729
- Wood thickness 44mm
- Wood type spruce, untreated
- Dimensions..... 250+540x250cm
- Foundation size 770x230cm
- Ridge height approx. 282cm
- Windows 2 (can be opened)
- Glass single glazing
- Supplied with separate bars for windows and doors
- Can also be constructed in mirror image

Optional extra's

- Impregnation: Green, Brown, Silver-Grey
- Impregnating Liquid in Green, Brown, Silver-Grey or Transparent (3)
- Spray-applied base coat: White, Grey, Charcoal, Transparent
- Stain (6)
- Carefree protect (6)
- Starter's set (Nails, air vent & storm anchor set)
- Foundation beams, impregnated 300cm (5)
- Foundation beams, hardwood 300cm (5)
- Foundation beams, synthetic 300cm (5)
- Construction girders, hardwood 4.0x20.0x300cm (5)
- Hardwood stakes with point 6.0x6.0x75cm (25)
- Gutter set plastic 100mm (charcoal)
- Gutter set thermally galvanised 125mm
- Gutter plank (impr. Spruce, necessary for fitting a gutter) (6)
- Skylight (only with roofing felt and roof shingles)
- Roof covering kit (5)
- Glazing kit white
- Wooden floor 18mm (3)
- Wooden floor 18mm impregnated (3)
- Wooden floor 26mm (4)
- Wooden floor 26mm impregnated (4)
- Additional wall layer
- Finial with ball (2)

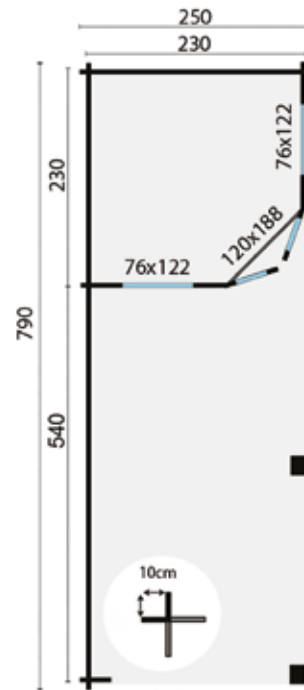

All options can be found from page 399 onwards
 Wooden floor under the Porch, see page 64 and 404

5.3m ²	29.0m ²	13.8m ³	44mm	4mm
12.4m ²				

BERTIL - LOG CABIN

Optional roof shingles, straight (42m²)
 Optional roof shingles, beavertail (42m²)
 Optional roof shingles, hexagonal (42m²)

Specifications:

Article no..... 40.0728
 Wood thickness 44mm
 Wood type spruce, untreated
 Dimensions..... 300+490x300cm
 Foundation size 770x280cm
 Ridge height approx. 292cm
 Windows 2 (can be opened)
 Glass single glazing
 Supplied with separate bars for windows and doors
 Can also be constructed in mirror image

Optional extra's

Impregnation: Green, Brown, Silver-Grey
 Impregnating Liquid in Green, Brown, Silver-Grey or Transparent (4)
 Spray-applied base coat: White, Grey, Charcoal, Transparent
 Stain (8)
 Carefree protect (8)
 Starter's set (Nails, air vent & storm anchor set)
 Foundation beams, impregnated 300cm (7)
 Foundation beams, hardwood 300cm (7)
 Foundation beams, synthetic 300cm (7)
 Construction girders, hardwood 4.0x20.0x300cm (7)
 Hardwood stakes with point 6.0x6.0x75cm (35)
 Gutter set plastic 100mm (charcoal)
 Gutter set thermally galvanised 125mm
 Gutter plank (impr. Spruce, necessary for fitting a gutter) (6)
 Skylight (only with roofing felt and roof shingles)
 Roof covering kit (6)
 Glazing kit white
 Wooden floor 18mm (4)
 Wooden floor 18mm impregnated (4)
 Wooden floor 26mm (5)
 Wooden floor 26mm impregnated (5)
 Additional wall layer
 Finial with ball (2)

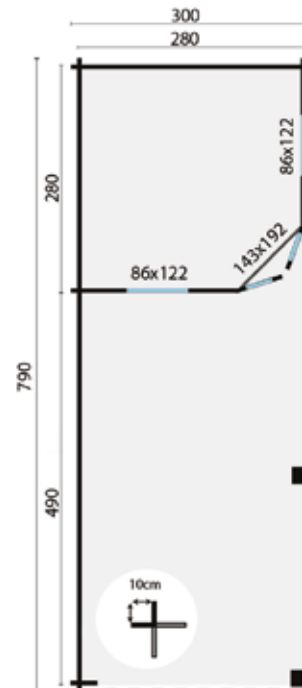

All options can be found from page 399 onwards
 Wooden floor under the Porch, see page 64 and 404

	7.8m ² 13.7m ²		35.5m ²		21.1m ³		44mm		4mm
--	---	--	--------------------	--	--------------------	--	------	--	-----

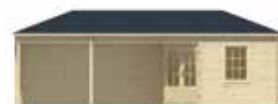
PAIVA - LOG CABIN

Optional roof shingles, straight (48m²)
 Optional roof shingles, beavertail (48m²)
 Optional roof shingles, hexagonal (48m²)

Specifications:

Article no..... 40.0727
 Wood thickness 44mm
 Wood type spruce, untreated
 Dimensions..... 350+450x350cm
 Foundation size 780x330cm
 Ridge height approx. 302cm
 Windows 2 (can be opened)
 Glass single glazing
 Supplied with separate bars for windows and doors
 Can also be constructed in mirror image

Optional extra's

Impregnation: Green, Brown, Silver-Grey
 Impregnating Liquid in Green, Brown, Silver-Grey or Transparent (4)
 Spray-applied base coat: White, Grey, Charcoal, Transparent
 Stain (8)
 Carefree protect (8)
 Starter's set (Nails, air vent & storm anchor set)
 Foundation beams, impregnated 300cm (7)
 Foundation beams, hardwood 300cm (7)
 Foundation beams, synthetic 300cm (7)
 Construction girders, hardwood 4.0x20.0x300cm (7)
 Hardwood stakes with point 6.0x6.0x75cm (35)
 Gutter set plastic 100mm (charcoal)
 Gutter set thermally galvanised 125mm
 Gutter plank (impr. Spruce, necessary for fitting a gutter) (6)
 Skylight (only with roofing felt and roof shingles)
 Roof covering kit (6)
 Glazing kit white
 Wooden floor 18mm (6)
 Wooden floor 18mm impregnated (6)
 Wooden floor 26mm (7)
 Wooden floor 26mm impregnated (7)
 Additional wall layer
 Finial with ball (2)

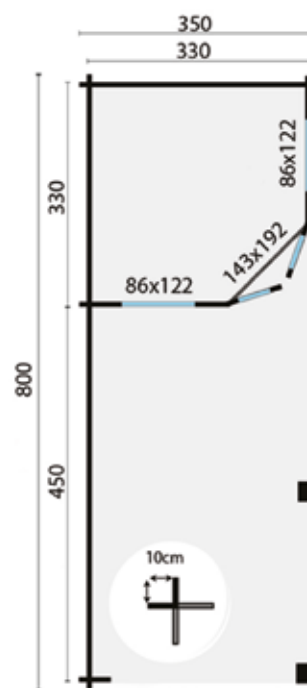

All options can be found from page 399 onwards
 Wooden floor under the Porch, see page 64 and 404

	10.9m ²		37.7m ²		29.4m ³		44mm		4mm
	14.8m ²								

ANNETTE - LOG CABIN

Optional EASY-roofing (40m²)
Optional EPDM (34m²)

Specifications:

Article no..... 40.0890
Wood thickness 40mm
Wood type spruce, untreated
Dimensions..... 300+400x300+100cm
Foundation size 680x280cm
Ridge height approx. 233cm
Windows 2 (can be opened)
Glass single glazing
Supplied with separate bars for windows and doors
Can also be constructed in mirror image

Optional extra's

Impregnation: Green, Brown, Silver-Grey
Impregnating Liquid in Green, Brown, Silver-Grey or Transparent (2)
Spray-applied base coat: White, Grey, Charcoal, Transparent
Stain (4)
Carefree protect (4)
Starter's set (Nails, air vent & storm anchor set) (2)
Foundation beams, impregnated 300cm (6)
Foundation beams, hardwood 300cm (6)
Foundation beams, synthetic 300cm (6)
Construction girders, hardwood 4.0x20.0x300cm (6)
Hardwood stakes with point 6.0x6.0x75cm (30)
Gutter set plastic 100mm (charcoal)
Gutter set thermally galvanised 125mm
Roof covering kit (5)
EPDM Adhesive
Glazing kit white
Wooden floor 18mm (4)
Wooden floor 18mm impregnated (4)
Wooden floor 26mm (5)
Wooden floor 26mm impregnated (5)
Additional wall layer
Aluminium Edging Strip (8)
Aluminium Outer Corner (4)
Roof Duct, Round (2)

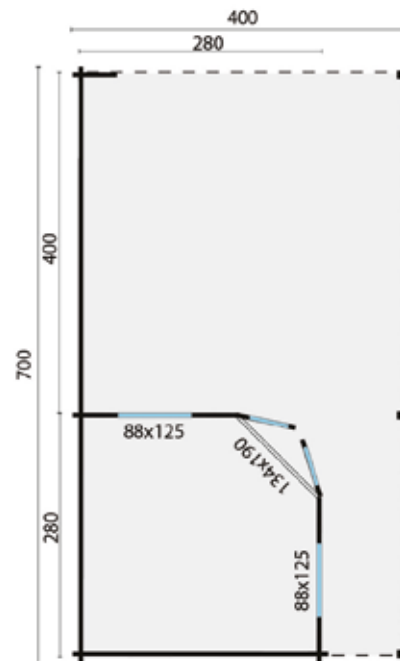

All options can be found from page 399 onwards
Wooden floor under the Porch, see page 64 and 404



OLETHA - LOG CABIN

Optional roofing felt (60m²)
 Optional EASY-roofing (60m²)
 Optional EPDM (48m²)

Specifications:

Article no..... 40.0891
 Wood thickness 40mm
 Wood type spruce, untreated
 Dimensions..... 400+385x300+210cm
 Foundation size 767x280cm
 Ridge height approx. 257cm
 Windows 3 (fixed)
 Glass double glazing
 Can also be constructed in mirror image

Optional extra's

Impregnation: Green, Brown, Silver-Grey
 Impregnating Liquid in Green, Brown, Silver-Grey or Transparent (4)
 Spray-applied base coat: White, Grey, Charcoal, Transparent
 Stain (7)
 Carefree protect (7)
 Starter's set (Nails, air vent & storm anchor set) (2)
 Foundation beams, impregnated 300cm (7)
 Foundation beams, hardwood 300cm (7)
 Foundation beams, synthetic 300cm (7)
 Construction girders, hardwood 4.0x20.0x300cm (7)
 Hardwood stakes with point 6.0x6.0x75cm (35)
 Gutter set plastic 100mm (charcoal)
 Gutter set thermally galvanised 125mm
 Roof covering kit (6)
 EPDM Adhesive
 Glazing kit white
 Wooden floor 18mm (6)
 Wooden floor 18mm impregnated (6)
 Wooden floor 26mm (7)
 Wooden floor 26mm impregnated (7)
 Additional wall layer
 Aluminium Edging Strip (10)
 Aluminium Outer Corner (4)
 Roof Duct, Round (2)



All options can be found from page 399 onwards
 Wooden floor under the Porch, see page 64 and 404

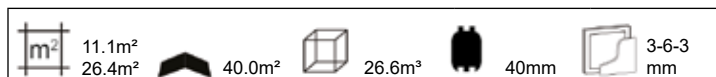

JUTKA - LOG CABIN



Optional EASY-roofing (55m²)
Optional EPDM (47m²)

Specifications:

Article no..... 40.0886
Wood thickness 44mm
Wood type spruce, untreated
Dimensions..... 380+298x380+298cm
Foundation size 658x658cm
Ridge height approx. 229cm
Windows 4 (can be opened)
Glass double glazing

Optional extra's

Impregnation: Green, Brown, Silver-Grey
Impregnating Liquid in Green, Brown, Silver-Grey or Transparent (4)
Spray-applied base coat: White, Grey, Charcoal, Transparent
Stain (7)
Carefree protect (7)
Starter's set (Nails, air vent & storm anchor set)
Foundation beams, impregnated 300cm (7)
Foundation beams, hardwood 300cm (7)
Foundation beams, synthetic 300cm (7)
Construction girders, hardwood 4.0x20.0x300cm (7)
Hardwood stakes with point 6.0x6.0x75cm (35)
EPDM Adhesive
Glazing kit white
Wooden floor 18mm (6)
Wooden floor 18mm impregnated (6)
Wooden floor 26mm (8)
Wooden floor 26mm impregnated (8)
Additional wall layer
Aluminium Edging Strip (10)
Aluminium Outer Corner (5)
Roof Duct, Round (included)

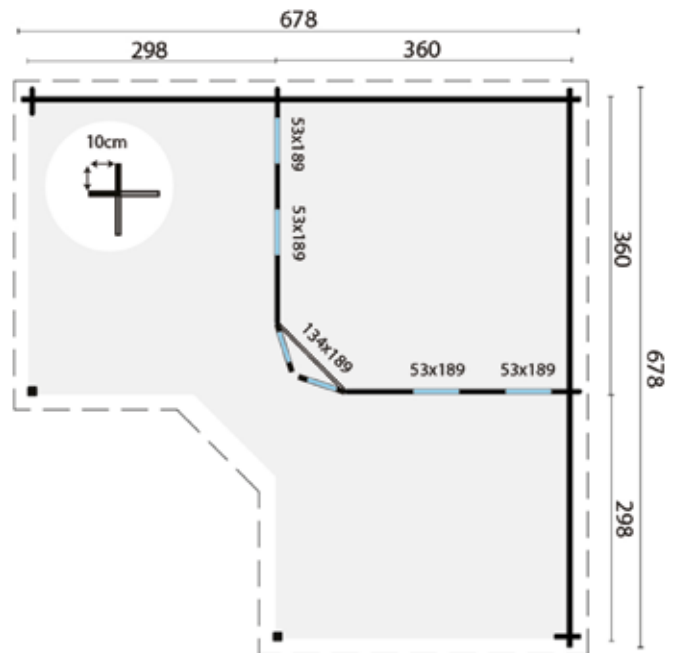

All options can be found from page 399 onwards
Wooden floor under the Porch, see page 64 and 404

	12.9m ² 10.4m ² 10.4m ²		40.4m ²		29.5m ³		44mm		3-6-3 mm
--	--	--	--------------------	--	--------------------	--	------	--	-------------

HALVAR - LOG CABIN

Optional roof shingles, straight (18m²)
 Optional roof shingles, beaver tail (18m²)
 Optional roof shingles, hexagonal (18m²)

Specifications:

Article no..... 40.0275
 Wood thickness 28mm
 Wood type spruce, untreated
 Dimensions..... 300x300cm
 Foundation size 280x280cm
 Ridge height approx. 271cm
 Windows 1 (can be opened)
 Glass single glazing
 Supplied with separate bars for windows and doors
 Side window can be placed to the left or to the right

Optional extra's

Impregnation: Green, Brown, Silver-Grey
 Impregnating Liquid in Green, Brown, Silver-Grey or Transparent (2)
 Spray-applied base coat: White, Grey, Charcoal, Transparent
 Stain (4)
 Carefree protect (4)
 Starter's set (Nails, air vent & storm anchor set)
 Foundation beams, impregnated 300cm (4)
 Foundation beams, hardwood 300cm (4)
 Foundation beams, synthetic 300cm (4)
 Construction girders, hardwood 4.0x20.0x300cm (4)
 Hardwood stakes with point 6.0x6.0x75cm (20)
 Gutter set plastic 65mm (charcoal)
 Gutter set plastic 100mm (charcoal)
 Gutter set thermally galvanised 125mm
 Gutter plank (impr. Spruce, necessary for fitting a gutter) (4)
 Roof covering kit (3)
 Glazing kit white
 Wooden floor 18mm (4)
 Wooden floor 18mm impregnated (4)
 Wooden floor 26mm (5)
 Wooden floor 26mm impregnated (5)
 Additional wall layer
 Finial with ball

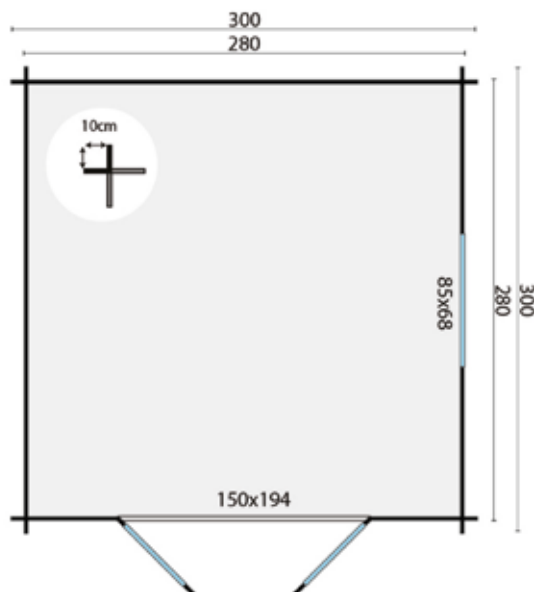

All options can be found from page 399 onwards



AKSEL - LOG CABIN



Optional roof shingles, straight (18m²)
 Optional roof shingles, beavertail (18m²)
 Optional roof shingles, hexagonal (18m²)

Optional roof tile profile boards (19m²)*
 Optional aquapan

Specifications:

Article no..... 40.7037
 Wood thickness 28mm
 Wood type spruce, untreated
 Dimensions..... 400x300cm
 Foundation size 380x280cm
 Ridge height approx. 274cm
 Windows 1 (can be opened)
 Glass single glazing
 Supplied with separate bars for windows and doors
 Doors and windows can be placed to the left or to the right
 * Tip: When fitting roof tile profile boards we recommend that you also order the wide wind stops
 The colour of the gutter planks and wind stops may differ somewhat

Optional extra's

Impregnation: Green, Brown, Silver-Grey
 Impregnating Liquid in Green, Brown, Silver-Grey or Transparent (3)
 Spray-applied base coat: White, Grey, Charcoal, Transparent
 Stain (5)
 Carefree protect (5)
 Starter's set (Nails, air vent & storm anchor set)
 Foundation beams, impregnated 300cm (5)
 Foundation beams, hardwood 300cm (5)
 Foundation beams, synthetic 300cm (5)
 Construction girders, hardwood 4.0x20.0x300cm (5)
 Hardwood stakes with point 6.0x6.0x75cm (25)
 Gutter set plastic 65mm (charcoal)
 Gutter set plastic 100mm (charcoal)
 Gutter set thermally galvanised 125mm
 Gutter plank (impr. Spruce, necessary for fitting a gutter) (3)
 Skylight (only with roofing felt and roof shingles)
 Roof covering kit (3)
 Glazing kit white
 Wooden floor 18mm (5)
 Wooden floor 18mm impregnated (5)
 Wooden floor 26mm (7)
 Wooden floor 26mm impregnated (7)
 Additional wall layer
 * Wide wind stop (impregnated spruce) (4)

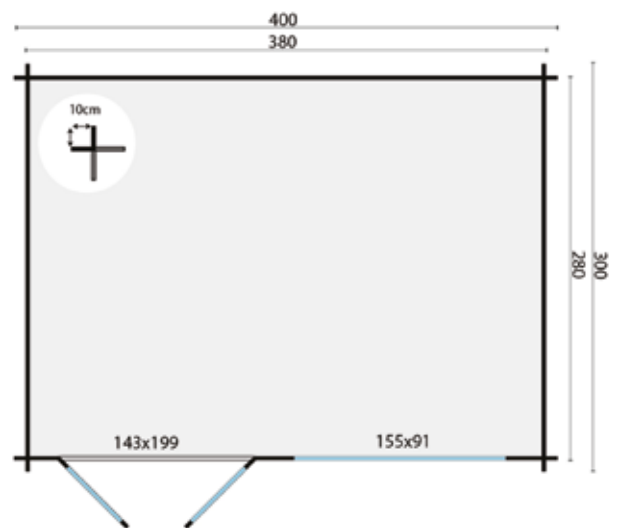

All options can be found from page 399 onwards



ARNE - LOG CABIN



Optional roof shingles, straight (24m²)
 Optional roof shingles, beavertail (24m²)
 Optional roof shingles, hexagonal (24m²)

Optional roof tile profile boards (24m²)*
 Optional aquapan

Specifications:

Article no..... 40.0737
 Wood thickness 28mm
 Wood type spruce, untreated
 Dimensions..... 450x350cm
 Foundation size 432x332cm
 Ridge height approx. 264cm
 Windows 4 (can be opened)
 Glass single glazing
 Supplied with separate bars for windows and doors

* Tip: When fitting roof tile profile boards we recommend that you also order the wide wind stops

The colour of the gutter planks and wind stops may differ somewhat

Optional extra's

- Impregnation: Green, Brown, Silver-Grey
- Impregnating Liquid in Green, Brown, Silver-Grey or Transparent (4)
- Spray-applied base coat: White, Grey, Charcoal, Transparent
- Stain (7)
- Carefree protect (7)
- Starter's set (Nails, air vent & storm anchor set)
- Foundation beams, impregnated 300cm (5)
- Foundation beams, hardwood 300cm (5)
- Foundation beams, synthetic 300cm (5)
- Construction girders, hardwood 4.0x20.0x300cm (5)
- Hardwood stakes with point 6.0x6.0x75cm (25)
- Gutter set plastic 65mm (charcoal)
- Gutter set plastic 100mm (charcoal)
- Gutter set thermally galvanised 125mm
- Gutter plank (impr. Spruce, necessary for fitting a gutter) (3)
- Skylight (only with roofing felt and roof shingles)
- Roof covering kit (4)
- Glazing kit white
- Wooden floor 18mm (8)
- Wooden floor 18mm impregnated (8)
- Wooden floor 26mm (10)
- Wooden floor 26mm impregnated (10)
- Additional wall layer
- * Wide wind stop (impragnated spruce) (8)

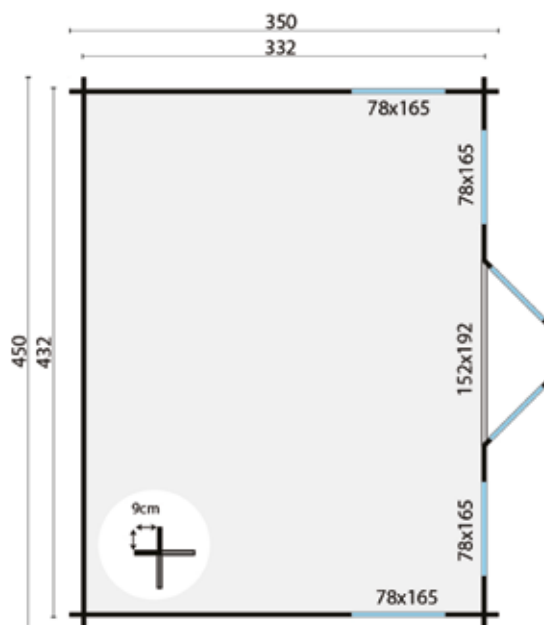

All options can be found from page 399 onwards

m² 14.3m²
18.6m²
34.3m³
28mm
4mm

DAISY - LOG CABIN

- Optional roof shingles, straight (15m²)
- Optional roof shingles, beaver tail (15m²)
- Optional roof shingles, hexagonal (15m²)

Specifications:

- Article no..... 40.7266
- Wood thickness 40mm
- Wood type spruce, untreated
- Dimensions..... 350x250cm
- Foundation size 330x230cm
- Ridge height approx. 239cm
- Windows 1 (can be opened)
- Glass double glazing
- Supplied with separate bars for windows and doors
- Doors and windows can be placed to the left or to the right
- The colour of the gutter planks and wind stops may differ somewhat

New**Optional extra's**

- Impregnation: Green, Brown, Silver-Grey
- Impregnating Liquid in Green, Brown, Silver-Grey or Transparent (2)
- Spray-applied base coat: White, Grey, Charcoal, Transparent
- Stain (4)
- Carefree protect (4)
- Starter's set (Nails, air vent & storm anchor set)
- Foundation beams, impregnated 300cm (4)
- Foundation beams, hardwood 300cm (4)
- Foundation beams, synthetic 300cm (4)
- Construction girders, hardwood 4.0x20.0x300cm (4)
- Hardwood stakes with point 6.0x6.0x75cm (20)
- Gutter set plastic 65mm (charcoal)
- Gutter set plastic 100mm (charcoal)
- Gutter set thermally galvanised 125mm
- Gutter plank (impr. Spruce, necessary for fitting a gutter) (2)
- Skylight (only with roofing felt and roof shingles)
- Roof covering kit (3)
- Glazing kit white
- Wooden floor 18mm (4)
- Wooden floor 18mm impregnated (4)
- Wooden floor 26mm (4)
- Wooden floor 26mm impregnated (4)
- Additional wall layer

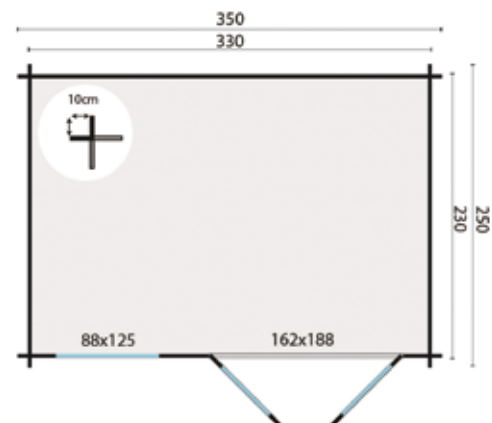

All options can be found from page 399 onwards

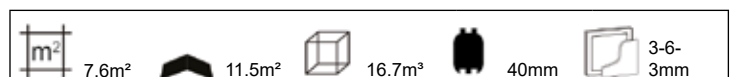

CHLOE - LOG CABIN

- Optional roof shingles, straight (21m²)
- Optional roof shingles, beavertail (21m²)
- Optional roof shingles, hexagonal (21m²)

Specifications:

Article no.....	40.7267
Wood thickness	40mm
Wood type	spruce, untreated
Dimensions.....	400x300cm
Foundation size	380x280cm
Ridge height	approx. 240cm
Windows	1 (can be opened)
Glass	double glazing

Supplied with separate bars for windows and doors

Doors and windows can be placed to the left or to the right

The colour of the gutter planks and wind stops may differ somewhat

Optional extra's

Impregnation: Green, Brown, Silver-Grey

Impregnating Liquid in Green, Brown, Silver-Grey or Transparent (3)

Spray-applied base coat: White, Grey, Charcoal, Transparent

Stain (5)

Carefree protect (5)

Starter's set (Nails, air vent & storm anchor set)

Foundation beams, impregnated 300cm (5)

Foundation beams, hardwood 300cm (5)

Foundation beams, synthetic 300cm (5)

Construction girders, hardwood 4.0x20.0x300cm (5)

Hardwood stakes with point 6.0x6.0x75cm (25)

Gutter set plastic 65mm (charcoal)

Gutter set plastic 100mm (charcoal)

Gutter set thermally galvanised 125mm

Gutter plank (impr. Spruce, necessary for fitting a gutter) (3)

Skylight (only with roofing felt and roof shingles)

Roof covering kit (3)

Glazing kit white

Wooden floor 18mm (6)

Wooden floor 18mm impregnated (6)

Wooden floor 26mm (8)

Wooden floor 26mm impregnated (8)

Additional wall layer

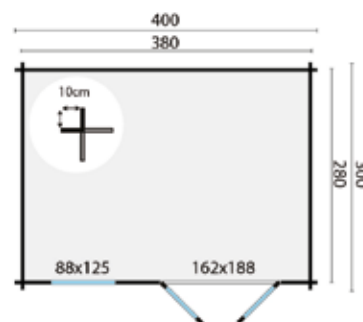
New

All options can be found from page 399 onwards



JUSTINE - LOG CABIN

Optional roof shingles, straight (21m²)
 Optional roof shingles, beavertail (21m²)
 Optional roof shingles, hexagonal (21m²)

Specifications:

Article no..... 40.7278
 Wood thickness 40mm
 Wood type spruce, untreated
 Dimensions..... 500x250cm
 Foundation size 480x230cm
 Ridge height approx. 239cm
 Windows 2 (can be opened)
 Glass double glazing
 Supplied with separate bars for windows and doors
 Doors and windows can be placed to the left or to the right
 The colour of the gutter planks and wind stops may differ somewhat

Optional extra's

Impregnation: Green, Brown, Silver-Grey
 Impregnating Liquid in Green, Brown, Silver-Grey or Transparent (3)
 Spray-applied base coat: White, Grey, Charcoal, Transparent
 Stain (5)
 Carefree protect (5)
 Starter's set (Nails, air vent & storm anchor set)
 Foundation beams, impregnated 300cm (5)
 Foundation beams, hardwood 300cm (5)
 Foundation beams, synthetic 300cm (5)
 Construction girders, hardwood 4.0x20.0x300cm (5)
 Hardwood stakes with point 6.0x6.0x75cm (25)
 Gutter set plastic 65mm (charcoal)
 Gutter set plastic 100mm (charcoal)
 Gutter set thermally galvanised 125mm
 Gutter plank (impr. Spruce, necessary for fitting a gutter) (4)
 Skylight (only with roofing felt and roof shingles)
 Roof covering kit (3)
 Glazing kit white
 Wooden floor 18mm (6)
 Wooden floor 18mm impregnated (6)
 Wooden floor 26mm (8)
 Wooden floor 26mm impregnated (8)
 Additional wall layer

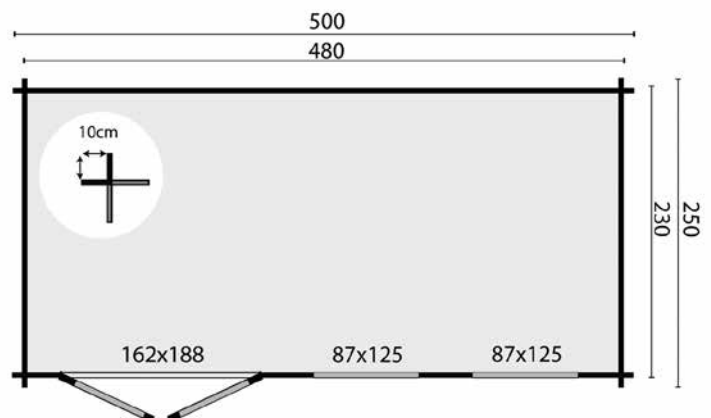
New

All options can be found from page 399 onwards

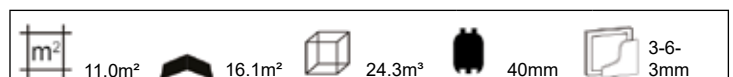

AISTE - LOG CABIN



Optional roof shingles, straight (24m²)
 Optional roof shingles, beavertail (24m²)
 Optional roof shingles, hexagonal (24m²)

Optional roof tile profile boards (24m²)*
 Optional aquapan

Specifications:

Article no..... 40.7265
 Wood thickness 40mm
 Wood type spruce, untreated
 Dimensions..... 500x300cm
 Foundation size 480x280cm
 Ridge height approx. 243cm
 Windows 2 (can be opened)
 Glass double glazing

Supplied with separate bars for windows and doors

Doors and windows can be placed to the left or to the right.

* Tip: When fitting roof tile profile boards we recommend that you also order the wide wind stops

The colour of the gutter planks and wind stops may differ somewhat

Optional extra's

- Impregnation: Green, Brown, Silver-Grey
- Impregnating Liquid in Green, Brown, Silver-Grey or Transparent (3)
- Spray-applied base coat: White, Grey, Charcoal, Transparent
- Stain (5)
- Carefree protect (5)
- Starter's set (Nails, air vent & storm anchor set)
- Foundation beams, impregnated 300cm (7)
- Foundation beams, hardwood 300cm (7)
- Foundation beams, synthetic 300cm (7)
- Construction girders, hardwood 4.0x20.0x300cm (7)
- Hardwood stakes with point 6.0x6.0x75cm (35)
- Gutter set plastic 65mm (charcoal)
- Gutter set plastic 100mm (charcoal)
- Gutter set thermally galvanised 125mm
- Gutter plank (impr. Spruce, necessary for fitting a gutter) (3)
- Skylight (only with roofing felt and roof shingles)
- Roof covering kit (4)
- Glazing kit white
- Wooden floor 18mm (7)
- Wooden floor 18mm impregnated (7)
- Wooden floor 26mm (9)
- Wooden floor 26mm impregnated (9)
- Additional wall layer
- * Wide wind stop (impregnated spruce) (4)

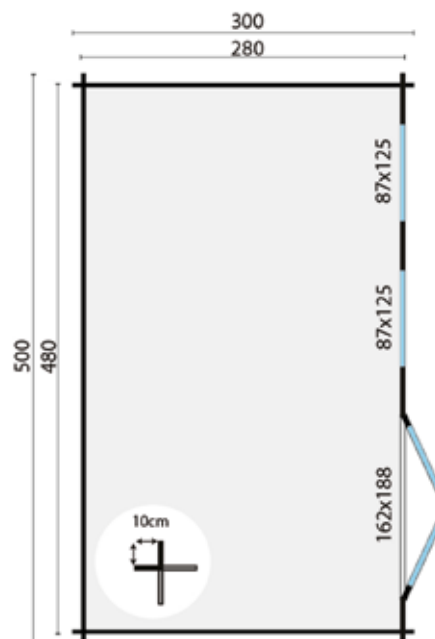

All options can be found from page 399 onwards

13.4m²
 18.6m²
 29.5m³
 40mm
 3-6-3 mm

ROIG - LOG CABIN



Optional roof shingles straight (33m²)
 Optional roof shingles beavertail (33m²)
 Optional roof shingles, hexagonal (33m²)

Specifications:

Article no..... 40.0894
 Wood thickness 28mm
 Wood type spruce, untreated
 Dimensions.....598x300cm
 Foundation size598x300cm
 Ridge height approx. 313cm

Optional extra's

Impregnation: Green, Brown, Silver-Grey
 Impregnating Liquid in Green, Brown, Silver-Grey or Transparent (2)
 Spray-applied base coat: White, Grey, Charcoal, Transparent
 Stain (3)
 Carefree protect (3)
 Starter's set (Nails, air vent & storm anchor set)
 Foundation beams, impregnated 300cm (4)
 Foundation beams, hardwood 300cm (4)
 Foundation beams, synthetic 300cm (4)
 Construction girders, hardwood 4.0x20.0x300cm (4)
 Hardwood stakes with point 6.0x6.0x75cm (20)
 Gutter set plastic 100mm (charcoal)
 Gutter set thermally galvanised 125mm
 Sinking prevention (7)
 Concrete pad footing with rounded edges (grey) (7)
 Concrete pad footing with rounded edges (charcoal) (7)
 Concrete pad footing with bevelled edges (charcoal) (7)
 Thermally galvanised height adjustment (7)
 Stainless steel height adjustment (7)
 Roof covering kit (3)

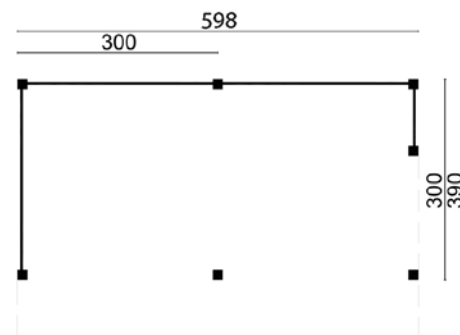

All options can be found from page 399 onwards
 Wooden floor under the Porch, see page 64 and 404

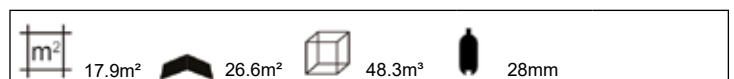

TANE - LOG CABIN



Optional roof shingles, straight (24m²)
 Optional roof shingles, beavertail (24m²)
 Optional roof shingles, hexagonal (24m²)

Optional roof tile profile boards (27m²)*

New

Specifications:

Article no..... 40.0899
 Wood thickness 40mm
 Wood type spruce, untreated
 Dimensions..... 480x350cm
 Foundation size 460x330cm
 Ridge height approx. 279cm
 Glass double glazing
 Supplied with separate bars for windows and doors
 Can also be constructed in mirror image

Optional extra's

Impregnation: Green, Brown, Silver-Grey
 Impregnating Liquid in Green, Brown, Silver-Grey or Transparent (3)
 Spray-applied base coat: White, Grey, Charcoal, Transparent Stain (5)
 Carefree protect (5)
 Starter's set (Nails, air vent & storm anchor set)
 Foundation beams, impregnated 300cm (6)
 Foundation beams, hardwood 300cm (6)
 Foundation beams, synthetic 300cm (6)
 Construction girders, hardwood 4.0x20.0x300cm (6)
 Hardwood stakes with point 6.0x6.0x75cm (30)
 Gutter set plastic 100mm (charcoal)
 Gutter set thermally galvanised 125mm
 Skylight (only with roofing felt and roof shingles)
 Roof covering kit (5)
 Glazing kit white
 Wooden floor 18mm (7)
 Wooden floor 18mm impregnated (7)
 Wooden floor 26mm (10)
 Wooden floor 26mm impregnated (10)
 Additional wall layer

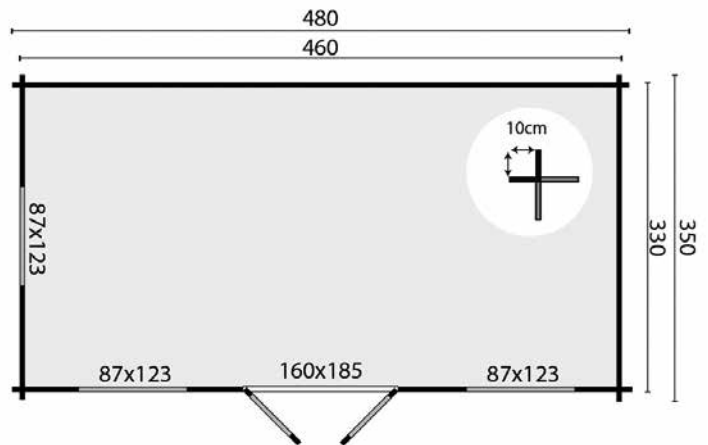

All options can be found from page 399 onwards
 Wooden floor under the Porch, see page 64 and 404

19.5m ²	19.5m ²	36.3m ³	40mm	3-6-3 mm
--------------------	--------------------	--------------------	------	----------

SELMA - LOG CABIN

Optional roof shingles, straight (30m²)
 Optional roof shingles, beavertail (30m²)
 Optional roof shingles, hexagonal (30m²)

Optional roof tile profile boards (32m²)*

Specifications:

Article no..... 40.0898
 Wood thickness 40mm
 Wood type spruce, untreated
 Dimensions..... 178+400x350cm
 Foundation size 558x330cm
 Ridge height approx. 279cm
 Glass double glazing
 Supplied with separate bars for windows and doors
 Can also be constructed in mirror image

Optional extra's

Impregnation: Green, Brown, Silver-Grey
 Impregnating Liquid in Green, Brown, Silver-Grey or Transparent (3)
 Spray-applied base coat: White, Grey, Charcoal, Transparent Stain (5)
 Carefree protect (5)
 Starter's set (Nails, air vent & storm anchor set)
 Foundation beams, impregnated 300cm (7)
 Foundation beams, hardwood 300cm (7)
 Foundation beams, synthetic 300cm (7)
 Construction girders, hardwood 4.0x20.0x300cm (7)
 Hardwood stakes with point 6.0x6.0x75cm (35)
 Gutter set plastic 100mm (charcoal)
 Gutter set thermally galvanised 125mm
 Skylight (only with roofing felt and roof shingles)
 Roof covering kit (5)
 Glazing kit white
 Wooden floor 18mm (3)
 Wooden floor 18mm impregnated (3)
 Wooden floor 26mm (4)
 Wooden floor 26mm impregnated (4)
 Additional wall layer

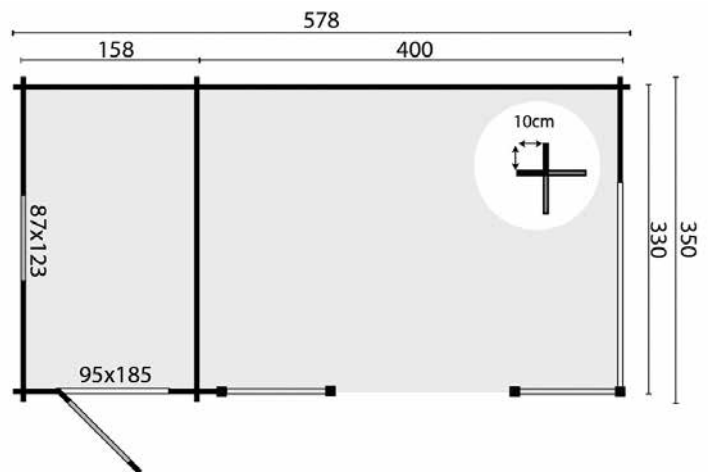
New

All options can be found from page 399 onwards
 Wooden floor under the Porch, see page 64 and 404

	4.8m ² 12.8m ²		23.3m ²		12m ³		40mm		3-6-3 mm
--	---	--	--------------------	--	------------------	--	------	--	-------------

KUKKA - LOG CABIN

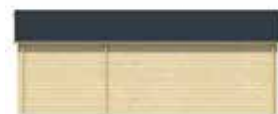

Optional roof shingles, straight (36m²)
 Optional roof shingles, beavertail (36m²)
 Optional roof shingles, hexagonal (36m²)

Optional roof tile profile boards (33m²)*

Specifications:

- Article no..... 40.0889
- Wood thickness 40mm
- Wood type spruce, untreated
- Dimensions..... 250+450x350cm
- Foundation size 680x330cm
- Ridge height approx. 279cm
- Glass double glazing
- Supplied with separate bars for windows and doors
- Can also be constructed in mirror image
- * Tip: When fitting roof tile profile boards we recommend that you also order the wide wind stops
- The colour of the gutter planks and wind stops may differ somewhat

Optional extra's

- Impregnation: Green, Brown, Silver-Grey
- Impregnating Liquid in Green, Brown, Silver-Grey or Transparent (3)
- Spray-applied base coat: White, Grey, Charcoal, Transparent
- Stain (6)
- Starter's set (Nails, air vent & storm anchor set)
- Carefree protect (6)
- Foundation beams, impregnated 300cm (7)
- Foundation beams, hardwood 300cm (7)
- Foundation beams, synthetic 300cm (7)
- Construction girders, hardwood 4.0x20.0x300cm (7)
- Hardwood stakes with point 6.0x6.0x75cm (35)
- Gutter set plastic 100mm (charcoal)
- Gutter set thermally galvanised 125mm
- Gutter plank (impr. Spruce, necessary for fitting a gutter) (4)
- Skylight (only with roofing felt and roof shingles)
- Roof covering kit (5)
- Glazing kit white
- Wooden floor 18mm (4)
- Wooden floor 18mm impregnated (4)
- Wooden floor 26mm (5)
- Wooden floor 26mm impregnated (5)
- * Wide wind stop (impregnated spruce) (6)

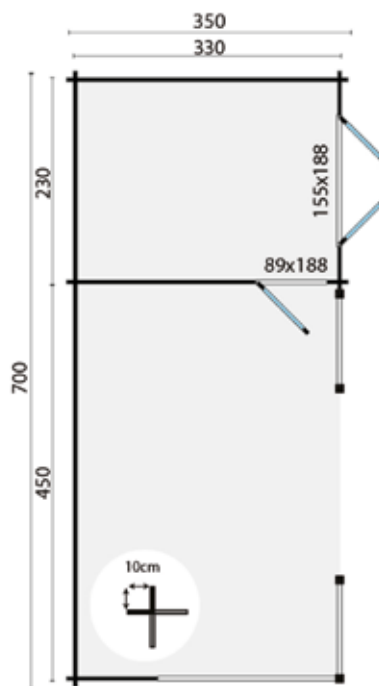

All options can be found from page 399 onwards
 Wooden floor under the Porch, see page 64 and 404

7.6m ² 14.2m ²	28.1m ²	19.7m ³	40mm	3-6-3 mm
---	--------------------	--------------------	------	----------

MOKKA - LOG CABIN



Optional roof shingles, straight (54m²)
 Optional roof shingles, beavertail (54m²)
 Optional roof shingles, hexagonal (54m²)

Optional roof tile profile boards (54m²)*

Specifications:

Article no..... 40.0893
 Wood thickness 40mm
 Wood type spruce, untreated
 Dimensions..... 400+500x400cm
 Foundation size 880x380cm
 Ridge height approx. 279cm
 Glass double glazing

Supplied with separate bars for windows and doors

Can also be constructed in mirror image

* Tip: When fitting roof tile profile boards we recommend that you also order the wide wind stops

The colour of the gutter planks and wind stops may differ somewhat

Optional extra's

Impregnation: Green, Brown, Silver-Grey
 Impregnating Liquid in Green, Brown, Silver-Grey or Transparent (4)
 Spray-applied base coat: White, Grey, Charcoal, Transparent
 Stain (8)
 Carefree protect (8)
 Starter's set (Nails, air vent & storm anchor set)
 Foundation beams, impregnated 300cm (10)
 Foundation beams, hardwood 300cm (10)
 Foundation beams, synthetic 300cm (10)
 Construction girders, hardwood 4.0x20.0x300cm (10)
 Hardwood stakes with point 6.0x6.0x75cm (50)
 Gutter set plastic 100mm (charcoal)
 Gutter set thermally galvanised 125mm
 Gutter plank (impr. Spruce, necessary for fitting a gutter) (5)
 Skylight (only with roofing felt and roof shingles)
 Roof covering kit (6)
 Glazing kit white
 Wooden floor 18mm (8)
 Wooden floor 18mm impregnated (8)
 Wooden floor 26mm (10)
 Wooden floor 26mm impregnated (10)
 Additional wall layer
 * Wide wind stop (impregnated spruce) (6)

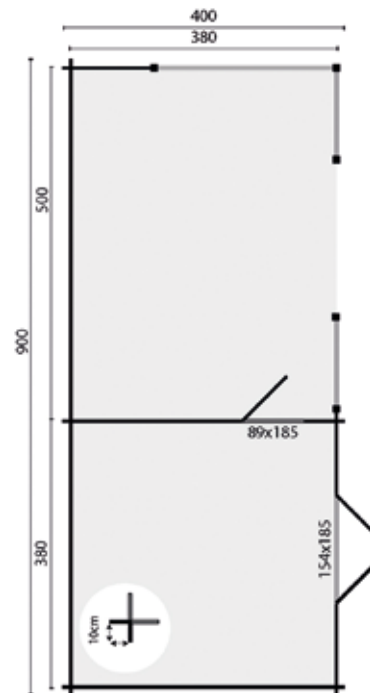

All options can be found from page 399 onwards
 Wooden floor under the Porch, see page 64 and 404

	13.8m ² 18.4m ²		38.5m ²		35.9m ³		40mm		3-6-3 mm
--	--	--	--------------------	--	--------------------	--	------	--	----------

OVE - LOG CABIN



Optional roofing felt (32.5m²)
 Optional roof shingles, straight (27m²)
 Optional roof shingles, beavertail (27m²)

Optional roof shingles, hexagonal (27m²)
 Optional roof tile profile boards (29m²)*
 Optional aquapan

Specifications:

Article no..... 40.0881
 Wood thickness 28mm
 Wood type spruce, untreated
 Dimensions..... 250+340x300cm
 Foundation size 570x280cm
 Ridge height approx. 276cm
 Glass single glazing

Supplied with fixed bars for the doors

Can also be constructed in mirror image

When using a gutter an extra wall layer is necessary

* Tip: When fitting roof tile profile boards we recommend that you also order the wide wind stops

The colour of the gutter planks and wind stops may differ somewhat

Optional extra's

- Impregnation: Green, Brown, Silver-Grey
- Impregnating Liquid in Green, Brown, Silver-Grey or Transparent (3)
- Spray-applied base coat: White, Grey, Charcoal, Transparent
- Stain (5)
- Carefree protect (5)
- Starter's set (Nails, air vent & storm anchor set)
- Foundation beams, impregnated 300cm (5)
- Foundation beams, hardwood 300cm (5)
- Foundation beams, synthetic 300cm (5)
- Construction girders, hardwood 4.0x20.0x300cm (5)
- Hardwood stakes with point 6.0x6.0x75cm (25)
- Gutter set plastic 65mm (charcoal)
- Gutter set plastic 100mm (charcoal)
- Gutter set thermally galvanised 125mm
- Gutter plank (impr. Spruce, necessary for fitting a gutter) (4)
- Skylight (only with roofing felt and roof shingles)
- Roof covering kit (5)
- Glazing kit white
- Wooden floor 18mm (4)
- Wooden floor 18mm impregnated (4)
- Wooden floor 26mm (5)
- Wooden floor 26mm impregnated (5)
- Additional wall layer

* Wide wind stop (impregnated spruce) (4)

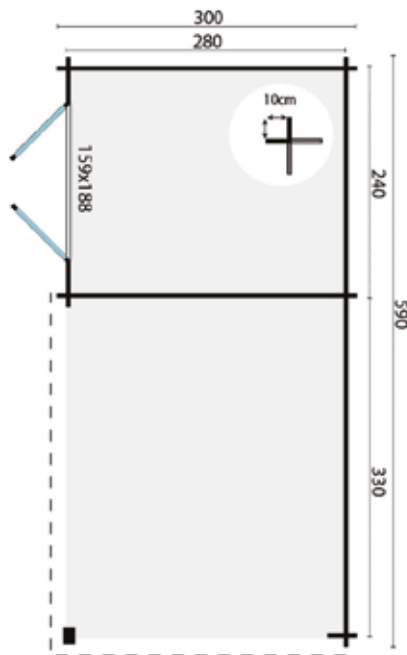

All options can be found from page 399 onwards
 Wooden floor under the Porch, see page 64 and 404

6.7m ²	20.1m ²	14.9m ³	28mm	4mm
9.2m ²				

KWASPA - LOG CABIN

Optional roof shingles, straight (42m²)
 Optional roof shingles, beavertail (42m²)
 Optional roof shingles, hexagonal (42m²)

Optional roof tile profile boards (38m²)*
 Optional aquapan

Specifications:

Article no..... 40.0804
 Wood thickness 44mm
 Wood type spruce, untreated
 Dimensions..... 400x400x400cm
 Foundation size 780x380cm
 Ridge height approx. 299cm
 Windows 2 (can be opened)
 Glass single glazing

Supplied with fixed bars for windows and doors

Can also be constructed in mirror image

* Tip: When fitting roof tile profile boards we recommend that you also order the wide wind stops

The colour of the gutter planks and wind stops may differ somewhat

Optional extra's

Impregnation: Green, Brown, Silver-Grey
 Impregnating Liquid in Green, Brown, Silver-Grey or Transparent (4)
 Spray-applied base coat: White, Grey, Charcoal, Transparent
 Stain (7)
 Carefree protect (7)
 Starter's set (Nails, air vent & storm anchor set)
 Foundation beams, impregnated 300cm (7)
 Foundation beams, hardwood 300cm (7)
 Foundation beams, synthetic 300cm (7)
 Construction girders, hardwood 4.0x20.0x300cm (7)
 Hardwood stakes with point 6.0x6.0x75cm (35)
 Gutter set plastic 100mm (charcoal)
 Gutter set thermally galvanised 125mm
 Gutter plank (impr. Spruce, necessary for fitting a gutter) (5)
 Skylight (only with roofing felt and roof shingles)
 Roof covering kit (5)
 Glazing kit white
 Wooden floor 18mm (7)
 Wooden floor 18mm impregnated (7)
 Wooden floor 26mm (9)
 Wooden floor 26mm impregnated (9)
 Additional wall layer
 * Wide wind stop (impregnated spruce) (8)

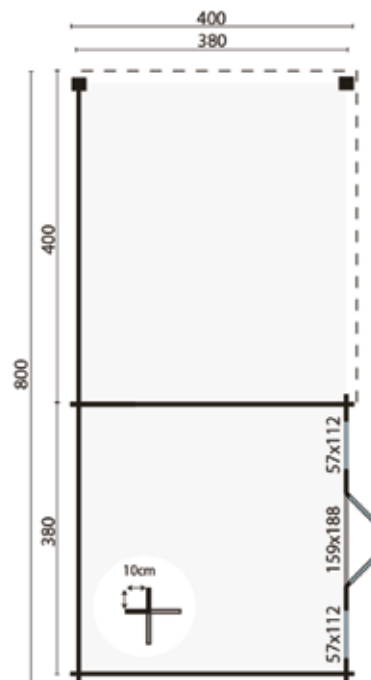

All options can be found from page 399 onwards
 Wooden floor under the Porch, see page 64 and 404

	14.4m ²		36.1m ²		43.0m ³		44mm		4mm
	14.4m ²								

JOHAN - LOG CABIN



Optional roof shingles, straight (27m²)
 Optional roof shingles, beavertail (27m²)
 Optional roof shingles, hexagonal (27m²)

Optional roof tile profile boards (29m²)*
 Optional aquapan

Specifications:

Article no..... 40.0738
 Wood thickness 34mm
 Wood type spruce, untreated
 Dimensions.....500x410cm
 Foundation size482x392cm
 Ridge height approx. 270cm
 Windows 2 (can be opened)
 Glass single glazing
 Supplied with separate bars for windows and doors
 Can also be constructed in mirror image
 * Tip: When fitting roof tile profile boards we recommend that you also order the wide wind stops
 The colour of the gutter planks and wind stops may differ somewhat

Optional extra's

- Impregnation: Green, Brown, Silver-Grey
- Impregnating Liquid in Green, Brown, Silver-Grey or Transparent (3)
- Spray-applied base coat: White, Grey, Charcoal, Transparent Stain (5)
- Carefree protect (5)
- Starter's set (Nails, air vent & storm anchor set)
- Foundation beams, impregnated 300cm (6)
- Foundation beams, hardwood 300cm (6)
- Foundation beams, synthetic 300cm (6)
- Construction girders, hardwood 4.0x20.0x300cm (6)
- Hardwood stakes with point 6.0x6.0x75cm (30)
- Gutter set plastic 65mm (charcoal)
- Gutter set plastic 100mm (charcoal)
- Gutter set thermally galvanised 125mm
- Gutter plank (impr. Spruce, necessary for fitting a gutter) (4)
- Skylight (only with roofing felt and roof shingles)
- Roof covering kit (4)
- Glazing kit white
- Wooden floor 18mm (8)
- Wooden floor 18mm impregnated (8)
- Wooden floor 26mm (10)
- Wooden floor 26mm impregnated (10)
- Additional wall layer
- * Wide wind stop (impregnated spruce) (8)

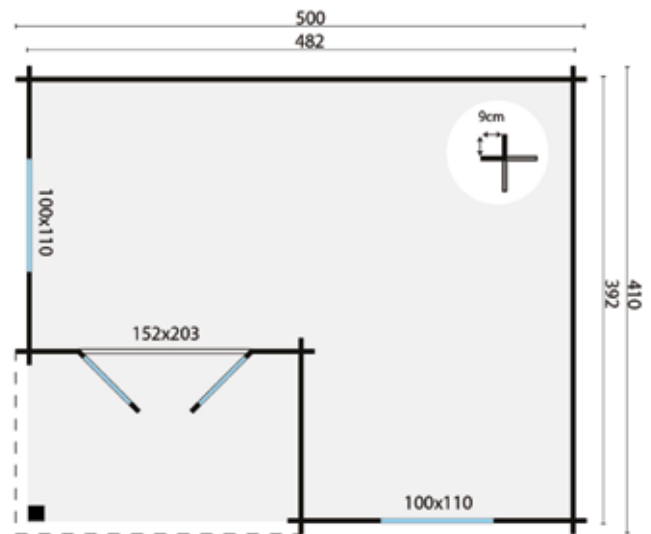

All options can be found from page 399 onwards
 Wooden floor under the Porch, see page 64 and 404

16.5m²
23.8m²
41.2m³
34mm
4mm

GU DRUN - LOG CABIN

Optional roof shingles, straight (36m²)
 Optional roof shingles, beavertail (36m²)
 Optional roof shingles, hexagonal (36m²)

Specifications:

Article no..... 40.0814
 Wood thickness 44mm
 Wood type spruce, untreated
 Dimensions..... 503x360cm
 Foundation size 503x360cm
 Ridge height approx. 339cm
 Harmonica doors 247cm wide
 Windows 2 (can be opened)
 Glass double glazing
 Storm bar included
 Supplied with separate bars for windows and doors

Optional extra's

Impregnation: Green, Brown, Silver-Grey
 Impregnating Liquid in Green, Brown, Silver-Grey or Transparent (3)
 Spray-applied base coat: White, Grey, Charcoal, Transparent
 Stain (5)
 Carefree protect (5)
 Starter's set (Nails, air vent & storm anchor set)
 Foundation beams, impregnated 300cm (7)
 Foundation beams, hardwood 300cm (7)
 Foundation beams, synthetic 300cm (7)
 Construction girders, hardwood 4.0x20.0x300cm (7)
 Hardwood stakes with point 6.0x6.0x75cm (35)
 Skylight (only with roofing felt and roof shingles)
 Roof covering kit (4)
 Glazing kit white
 Wooden floor 18mm (8)
 Wooden floor 18mm impregnated (8)
 Wooden floor 26mm (10)
 Wooden floor 26mm impregnated (10)
 Additional wall layer

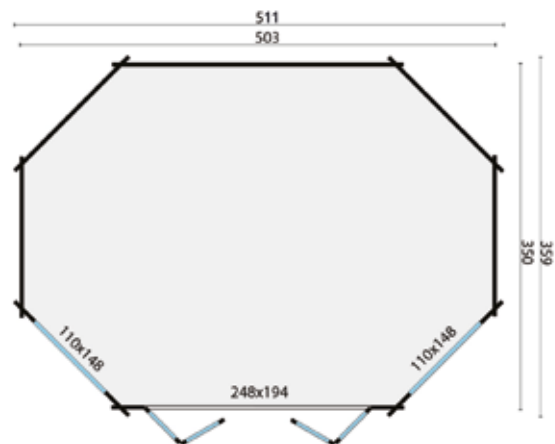

All options can be found from page 399 onwards

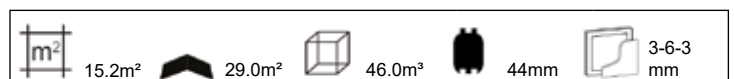

TORHEL - LOG CABIN

Optional roof shingles, straight (42m²)

Optional roof shingles, beavertail (42m²)

Optional roof shingles, hexagonal (42m²)

Specifications:

Article no..... 40.0711
 Wood thickness 44mm
 Wood type spruce, untreated
 Dimensions..... 420+280x420cm
 Foundation size 680x400cm
 Ridge height approx. 317cm
 Harmonica doors 260cm wide
 Windows 1 (can be opened)
 Glass double glazing
 Supplied with separate bars for windows and doors

Optional extra's

Impregnation: Green, Brown, Silver-Grey
 Impregnating Liquid in Green, Brown, Silver-Grey or Transparent (4)
 Spray-applied base coat: White, Grey, Charcoal, Transparent
 Stain (7)
 Carefree protect (7)
 Starter's set (Nails, air vent & storm anchor set)
 Foundation beams, impregnated 300cm (8)
 Foundation beams, hardwood 300cm (8)
 Foundation beams, synthetic 300cm (8)
 Construction girders, hardwood 4.0x20.0x300cm (8)
 Hardwood stakes with point 6.0x6.0x75cm (40)
 Gutter set plastic 100mm (charcoal)
 Gutter plank (impr. Spruce, necessary for fitting a gutter) (4)
 Roof covering kit (5)
 Glazing kit white
 Wooden floor 18mm (9)
 Wooden floor 18mm impregnated (9)
 Wooden floor 26mm (11)
 Wooden floor 26mm impregnated (11)
 Additional wall layer

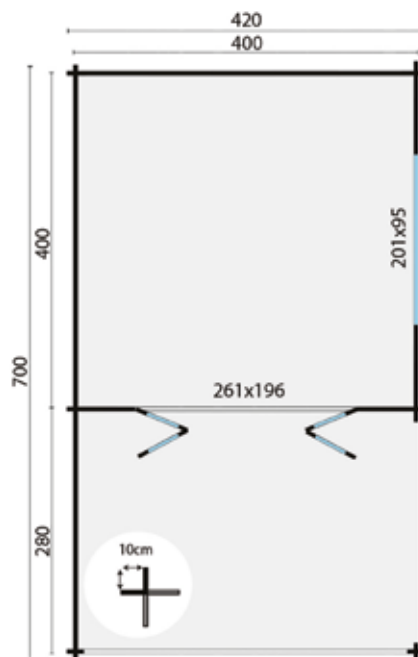

All options can be found from page 399 onwards
 Wooden floor under the Porch, see page 64 and 404

	16.0m ² 11.2m ²		34.9m ³		44mm		3-6-3 mm
--	--	--	--------------------	--	------	--	-------------

VIVEKA - LOG CABIN



Optional roof shingles, straight (45m²)
 Optional roof shingles, beavertail (45m²)
 Optional roof shingles, hexagonal (45m²)

Specifications:

Article no..... 40.0712
 Wood thickness 44mm
 Wood type spruce, untreated
 Dimensions..... 320+150+280x420cm
 Foundation size 730x400cm
 Ridge height approx. 317cm
 Harmonica doors 260cm wide
 Windows 1 (can be opened)
 Glass double glazing
 Supplied with separate bars for windows and doors

Optional extra's

Impregnation: Green, Brown, Silver-Grey
 Impregnating Liquid in Green, Brown, Silver-Grey or Transparent (5)
 Spray-applied base coat: White, Grey, Charcoal, Transparent
 Stain (9)
 Carefree protect (9)
 Starter's set (Nails, air vent & storm anchor set)
 Foundation beams, impregnated 300cm (10)
 Foundation beams, hardwood 300cm (10)
 Foundation beams, synthetic 300cm (10)
 Construction girders, hardwood 4.0x20.0x300cm (10)
 Hardwood stakes with point 6.0x6.0x75cm (50)
 Gutter set plastic 100mm (charcoal)
 Gutter plank (impr. Spruce, necessary for fitting a gutter) (4)
 Roof covering kit (6)
 Glazing kit white
 Wooden floor 18mm (9)
 Wooden floor 18mm impregnated (9)
 Wooden floor 26mm (12)
 Wooden floor 26mm impregnated (12)
 Additional wall layer

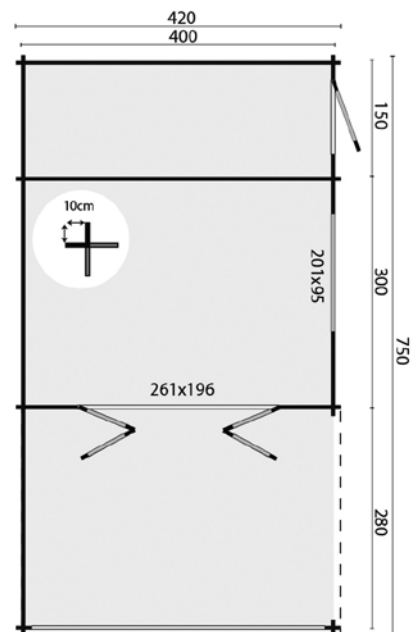

All options can be found from page 399 onwards
 Wooden floor under the Porch, see page 64 and 404

	12.0m ² 6.0m ² 11.2m ²		37.3m ²		48.6m ³		44mm		3-6-3 mm
--	---	--	--------------------	--	--------------------	--	------	--	-------------

SIBELLA - LOG CABIN

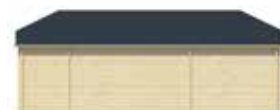

- Optional roof shingles, straight (48m²)
- Optional roof shingles, beavertail (48m²)
- Optional roof shingles, hexagonal (48m²)

Specifications:

Article no..... 40.0713
 Wood thickness 44mm
 Wood type spruce, untreated
 Dimensions..... 420+150+280x420cm
 Foundation size 830x400cm
 Ridge height approx. 317cm
 Harmonica doors 260cm wide
 Windows 1 (can be opened)
 Glass double glazing
 Supplied with separate bars for windows and doors

Optional extra's

- Impregnation: Green, Brown, Silver-Grey
- Impregnating Liquid in Green, Brown, Silver-Grey or Transparent (5)
- Spray-applied base coat: White, Grey, Charcoal, Transparent
- Stain (10)
- Carefree protect (10)
- Starter's set (Nails, air vent & storm anchor set)
- Foundation beams, impregnated 300cm (10)
- Foundation beams, hardwood 300cm (10)
- Foundation beams, synthetic 300cm (10)
- Construction girders, hardwood 4.0x20.0x300cm (10)
- Hardwood stakes with point 6.0x6.0x75cm (50)
- Gutter set plastic 100mm (charcoal)
- Gutter plank (impr. Spruce, necessary for fitting a gutter) (5)
- Roof covering kit (6)
- Glazing kit white
- Wooden floor 18mm (11)
- Wooden floor 18mm impregnated (11)
- Wooden floor 26mm (14)
- Wooden floor 26mm impregnated (14)
- Additional wall layer

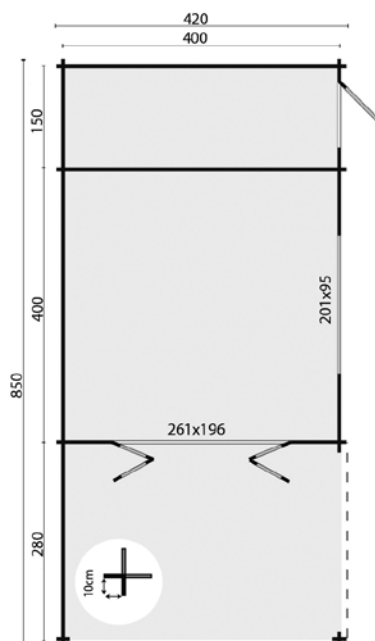

All options can be found from page 399 onwards
 Wooden floor under the Porch, see page 64 and 404

16.0m ²	42.1m ²	59.4m ³	44mm	3-6-3 mm
6.0m ²				
11.2m ²				

CLOCKHOUSE - LOG CABIN

- Optional roof shingles, straight (45m²)
- Optional roof shingles, beavertail (45m²)
- Optional roof shingles, hexagonal (45m²)

Specifications:

Article no..... 40.0809
 Wood thickness 44mm
 Wood type spruce, untreated
 Dimensions..... 550x400cm
 Foundation size 530x380cm
 Ridge height approx. 351cm
 Windows 8 (can be opened)
 Glass double glazing
 Supplied excluding clock
 Supplied with separate bars for windows and doors
 When using a gutter an extra wall layer is necessary

Optional extra's

Impregnation: Green, Brown, Silver-Grey
 Impregnating Liquid in Green, Brown, Silver-Grey or Transparent (5)
 Spray-applied base coat: White, Grey, Charcoal, Transparent
 Stain (9)
 Carefree protect (9)
 Starter's set (Nails, air vent & storm anchor set)
 Foundation beams, impregnated 300cm (7)
 Foundation beams, hardwood 300cm (7)
 Foundation beams, synthetic 300cm (7)
 Construction girders, hardwood 4.0x20.0x300cm (7)
 Hardwood stakes with point 6.0x6.0x75cm (35)
 Gutter set plastic 65mm (charcoal)
 Gutter set plastic 100mm (charcoal)
 Gutter set thermally galvanised 125mm
 Gutter plank (impr. Spruce, necessary for fitting a gutter) (3)
 Skylight (only with roofing felt and roof shingles)
 Roof covering kit (5)
 Glazing kit white
 Wooden floor 18mm (10)
 Wooden floor 18mm impregnated (10)
 Wooden floor 26mm (13)
 Wooden floor 26mm impregnated (13)
 Additional wall layer

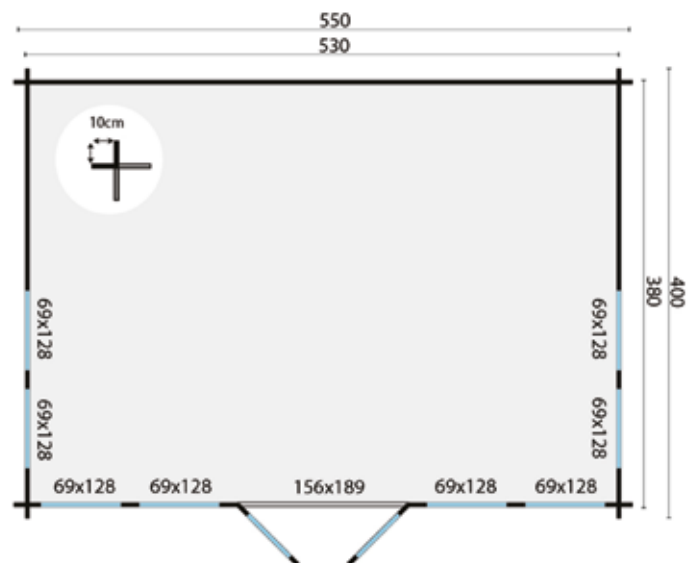

All options can be found from page 399 onwards

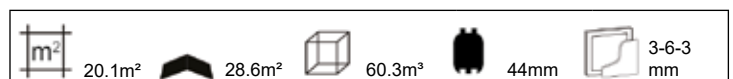

CLOCKHOUSE TREVOR - LOG CABIN



Optional roof shingles, straight (45m²)
 Optional roof shingles, beavertail (45m²)
 Optional roof shingles, hexagonal (45m²)

Specifications:

Article no..... 40.0867
 Wood thickness 70mm
 Wood type spruce, untreated
 Dimensions..... 550x400cm
 Foundation size 530x380cm
 Ridge height approx. 351cm
 Windows 8 (can be opened)
 Glass Double glazing
 Wooden floor (27mm) and foundation included
 Roofboards 27mm (ideal for insulation)..... included
 Supplied with separate bars for windows and doors
 When using a gutter an extra wall layer is necessary

Optional extra's

- Impregnation: Green, Brown, Silver-Grey
- Impregnating Liquid in Green, Brown, Silver-Grey or Transparent (5)
- Spray-applied base coat: White, Grey, Charcoal, Transparent
- Stain (9)
- Carefree protect (9)
- Starter's set (Nails, air vent & storm anchor set)
- Gutter set plastic 65mm (charcoal)
- Gutter set plastic 100mm (charcoal)
- Gutter set thermally galvanised 125mm
- Gutter plank (impr. Spruce, necessary for fitting a gutter) (3)
- Skylight (only with roofing felt and roof shingles)
- Roof covering kit (5)
- Glazing kit white
- Additional wall layer

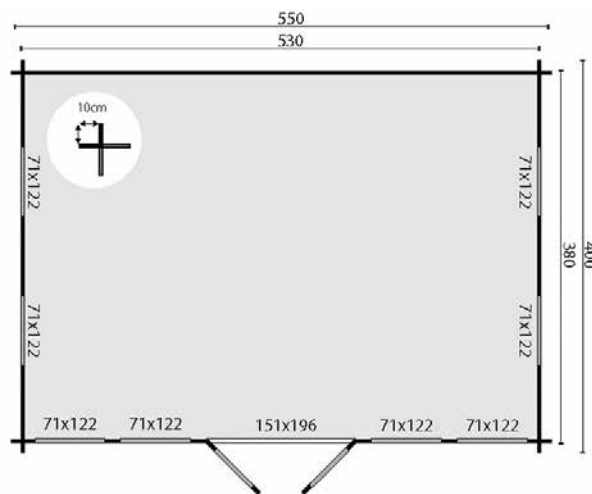

All options can be found from page 399 onwards

m² 20.1m²
28.6m²
60.3m³
70mm
3-6-3 mm

BIG LAUREN - LOG CABIN



- Optional roof shingles, straight (54m²)
- Optional roof shingles, beavertail (54m²)
- Optional roof shingles, hexagonal (54m²)

Specifications:

Article no..... 40.0823
 Wood thickness 70mm
 Wood type spruce, untreated
 Dimensions..... 930x400cm
 Foundation size 910x380cm
 Ridge height approx. 351cm
 Windows 10 (can be opened)
 Glass double glazing
 Wooden floor (27mm) and foundation included
 Roofboards 27mm (ideal for insulation)..... included
 Supplied with separate bars for windows and doors
When using a gutter an extra wall layer is necessary

Optional extra's

- Luxury windows and exterior doors
- Impregnation: Green, Brown, Silver-Grey
- Impregnating Liquid in Green, Brown, Silver-Grey or Transparent (6)
- Spray-applied base coat: White, Grey, Charcoal, Transparent
- Stain (11)
- Carefree protect (11)
- Starter's set (Nails, air vent & storm anchor set)
- Gutter set plastic 100mm (charcoal)
- Gutter set thermally galvanised 125mm
- Gutter plank (impr. Spruce, necessary for fitting a gutter) (5)
- Skylight (only with roofing felt and roof shingles)
- Roof covering kit (6)
- Additional wall layer
- Glazing kit white

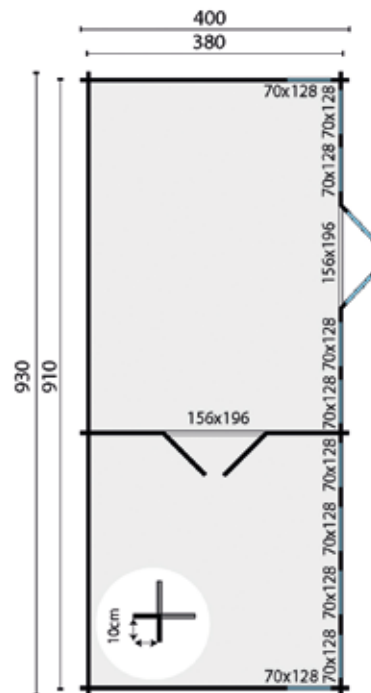

	Standard	Luxury
Wood	Pine laminated	Pine laminated
Window frame thickness	54mm	54mm
Door frame thickness	42mm	54mm
Window glazing	4/14/4mm	4/14/4mm
Door glazing	4/8/4mm	4/14/4mm
Window water gutter	Aluminium	Aluminium
Window opening system	Tilt and turn (2-hand system)	Tilt and turn (1-hand system)
Door lock	Cylinder lock	3 point lock

13.6m² / 18.8m²
 47.7m²
 97.8m³
 70mm
 4-14-4 mm

All options can be found from page 399 onwards

BIG BEN - LOG CABIN

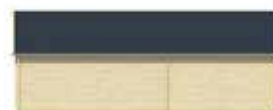

- Optional roof shingles, straight (57m²)
- Optional roof shingles, beavertail (57m²)
- Optional roof shingles, hexagonal (57m²)

Specifications:

Article no..... 40.0820
 Wood thickness 70mm
 Wood type spruce, untreated
 Dimensions..... 550+380x400cm
 Foundation size910x380cm
 Ridge height approx. 351cm
 Windows 8 (can be opened)
 Glass double glazing

Supplied with separate bars for windows and doors
 Can also be constructed in mirror image
 When using a gutter an extra wall layer is necessary

Optional extra's

- Luxury windows and exterior doors
- Impregnation: Green, Brown, Silver-Grey
- Impregnating Liquid in Green, Brown, Silver-Grey or Transparent (5)
- Spray-applied base coat: White, Grey, Charcoal, Transparent
- Stain (10)
- Carefree protect (10)
- Starter's set (Nails, air vent & storm anchor set)
- Foundation beams, impregnated 300cm (9)
- Foundation beams, hardwood 300cm (9)
- Foundation beams, synthetic 300cm (9)
- Construction girders, hardwood 4.0x20.0x300cm (9)
- Hardwood stakes with point 6.0x6.0x75cm (45)
- Gutter set plastic 100mm (charcoal)
- Gutter set thermally galvanised 125mm
- Gutter plank (impr. Spruce, necessary for fitting a gutter) (5)
- Skylight (only with roofing felt and roof shingles)
- Roof covering kit (8)
- Glazing kit white
- Wooden floor 18mm (10)
- Wooden floor 18mm impregnated (10)
- Wooden floor 26mm (13)
- Wooden floor 26mm impregnated (13)
- Additional wall layer

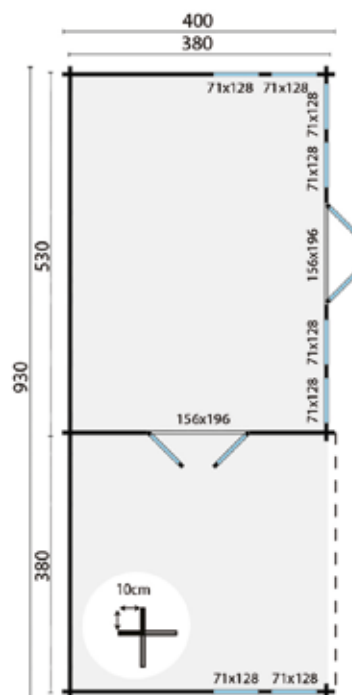

	Standard	Luxury
Wood	Pine laminated	Pine laminated
Window frame thickness	54mm	54mm
Door frame thickness	42mm	54mm
Window glazing	4/14/4mm	4/14/4mm
Door glazing	4/8/4mm	4/14/4mm
Window water gutter	Aluminium	Aluminium
Window opening system	Tilt and turn (2-hand system)	Tilt and turn (1-hand system)
Door lock	Cylinder lock	3 point lock



All options can be found from page 399 onwards
 Wooden floor under the Porch, see page 64 and 404

20.1m²
14.0m²
47.7m²
60.3m³
70mm
4-14-4 mm

OLAUG - LOG CABIN

Optional roof shingles, straight (45m²)
 Optional roof shingles, beavertail (45m²)
 Optional roof shingles, hexagonal (45m²)

Optional roof tile profile boards (44m²)*
 Optional aquapan

Specifications:

Article no..... 40.0807
 Wood thickness 44mm
 Wood type spruce, untreated
 Dimensions..... 550x400+198cm
 Foundation size 530x578cm
 Ridge height approx. 391cm
 Harmonica doors 260cm wide
 Windows 4 (can be opened)
 Glass double glazing

* Tip: When fitting roof tile profile boards we recommend that you also order the wide wind stops

The colour of the gutter planks and wind stops may differ somewhat

Optional extra's

Impregnation: Green, Brown, Silver-Grey
 Impregnating Liquid in Green, Brown, Silver-Grey or Transparent (4)
 Spray-applied base coat: White, Grey, Charcoal, Transparent
 Stain (8)
 Carefree protect (8)
 Starter's set (Nails, air vent & storm anchor set)
 Foundation beams, impregnated 300cm (8)
 Foundation beams, hardwood 300cm (8)
 Foundation beams, synthetic 300cm (8)
 Construction girders, hardwood 4.0x20.0x300cm (8)
 Hardwood stakes with point 6.0x6.0x75cm (40)
 Gutter set plastic 100mm (charcoal)
 Gutter set thermally galvanised 125mm
 Skylight (only with roofing felt and roof shingles)
 Gutter plank (impr. Spruce, necessary for fitting a gutter) (3)
 Roof covering kit (5)
 Glazing kit white
 Wooden floor 18mm (10)
 Wooden floor 18mm impregnated (10)
 Wooden floor 26mm (13)
 Wooden floor 26mm impregnated (13)
 * Wide wind stop (impregnated spruce) (8)

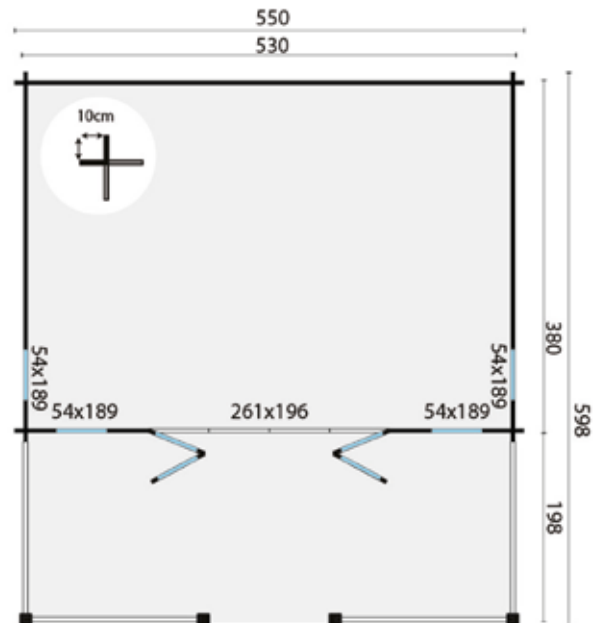

All options can be found from page 399 onwards
 Wooden floor under the Porch, see page 64 and 404

	20.1m ² 10.5m ²		41.7m ²		60.3m ³		44mm		3-6-3 mm
--	--	--	--------------------	--	--------------------	--	------	--	-------------

RAGNA - LOG CABIN

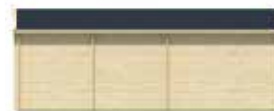

Optional roof shingles, straight (39m²)
 Optional roof shingles, beavertail (39m²)
 Optional roof shingles, hexagonal (39m²)

Optional roof tile profile boards (40m²)*
 Optional aquapan

Specifications:

Article no..... 40.0806
 Wood thickness 40mm
 Wood type spruce, untreated
 Dimensions..... 320+400x320+100cm
 Foundation size 700x400cm
 Ridge height approx. 262cm
 Windows 2 (can be opened)
 Glass single glazing

Supplied with separate bars for windows and doors
 Doors and windows can be placed to the left or to the right.
 * Tip: When fitting roof tile profile boards we recommend that you also order the wide wind stops
 The colour of the gutter planks and wind stops may differ somewhat

Optional extra's

- Impregnation: Green, Brown, Silver-Grey
- Impregnating Liquid in Green, Brown, Silver-Grey or Transparent (3)
- Spray-applied base coat: White, Grey, Charcoal, Transparent
- Stain (6)
- Carefree protect (6)
- Starter's set (Nails, air vent & storm anchor set)
- Foundation beams, impregnated 300cm (6)
- Foundation beams, hardwood 300cm (6)
- Foundation beams, synthetic 300cm (6)
- Construction girders, hardwood 4.0x20.0x300cm (6)
- Hardwood stakes with point 6.0x6.0x75cm (30)
- Gutter set plastic 100mm (charcoal)
- Gutter set thermally galvanised 125mm
- Gutter plank (impr. Spruce, necessary for fitting a gutter) (4)
- Skylight (only with roofing felt and roof shingles)
- Roof covering kit (5)
- Glazing kit white
- Wooden floor 18mm (5)
- Wooden floor 18mm impregnated (5)
- Wooden floor 26mm (6)
- Wooden floor 26mm impregnated (6)
- Additional wall layer
- * Wide wind stop (impragnated spruce) (8)

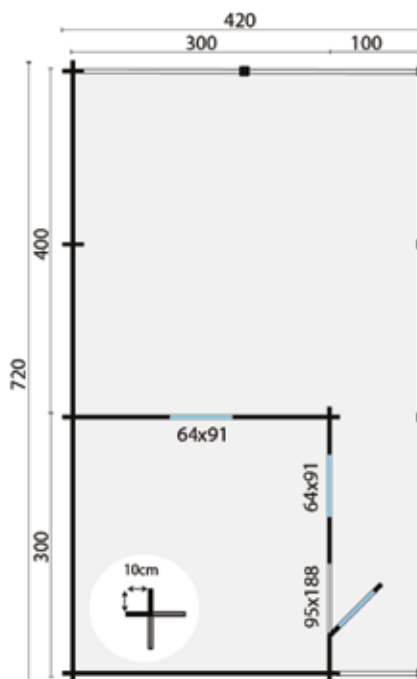

All options can be found from page 399 onwards
 Wooden floor under the Porch, see page 64 and 404

9.0m ²	33.4m ³	21.6m ³	40mm	4mm
19.0m ²				

HENNING - LOG CABIN

Optional roof shingles, straight (42m²)
 Optional roof shingles, beavertail (42m²)
 Optional roof shingles, hexagonal (42m²)

Optional roof tile profile boards (44m²)*
 Optional aquapan

Specifications:

Article no..... 40.0811
 Wood thickness 58mm
 Wood type spruce, untreated
 Dimensions..... 595x390+150cm
 Foundation size 575x520cm
 Ridge height approx. 270cm
 Windows 4 (can be opened)
 Glass double glazing
 Supplied with separate bars for windows and doors

* Tip: When fitting roof tile profile boards we recommend that you also order the wide wind stops

The colour of the gutter planks and wind stops may differ somewhat

Optional extra's

Impregnation: Green, Brown, Silver-Grey
 Impregnating Liquid in Green, Brown, Silver-Grey or Transparent (4)
 Spray-applied base coat: White, Grey, Charcoal, Transparent
 Stain (8)
 Carefree protect (8)
 Starter's set (Nails, air vent & storm anchor set)
 Foundation beams, impregnated 300cm (9)
 Foundation beams, hardwood 300cm (9)
 Foundation beams, synthetic 300cm (9)
 Construction girders, hardwood 4.0x20.0x300cm (9)
 Hardwood stakes with point 6.0x6.0x75cm (45)
 Gutter set plastic 100mm (charcoal)
 Gutter set thermally galvanised 125mm
 Skylight (only with roofing felt and roof shingles)
 Gutter plank (impr. Spruce, necessary for fitting a gutter) (4)
 Roof covering kit (5)
 Glazing kit white
 Wooden floor 18mm (11)
 Wooden floor 18mm impregnated (11)
 Wooden floor 26mm (13)
 Wooden floor 26mm impregnated (13)
 Additional wall layer
 * Wide wind stop (impregnated spruce) (8)

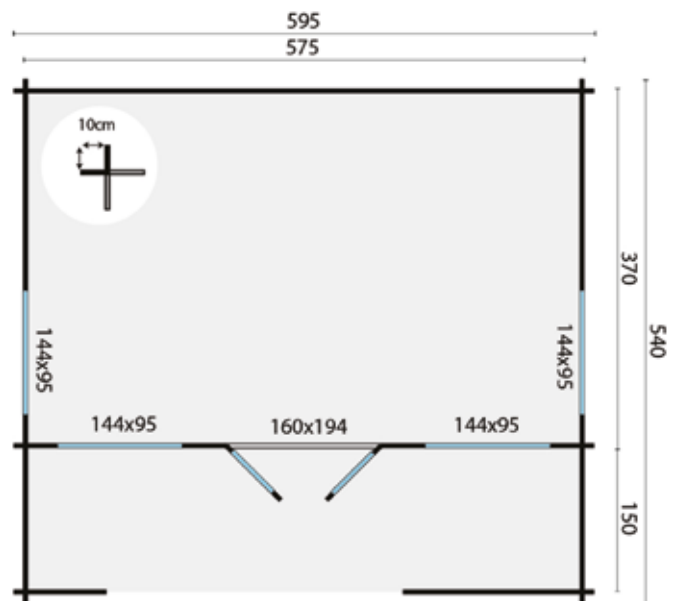

All options can be found from page 399 onwards
 Wooden floor under the Porch, see page 64 and 404

	21.3m ² 8.6m ²		35.1m ²		53.2m ³		58mm		4-6-4 mm
--	---	--	--------------------	--	--------------------	--	------	--	-------------

BERLIN - LOG CABIN



Optional roof shingles, straight (39m²)
 Optional roof shingles, beavertail (39m²)
 Optional roof shingles, hexagonal (39m²)

Optional roof tile profile boards (40m²)*
 Optional aquapan

Specifications:

Article no..... 40.7182
 Wood thickness 44mm
 Wood type spruce, untreated
 Dimensions..... 490x530+70cm
 Foundation size 470x510cm
 Ridge height approx. 344cm
 Windows 4 (can be opened)
 Glass double glazing
 Wooden floor and foundation included
 Supplied with separate bars for windows and double doors
 Can also be constructed in mirror image
 * Tip: When fitting roof tile profile boards we recommend that you also order the wide wind stops
 The colour of the gutter planks and wind stops may differ somewhat

Optional extra's

Impregnation: Green, Brown, Silver-Grey
 Impregnating Liquid in Green, Brown, Silver-Grey or Transparent (5)
 Spray-applied base coat: White, Grey, Charcoal, Transparent
 Stain (9)
 Carefree protect (9)
 Starter's set (Nails, air vent & storm anchor set)
 Gutter set plastic 100mm (charcoal)
 Gutter set thermally galvanised 125mm
 Gutter plank (impr. Spruce, necessary for fitting a gutter) (4)
 Skylight (only with roofing felt and roof shingles)
 Roof covering kit (6)
 Glazing kit white
 Additional wall layer
 * Wide wind stop (impregnated spruce) (8)

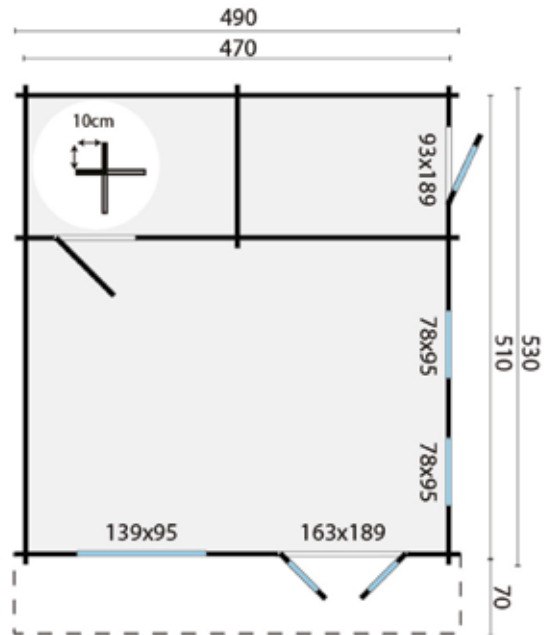

All options can be found from page 399 onwards

24.0m²
 34.4m²
 72.0m³
 44mm
 4-16-4 mm

EDELWEISS - LOG CABIN



Optional roof shingles, straight (42m²)
 Optional roof shingles, beavertail (42m²)
 Optional roof shingles, hexagonal (42m²)

Optional roof tile profile boards (39m²)*
 Optional aquapan

Specifications:

Article no..... 40.0866
 Wood thickness 70mm
 Wood type spruce, untreated
 Dimensions..... 600x510cm
 Foundation size 580x490cm
 Ridge height approx. 365cm
 Windows 6 (can be opened)
 Glass double glazing
 Wooden floor and foundation included
 Supplied with separate bars for windows and doors
 Can also be constructed in mirror image
 * Tip: When fitting roof tile profile boards we recommend that you also order the wide wind stops
 The colour of the gutter planks and wind stops may differ somewhat

Optional extra's

Luxury windows and exterior doors
 Impregnation: Green, Brown, Silver-Grey
 Impregnating Liquid in Green, Brown, Silver-Grey or Transparent (6)
 Spray-applied base coat: White, Grey, Charcoal, Transparent
 Stain (12)
 Carefree protect (12)
 Starter's set (Nails, air vent & storm anchor set)
 Gutter set plastic 100mm (charcoal)
 Gutter set thermally galvanised 125mm
 Gutter plank (impr. Spruce, necessary for fitting a gutter) (4)
 Skylight (only with roofing felt and roof shingles)
 Roof covering kit (6)
 Glazing kit white
 Additional wall layer
 * Wide wind stop (impregnated spruce) (8)

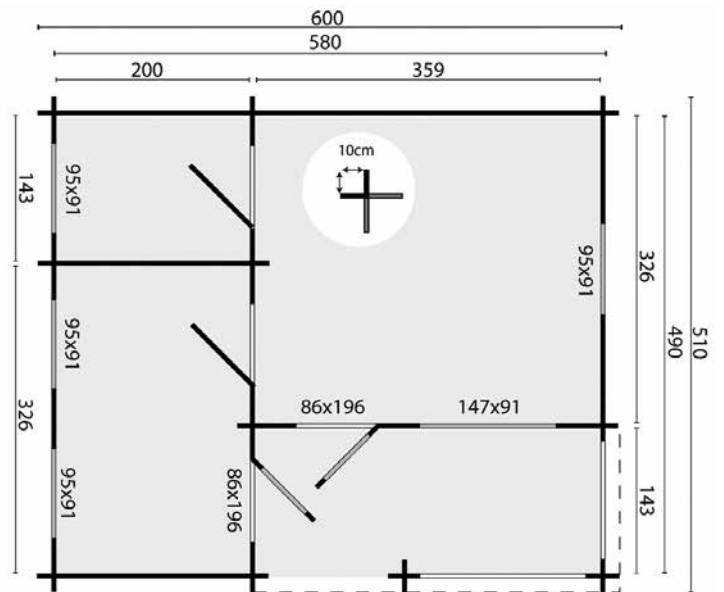

	Standard	Luxury
Wood	Pine laminated	Pine laminated
Window frame thickness	54mm	54mm
Door frame thickness	42mm	54mm
Window glazing	4/14/4mm	4/14/4mm
Door glazing	4/8/4mm	4/14/4mm
Window water gutter	Aluminium	Aluminium
Window opening system	Tilt and turn (2-hand system)	Tilt and turn (1-hand system)
Door lock	Cylinder lock	3 point lock

23.0m²
 5.4m²
 38.2m³
 80.5m²
 70mm
 4-14-4 mm



All options can be found from page 399 onwards

ENNIS - LOG CABIN



Optional roof shingles, straight (45m²)
 Optional roof shingles, beavertail (45m²)
 Optional roof shingles, hexagonal (45m²)

Optional roof tile profile boards (50m²)*
 Optional aquapan

New

Specifications:

Article no..... 40.7318
 Wood thickness 70mm
 Wood type spruce, untreated
 Dimensions..... 534x540cm
 Foundation size 514x520cm
 Ridge height approx. 297cm
 Windows 5 (can be opened)
 Glass double glazing
 Wooden floor (27mm) and foundation included
 Roofboards 27mm (ideal for insulation)..... included
 Supplied with separate bars for windows and doors
 Can also be constructed in mirror image
 * Tip: When fitting roof tile profile boards we recommend that you also order the wide wind stops
 The colour of the gutter planks and wind stops may differ somewhat

Optional extra's

Luxury windows and exterior doors
 Impregnation: Green, Brown, Silver-Grey
 Impregnating Liquid in Green, Brown, Silver-Grey or Transparent (5)
 Spray-applied base coat: White, Grey, Charcoal, Transparent
 Stain (10)
 Carefree protect (10)
 Starter's set (Nails, air vent & storm anchor set)
 Gutter set plastic 100mm (charcoal)
 Gutter set thermally galvanised 125mm
 Skylight (only with roofing felt and roof shingles)
 Roof covering kit (6)
 Glazing kit white
 Additional wall layer

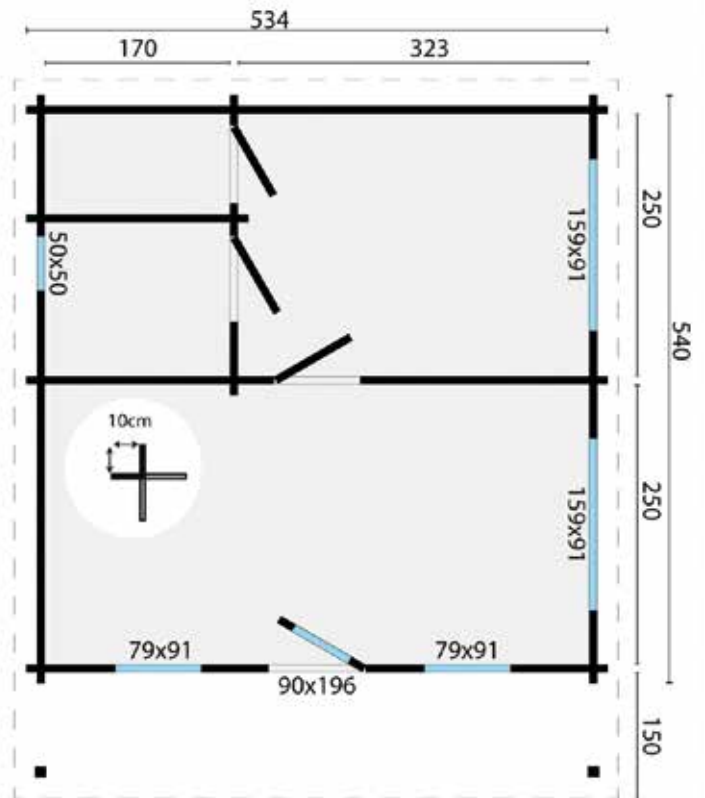

	Standard	Luxury
Wood	Pine laminated	Pine laminated
Window frame thickness	54mm	54mm
Door frame thickness	42mm	54mm
Window glazing	4/14/4mm	4/14/4mm
Door glazing	4/8/4mm	4/14/4mm
Window water gutter	Aluminium	Aluminium
Window opening system	Tilt and turn (2-hand system)	Tilt and turn (1-hand system)
Door lock	Cylinder lock	3 point lock

26.7m²
 33.7m²
 66.7m³
 70mm
 4-14-4 mm

All options can be found from page 399 onwards

KAY - LOG CABIN



Optional roof shingles, straight (63m²)
 Optional roof shingles, beavertail (63m²)
 Optional roof shingles, hexagonal (63m²)

Optional roof tile profile boards (61m²)*
 Optional aquapan

Specifications:

Article no..... 40.0825
 Wood thickness 70mm
 Wood type spruce, untreated
 Dimensions..... 595x800cm
 Foundation size 575x780cm
 Ridge height approx. 317cm
 Windows 6 (can be opened)
 Glass double glazing
 Wooden floor (27mm) and foundation included
 Roofboards 27mm (ideal for insulation)..... included
 Supplied with separate bars for windows and doors
 Can also be constructed in mirror image
 Doors and windows can be placed to the left or to the right
 * Tip: When fitting roof tile profile boards we recommend that you also order the wide wind stops
 The colour of the gutter planks and wind stops may differ somewhat

Optional extra's

Luxury windows and exterior doors
 Impregnation: Green, Brown, Silver-Grey
 Impregnating Liquid in Green, Brown, Silver-Grey or Transparent (8)
 Spray-applied base coat: White, Grey, Charcoal, Transparent
 Stain (16)
 Carefree protect (16)
 Starter's set (Nails, air vent & storm anchor set)
 Gutter set plastic 100mm (charcoal)
 Gutter set thermally galvanised 125mm
 Gutter plank (impr. Spruce, necessary for fitting a gutter) (5)
 Skylight (only with roofing felt and roof shingles)
 Roof covering kit (6)
 Glazing kit white
 Additional wall layer
 * Wide wind stop (impragnated spruce) (8)

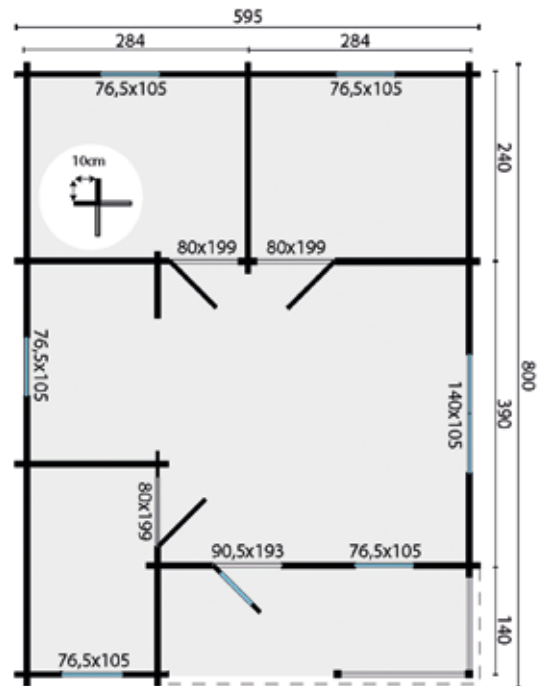

	Standard	Luxury
Wood	Pine laminated	Pine laminated
Window frame thickness	54mm	54mm
Door frame thickness	42mm	54mm
Window glazing	4/14/4mm	4/14/4mm
Door glazing	4/8/4mm	4/14/4mm
Window water gutter	Aluminium	Aluminium
Window opening system	Tilt and turn (2-hand system)	Tilt and turn (1-hand system)
Door lock	Cylinder lock	3 point lock

44.8m²
 55.4m²
 125.0m³
 70mm
 4-14-4 mm

All options can be found from page 399 onwards

FINN - LOG CABIN



- Optional roof shingles, straight (108m²)
- Optional roof shingles, beavertail (108m²)
- Optional roof shingles, hexagonal (108m²)

Specifications:

Article no..... 40.7249
 Wood thickness 92mm
 Wood type spruce, untreated
 Dimensions..... 1040x740+238cm
 Foundation size 1020x720+228cm
 Ridge height approx. 416cm
 Windows 7 (can be opened)
 Glass double glazing
 Wooden floor (27mm) and foundation included
 Roofboards 27mm (ideal for insulation)..... included

This log cabin comes with white plastic doors and windows in the outer walls. Also all doors and windows are so-called residential quality. All windows are fitted with a tilt and turn system with one-handed opening. One of the windows of the double windows is fixed. The log cabin is standard delivered with a "double" roof, 27mm above and 19mm below, you can isolate between them.

Optional extra's

- Impregnation: Green, Brown, Silver-Grey
- Impregnating Liquid in Green, Brown, Silver-Grey or Transparent (14)
- Spray-applied base coat: White, Grey, Charcoal, Transparent Stain (27)
- Carefree protect (27)
- Starter's set (Nails, air vent & storm anchor set) (2)
- Gutter set plastic 100mm (charcoal)
- Gutter set thermally galvanised 125mm
- Gutter plank (impr. Spruce, necessary for fitting a gutter) (7)
- Skylight (only with roofing felt and roof shingles)
- Roof covering kit (12)
- Glazing kit white
- Additional wall layer

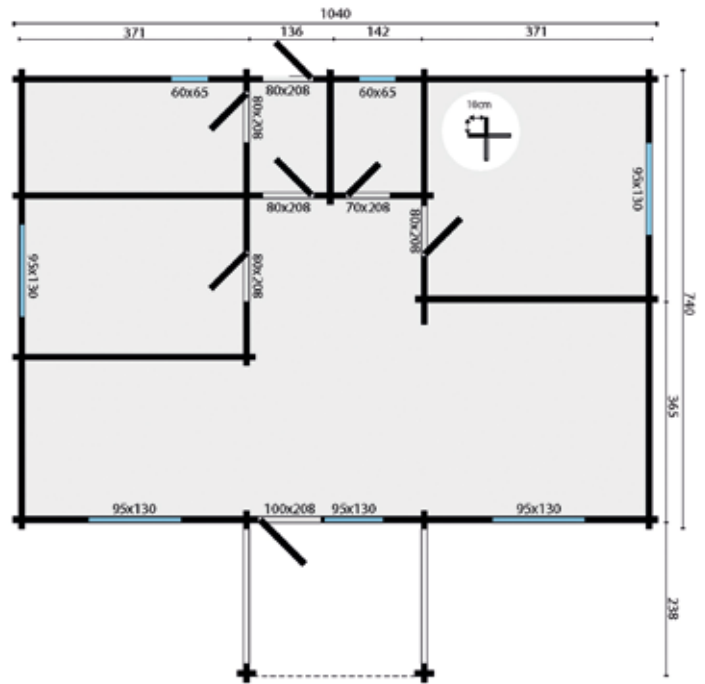

All options can be found from page 399 onwards

68.1m ²	110.0m ²	238.3m ³	92mm	4-16-4 mm
6.2m ²				

OLLIE - LOG CABIN

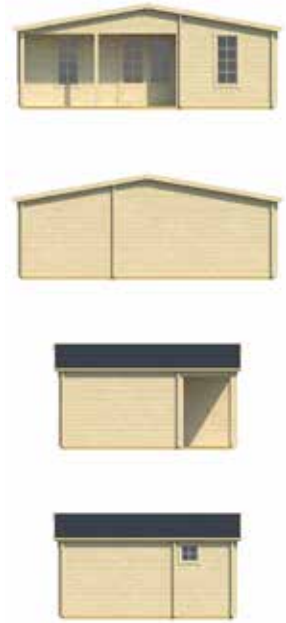

Optional roof shingles, straight (48m²)
 Optional roof shingles, beavertail (48m²)
 Optional roof shingles, hexagonal (48m²)

Optional roof tile profile boards (48m²)*
 Optional aquapan

Specifications:

Article no..... 40.7316
 Wood thickness 70mm
 Wood type spruce, untreated
 Dimensions..... 731+498cm
 Foundation size 711x478cm
 Ridge height approx. 283cm
 Windows 3 (can be opened)
 Glass double glazing
 Wooden floor (27mm) and foundation included
 Roofboards 27mm (ideal for insulation)..... included
 Supplied with separate bars for windows and doors

* Tip: When fitting roof tile profile boards we recommend that you also order the wide wind stops
 The colour of the gutter planks and wind stops may differ somewhat

Optional extra's

- Luxury windows and exterior doors
- Impregnation: Green, Brown, Silver-Grey
- Impregnating Liquid in Green, Brown, Silver-Grey or Transparent (3)
- Spray-applied base coat: White, Grey, Charcoal, Transparent
- Stain (6)
- Carefree protect (6)
- Starter's set (Nails, air vent & storm anchor set)
- Gutter set plastic 100mm (charcoal)
- Gutter set thermally galvanised 125mm
- Gutter plank (impr. Spruce, necessary for fitting a gutter) (4)
- Skylight (only with roofing felt and roof shingles)
- Roof covering kit (6)
- Glazing kit white
- Additional wall layer
- * Wide wind stop (impregnated spruce) (8)

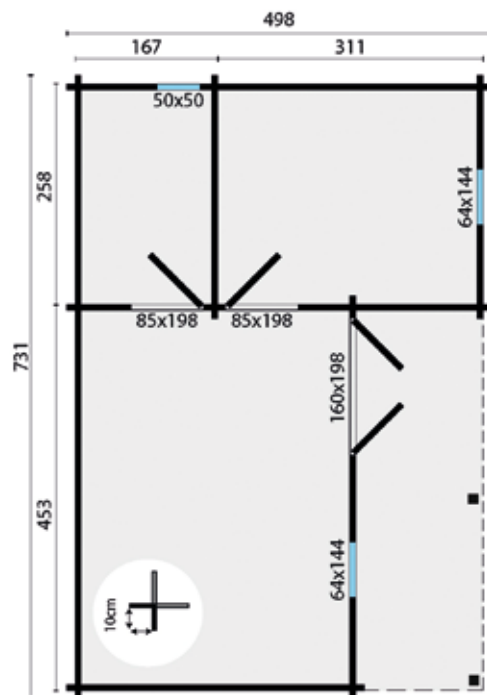

	Standard	Luxury
Wood	Pine laminated	Pine laminated
Window frame thickness	54mm	54mm
Door frame thickness	42mm	54mm
Window glazing	3/9/3mm	3/9/3mm
Door glazing	3/9/3mm	3/9/3mm
Window water gutter	Aluminium	Aluminium
Window opening system	Tilt and turn (2-hand system)	Tilt and turn (1-hand system)
Door lock	Cylinder lock	3 point lock

25.2m²
 6.2m²

 39.6m²

 65.5m³

 70mm

 3-9-3 mm

All options can be found from page 399 onwards

LETTERKENNY - LOG CABIN



Optional roof shingles, straight (90m²)
 Optional roof shingles, beavertail (90m²)
 Optional roof shingles, hexagonal (90m²)

Optional roof tile profile boards (88m²)*
 Optional aquapan

New

Specifications:

Article no..... 40.7317
 Wood thickness 70mm
 Wood type spruce, untreated
 Dimensions..... 1120x595cm
 Foundation size 1100x575cm
 Ridge height approx. 304cm
 Windows 10 (can be opened)
 Glass tempered double glazing
 Wooden floor (27mm) and foundation included
 Roofboards 27mm (ideal for insulation)..... included
 Can also be constructed in mirror image
 * Tip: When fitting roof tile profile boards we recommend that you also order the wide wind stops
 The colour of the gutter planks and wind stops may differ somewhat

Optional extra's

Luxury windows and exterior doors
 Impregnation: Green, Brown, Silver-Grey
 Impregnating Liquid in Green, Brown, Silver-Grey or Transparent (10)
 Spray-applied base coat: White, Grey, Charcoal, Transparent
 Stain (19)
 Carefree protect (19)
 Starter's set (Nails, air vent & storm anchor set) (2)
 Gutter set plastic 100mm (charcoal)
 Gutter set thermally galvanised 125mm
 Skylight (only with roofing felt and roof shingles)
 Roof covering kit (12)
 Glazing kit white
 Additional wall layer

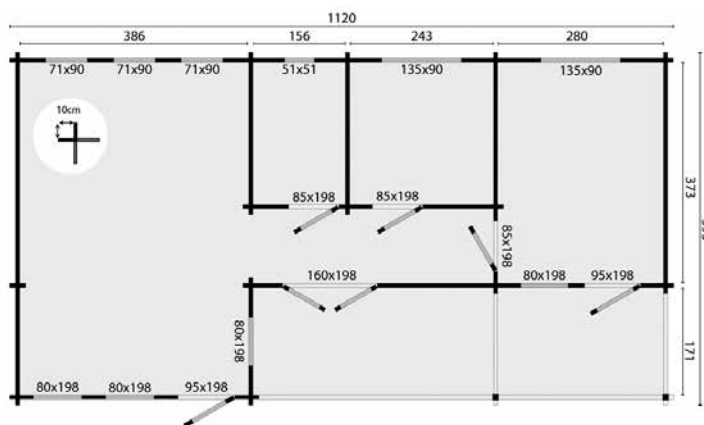

	Standard	Luxury
Wood	Pine laminated	Pine laminated
Window frame thickness	54mm	54mm
Door frame thickness	42mm	54mm
Window glazing	3/9/3mm	3/9/3mm
Door glazing	3/9/3mm	3/9/3mm
Window water gutter	Aluminium	Aluminium
Window opening system	Tilt and turn (2-hand system)	Tilt and turn (1-hand system)
Door lock	Cylinder lock	3 point lock

54m²
 75.4m²
 116.5m³
 70mm
 3-9-3 mm



All options can be found from page 399 onwards

ARDEE - LOG CABIN



Optional roof shingles, straight (69m²)
 Optional roof shingles, beavertail (69m²)
 Optional roof shingles, hexagonal (69m²)

Optional roof tile profile boards (77m²)*
 Optional aquapan

Specifications:

Article no..... 40.7312
 Wood thickness 70mm
 Wood type spruce, untreated
 Dimensions..... 700x817cm
 Foundation size 680x797cm
 Ridge height approx. 317cm
 Windows 6 (can be opened)
 Glass double glazing
 Wooden floor (27mm) and foundation included
 Roofboards 27mm (ideal for insulation)..... included
 Supplied with separate bars for windows and doors

* Tip: When fitting roof tile profile boards we recommend that you also order the wide wind stops
 The colour of the gutter planks and wind stops may differ somewhat

Optional extra's

- Luxury windows and exterior doors
- Impregnation: Green, Brown, Silver-Grey
- Impregnating Liquid in Green, Brown, Silver-Grey or Transparent (5)
- Spray-applied base coat: White, Grey, Charcoal, Transparent Stain (10)
- Carefree protect (10)
- Starter's set (Nails, air vent & storm anchor set)
- Gutter set plastic 100mm (charcoal)
- Gutter set thermally galvanised 125mm
- Gutter plank (impr. Spruce, necessary for fitting a gutter) (5)
- Skylight (only with roofing felt and roof shingles)
- Roof covering kit (7)
- Glazing kit white
- Additional wall layer
- * Wide wind stop (impregnated spruce) (8)

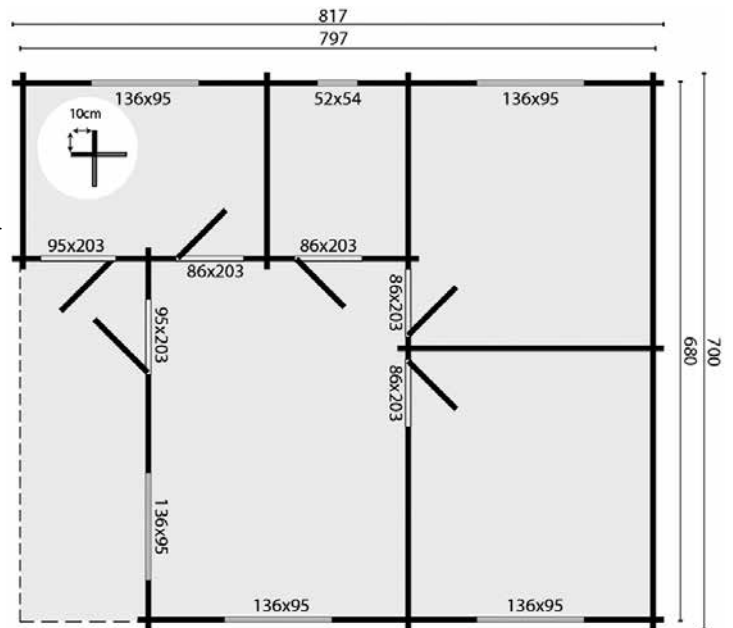

	Standard	Luxury
Wood	Pine laminated	Pine laminated
Window frame thickness	54mm	54mm
Door frame thickness	42mm	54mm
Window glazing	3/9/3mm	3/9/3mm
Door glazing	3/9/3mm	3/9/3mm
Window water gutter	Aluminium	Aluminium
Window opening system	Tilt and turn (2-hand system)	Tilt and turn (1-hand system)
Door lock	Cylinder lock	3 point lock

44.3m²
 64.8m²
 121.8m³
 70mm
 3-9-3 mm

All options can be found from page 399 onwards

AVA - LOG CABIN



Optional roof shingles, straight (39m²)
 Optional roof shingles, beavertail (39m²)
 Optional roof shingles, hexagonal (39m²)

Optional roof tile profile boards (38m²)*
 Optional aquapan

Specifications:

Article no..... 40.7315
 Wood thickness 70mm
 Wood type spruce, untreated
 Dimensions..... 844x347cm
 Foundation size 824x327cm
 Ridge height approx. 270cm
 Windows 4 (can be opened)
 Glass double glazing
 Wooden floor (27mm) and foundation included
 Roofboards 27mm (ideal for insulation)..... included
 Supplied with separate bars for windows and doors* Tip: When fitting roof tile profile boards we recommend that you also order the wide wind stops
 The colour of the gutter planks and wind stops may differ somewhat

Optional extra's

- Luxury windows and exterior doors
- Impregnation: Green, Brown, Silver-Grey
- Impregnating Liquid in Green, Brown, Silver-Grey or Transparent (5)
- Spray-applied base coat: White, Grey, Charcoal, Transparent Stain (10)
- Carefree protect (10)
- Starter's set (Nails, air vent & storm anchor set)
- Gutter set plastic 100mm (charcoal)
- Gutter set thermally galvanised 125mm
- Gutter plank (impr. Spruce, necessary for fitting a gutter) (5)
- Skylight (only with roofing felt and roof shingles)
- Roof covering kit (6)
- Glazing kit white
- Additional wall layer
- * Wide wind stop (impregnated spruce) (6)

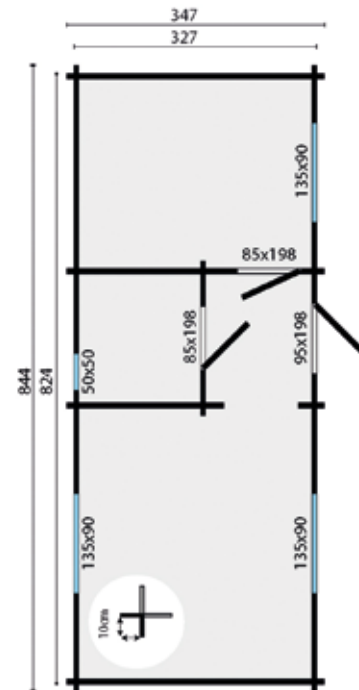

	Standard	Luxury
Wood	Pine laminated	Pine laminated
Window frame thickness	54mm	54mm
Door frame thickness	42mm	54mm
Window glazing	3/9/3mm	3/9/3mm
Door glazing	3/9/3mm	3/9/3mm
Window water gutter	Aluminium	Aluminium
Window opening system	Tilt and turn (2-hand system)	Tilt and turn (1-hand system)
Door lock	Cylinder lock	3 point lock

24.0m²
 32.8m²
 60.0m³
 70mm
 3-9-3 mm

All options can be found from page 399 onwards

MULLINGAR - LOG CABIN



- Optional roof shingles, straight (90m²)
- Optional roof shingles, beavertail (90m²)
- Optional roof shingles, hexagonal (90m²)

Specifications:

Article no..... 40.7310
 Wood thickness 70mm
 Wood type spruce, untreated
 Dimensions..... 850x690+100cm
 Foundation size 830x670 / 270x100cm
 Ridge height approx. 317cm
 Windows 4 (fixed) / 6 (can be opened)
 Glass double glazing
 Wooden floor (27mm) and foundation included
 Roofboards 27mm (ideal for insulation)..... included

Optional extra's

- Luxury windows and exterior doors
- Impregnation: Green, Brown, Silver-Grey
- Impregnating Liquid in Green, Brown, Silver-Grey or Transparent (8)
- Spray-applied base coat: White, Grey, Charcoal, Transparent
- Stain (15)
- Carefree protect (15)
- Starter's set (Nails, air vent & storm anchor set) (2)
- Gutter set plastic 100mm (charcoal)
- Gutter set thermally galvanised 125mm
- Gutter plank (impr. Spruce, necessary for fitting a gutter) (6)
- Skylight (only with roofing felt and roof shingles)
- Roof covering kit (12)
- Glazing kit white
- Additional wall layer

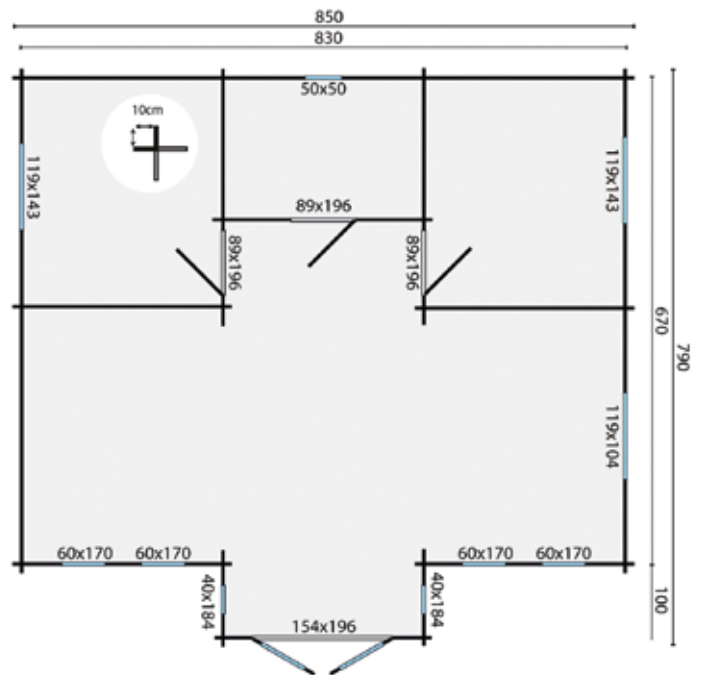

	Standard	Luxury
Wood	Pine laminated	Pine laminated
Window frame thickness	54mm	54mm
Door frame thickness	42mm	54mm
Window glazing	4/14/4mm	4/14/4mm
Door glazing	4/8/4mm	4/14/4mm
Window water gutter	Aluminium	Aluminium
Window opening system	Tilt and turn (2-hand system)	Tilt and turn (1-hand system)
Door lock	Cylinder lock	3 point lock

57.8m²
 58.1m²
 156.0m³
 70mm
 4-14-4 mm

All options can be found from page 399 onwards

SKERRIES - LOG CABIN



Optional roof shingles, straight (96m²)
 Optional roof shingles, beavertail (96m²)
 Optional roof shingles, hexagonal (96m²)

Specifications:

Article no..... 40.7313
 Wood thickness 70mm
 Wood type spruce, untreated
 Dimensions..... 1050x650+50cm
 Foundation size 1030x630 / 230x50cm
 Ridge height approx. 317cm
 Windows 7 (can be opened)
 Glass double glazing
 Wooden floor (27mm) and foundation included
 Roofboards 27mm (ideal for insulation)..... included

Optional extra's

- Luxury windows and exterior doors
- Impregnation: Green, Brown, Silver-Grey
- Impregnating Liquid in Green, Brown, Silver-Grey or Transparent (10)
- Spray-applied base coat: White, Grey, Charcoal, Transparent
- Stain (20)
- Carefree protect (20)
- Starter's set (Nails, air vent & storm anchor set) (2)
- Gutter set plastic 100mm (charcoal)
- Gutter set thermally galvanised 125mm
- Gutter plank (impr. Spruce, necessary for fitting a gutter) (6)
- Skylight (only with roofing felt and roof shingles)
- Roof covering kit (12)
- Glazing kit white
- Additional wall layer

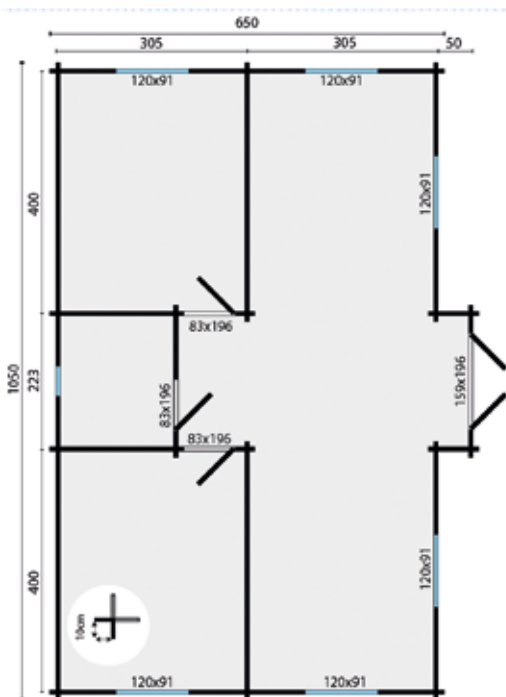

	Standard	Luxury
Wood	Pine laminated	Pine laminated
Window frame thickness	54mm	54mm
Door frame thickness	42mm	54mm
Window glazing	4/14/4mm	4/14/4mm
Door glazing	4/8/4mm	4/14/4mm
Window water gutter	Aluminium	Aluminium
Window opening system	Tilt and turn (2-hand system)	Tilt and turn (1-hand system)
Door lock	Cylinder lock	3 point lock

65.9m²
 87.0m²
 174.5m³
 70mm
 4-14-4 mm

All options can be found from page 399 onwards

AZORES - LOG CABIN



Optional roof shingles, straight (99m²)
 Optional roof shingles, beavertail (99m²)
 Optional roof shingles, hexagonal (99m²)

Optional roof tile profile boards (102m²)*
 Optional aquapan

Specifications:

Article no..... 40.7299
 Wood thickness 70mm
 Wood type spruce, untreated
 Dimensions..... 941x848cm
 Foundation size 921x828cm
 Ridge height approx. 317cm
 Windows 8 (can be opened)
 Glass double glazing
 Wooden floor (27mm) and foundation included
 Roofboards 27mm (ideal for insulation)..... included
 Supplied with separate bars for windows and doors

* Tip: When fitting roof tile profile boards we recommend that you also order the wide wind stops
 The colour of the gutter planks and wind stops may differ somewhat

Optional extra's

- Luxury windows and exterior doors
- Impregnation: Green, Brown, Silver-Grey
- Impregnating Liquid in Green, Brown, Silver-Grey or Transparent (12)
- Spray-applied base coat: White, Grey, Charcoal, Transparent Stain (21)
- Carefree protect (21)
- Starter's set (Nails, air vent & storm anchor set) (2)
- Gutter set plastic 100mm (charcoal)
- Gutter set thermally galvanised 125mm
- Gutter plank (impr. Spruce, necessary for fitting a gutter) (6)
- Skylight (only with roofing felt and roof shingles)
- Roof covering kit (12)
- Glazing kit white
- Additional wall layer
- * Wide wind stop (impregnated spruce) (12)

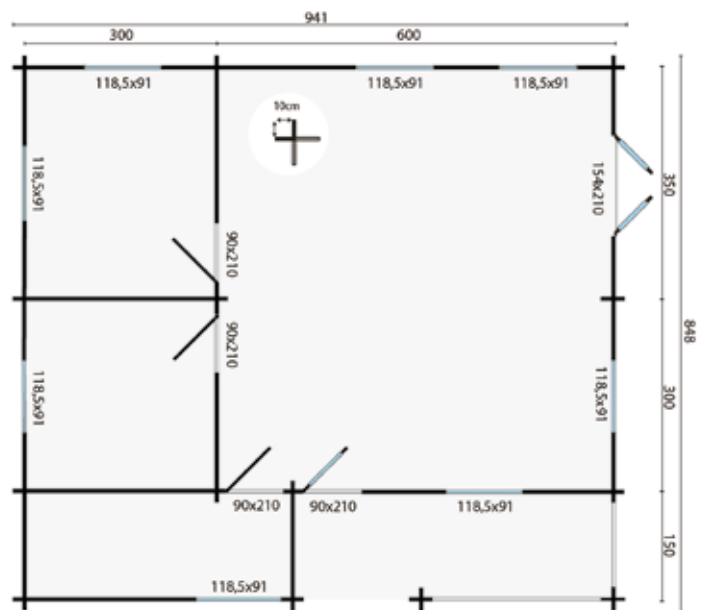

	Standard	Luxury
Wood	Pine laminated	Pine laminated
Window frame thickness	54mm	54mm
Door frame thickness	42mm	54mm
Window glazing	4/14/4mm	4/14/4mm
Door glazing	4/8/4mm	4/14/4mm
Window water gutter	Aluminium	Aluminium
Window opening system	Tilt and turn (2-hand system)	Tilt and turn (1-hand system)
Door lock	Cylinder lock	3 point lock

76.3m²
 86.5m²
 202.4m³
 70mm
 4-14-4 mm

All options can be found from page 399 onwards

LOG CABIN SLANE



Optional roof shingles, straight (90m²)
 Optional roof shingles, beavertail (90m²)
 Optional roof shingles, hexagonal (90m²)

Optional roof tile profile boards (83m²)*

Specifications:

Article no..... 40.7314
 Wood thickness 70mm
 Wood type spruce, untreated
 Dimensions.....1400x490cm
 Foundation size1380x470cm
 Ridge height approx. 287cm
 Windows 7 (can be opened)
 Glass double glazing
 Wooden floor (27mm) and foundationincluded
 Roofboards 27mm (ideal for insulation).....included
 * Tip: When fitting roof tile profile boards we recommend that you also order the wide wind stops
 The colour of the gutter planks and wind stops may differ somewhat

Optional extra's

- Luxury windows and exterior doors
- Impregnation: Green, Brown, Silver-Grey
- Impregnating Liquid in Green, Brown, Silver-Grey or Transparent (10)
- Spray-applied base coat: White, Grey, Charcoal, Transparent Stain (19)
- Carefree protect (19)
- Starter's set (Nails, air vent & storm anchor set) (2)
- Gutter set plastic 100mm (charcoal)
- Gutter set thermally galvanised 125mm
- Gutter plank (impr. Spruce, necessary for fitting a gutter) (8)
- Skylight (only with roofing felt and roof shingles)
- Roof covering kit (12)
- Glazing kit white
- Additional wall layer
- * Wide wind stop (impregnated spruce) (8)



	Standard	Luxury
Wood	Pine laminated	Pine laminated
Window frame thickness	54mm	54mm
Door frame thickness	42mm	54mm
Window glazing	4/14/4mm	4/14/4mm
Door glazing	4/8/4mm	4/14/4mm
Window water gutter	Aluminium	Aluminium
Window opening system	Tilt and turn (2-hand system)	Tilt and turn (1-hand system)
Door lock	Cylinder lock	3 point lock

64.5m²
 76.0m²
 167.7m³
 70mm
 4-14-4 mm

All options can be found from page 399 onwards

Log cabin Big Ben



Log cabin Berlin with extension log cabin



Log cabin Kay





Basic - Kiosk

- Optional roofing felt (16.5m²)
- Optional roof shingles, straight (15m²)
- Optional roof shingles, beavertail (15m²)
- Optional roof shingles, hexagonal (15m²)

Specifications:

Article no.....	40.0178
Wood thickness	16mm
Wood type	impregnated pinewood
Dimensions.....	300x250cm
Foundation size	300x250cm
Ridge height	approx. 260cm
Shutters	2 (can be opened)
Wooden floor and foundation	included
Assembly.....	delivered in wall sections

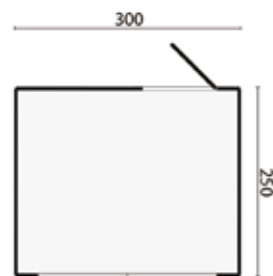

Standaard - Kiosk

- Optional roofing felt (16.5m²)
- Optional roof shingles, straight (12m²)
- Optional roof shingles, beavertail (12m²)
- Optional roof shingles, hexagonal (12m²)

Specifications:

Article no.....	40.0174
Wood thickness	16mm
Wood type	spruce, untreated
Dimensions.....	300x200cm
Foundation size	300x200cm
Ridge height	approx. 251cm
Shutters	2 (can be opened)
Wooden floor and foundation	included
Assembly.....	delivered in wall sections

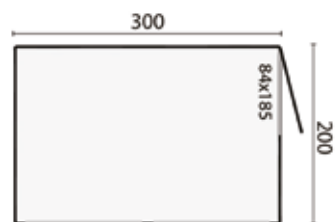

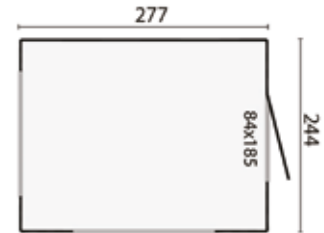

Modern - Kiosk
 Optional roofing felt (13m²)
 Optional EASY-roofing (15m²)
 Optional EPDM (15m²)

Specifications:

Article no.....40.0176
 Wood thickness19mm
 Wood typespruce, untreated
 Dimensions.....277x244cm
 Foundation size277x244cm
 Ridge heightapprox. 234cm
 Windows4 (fixed)
 Shutters2 (can be opened)
 Glasssingle glazing
 Wooden floor and foundation included
 Assembly.....delivered in wall sections
 Can also be constructed in mirror image

Optional extra's

Spray-applied base coat: White, Grey, Charcoal, Transparent Stain (4)
 Carefree protect (4)
 Roof covering kit (3)
 Glazing kit white
 Aluminium Edging Strip (4)
 Aluminium Outer Corner (4)
 Roof Duct, Round included

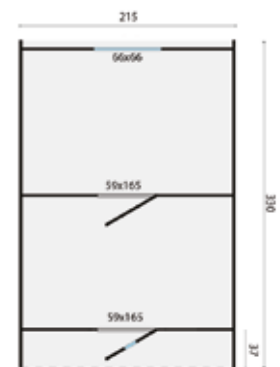

Camping barrel
 Including roof shingles black

Supplied with double bed and including illustrated furniture (table and bed can be removed so that the barrel can function as an office for example).

Specifications:

Article no.....43.7020
 Wood thickness28/42 mm
 Wood typespruce, untreated
 Dimensions.....215x330cm
 Foundation size215x330cm
 Ridge heightapprox. 225 cm
 Windows1 (can be opened)
 Glassdouble glazing
 Fitting kit included
 Wooden floor and foundation included



Camping Oval
Including roof shingles black

The oval is supplied including 2 benches with storage inside and 2 benches outside.

Specifications:

Article no.....	43.7026
Wood thickness	28/42mm
Wood type	thermal wood
Dimensions	405x400cm
Foundation size	200x380cm
Ridge height	approx. 233cm
Glass	double glazing
Fitting kit	included
Wooden floor and foundation	included

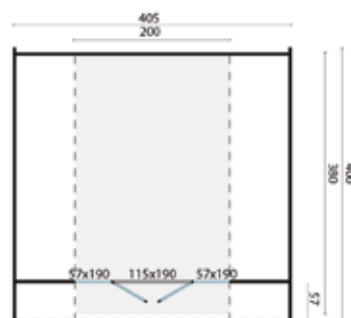

Optional extra's

Thermal Wood is the result of a sustainable and environmentally-friendly process in which only heat is used to enhance the properties of coniferous wood. The thermal treatment of Finnish coniferous wood results in a characteristic brown shaded pattern, giving it a warm and modern appearance.

Moreover, the treatment ensures: increased resistance against moisture, higher level of sustainability (class 2), better shape retention, a light-weight structure.

After some time, you need to treat Thermal wood with oil or stain.



43.7030 Camping POD 400
43.7031 Camping POD 480
Including roof shingles black

Specifications POD 400/480:

Dimensions	240x400/480cm
Foundation size	240x400/480cm
Wood thickness	28 mm
Wood type	spruce, untreated
Ridge height	approx. 230cm
Windows	1 (can be opened)
Glass	double glazing
Fitting kit	included
Wooden floor and foundation	included
Supplied including 2 single beds and 2 benches outside (the beds can also be removed so that the pod can function as an office for example).	

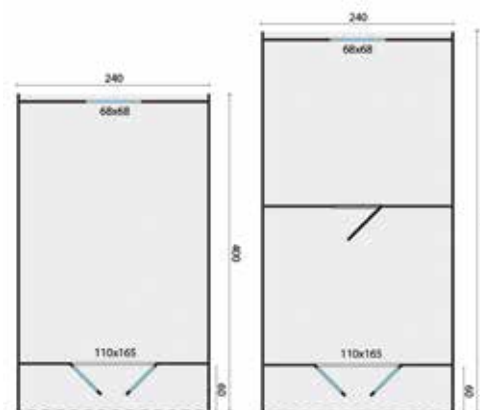

Optional extra's

POD 400 is supplied including 2 single beds and 2 benches outside (the beds can also be removed so that the pod can function as an office for example).

POD 480 is supplied with double bed and including illustrated furniture (table and bed can be removed so that the barrel can function as an office for example).



Tip! Gypsy car from completely isolated inside





Gypsy caravan with veranda
Gypsy Caravan 500 with Veranda, including roofing felt (20m²)

Specifications:

Article no.....40.0170
 Wood thickness19mm
 Wood typespruce, untreated
 Dimensions.....240x418+82cm
 Foundation size240x500cm
 Ridge height including support structureapprox. 319cm
 Windows1 (can be opened), 4 (fixed)
 Glassdouble glazing
 Fitting kitincluded
 Wooden floorincluded
 Static use only! The gypsy caravan is supplied excluding metal support structure and wheels!

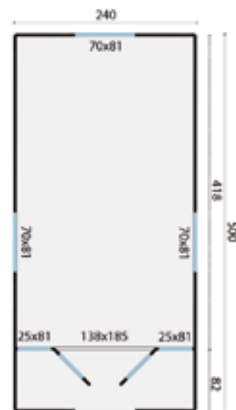

Optional extra's

- 40.0183 - Wheel set
 - 40.0185B - Veranda for side entrance
 - 40.0185A - Veranda for front entrance
 - 40.0185S - Deluxe stairs
- For more information see page 395



Gypsy caravan with side door
Gypsy Caravan 500 with side door, including roofing felt (20m²)

Specifications:

Article no.....40.0179
 Wood thickness19mm
 Wood typespruce, untreated
 Dimensions.....240x500cm
 Foundation size240x500cm
 Ridge height including support structureapprox. 319cm
 Windows1 (can be opened), 4 (fixed)
 Glassdouble glazing
 Fitting kitincluded
 Wooden floorincluded
 Static use only! The gypsy caravan is supplied excluding metal support structure and wheels!

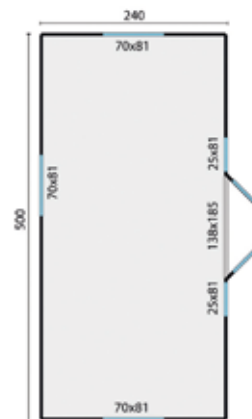

Optional extra's

- 40.0183 - Wheel set
 - 40.0185B - Veranda for side entrance
 - 40.0185A - Veranda for front entrance
 - 40.0185S - Deluxe stairs
- For more information see page 395



Gypsy caravan
Gypsy Caravan 360, including roofing felt (20m²)

Unique panel system where door and windows can be placed anywhere desired. See examples above.

Specifications:

Article no.....	40.0181
Wood thickness	19mm
Wood type	spruce, untreated
Dimensions	237x360cm
Foundation size	237x360cm
Ridge height including support structure	approx. 326cm
Windows	1 (can be opened), 3 (fixed)
Glass	double glazing
Fitting kit	included
Wooden floor and stairs.....	included

Static use only! The gypsy caravan is supplied excluding metal support structure and wheels!

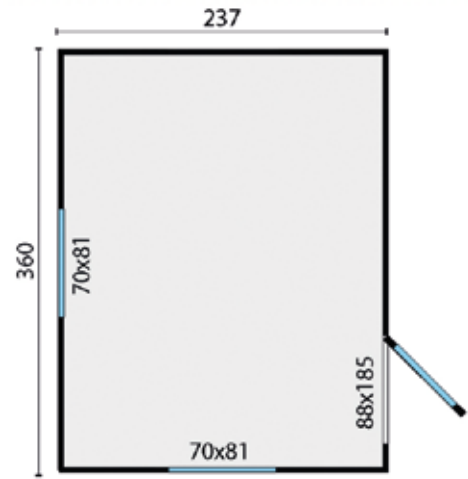

Optional extra's

- 40.0183 - Wheel set
 - 40.0182W - Intermediate wall
 - 40.0184SD - Panel with single door
 - 40.0184SD - Panel with double door
 - 40.0184W - Panel with window
 - 40.0185B - Veranda for side entrance
 - 40.0185A - Veranda for front entrance
 - 40.0185S - Deluxe stairs
- For more information see page 395



Gypsy caravan
Gypsy Caravan 600, including roofing felt (32.5m²)

Unique panel system where door and windows can be placed anywhere desired. See examples above.

Specifications:

Article no.....	40.0182
Wood thickness	19mm
Wood type	spruce, untreated
Dimensions	237x600cm
Foundation size	237x600cm
Ridge height including support structure	approx. 326cm
Windows	2 (can be opened), 2 (fixed)
Glass	double glazing
Fitting kit	included
Wooden floor and stairs.....	included

Static use only! The gypsy caravan is supplied excluding metal support structure and wheels!

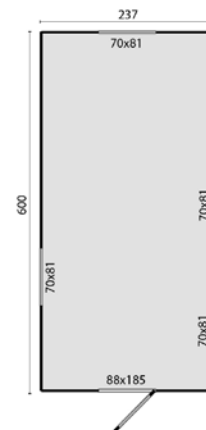

Optional extra's

- 40.0183 - Wheel set
 - 40.0182W - Intermediate wall
 - 40.0184SD - Panel with single door
 - 40.0184DD - Panel with double door
 - 40.0184W - Panel with window
 - 40.0185B - Veranda for side entrance
 - 40.0185A - Veranda for front entrance
 - 40.0185S - Deluxe stairs
- For more information see page 395



Gypsy caravan with veranda
Gypsy Caravan XL, including roofing felt (50m²)

Unique panel system where windows can be placed anywhere desired.

Specifications:

Article no.....	40.0177
Wood thickness	19mm
Wood type	spruce, untreated
Dimensions.....	240x700+120cm
Foundation size	240x820cm
Ridge height including support structure	approx. 326cm
Windows	1 (can be opened), 4 (fixed)
Glass	double glazing
Fitting kit	included
Wooden floor	included

Static use only! The gypsy caravan is supplied excluding metal support structure and wheels!

New

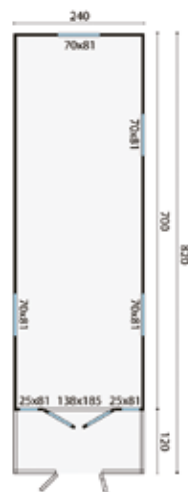

Optional extra's

- 40.0183 - Wheel set
 - 40.0182W - Intermediate wall
 - 40.0184SD - Panel with single door
 - 40.0184SD - Panel with double door
 - 40.0184W - Panel with window
 - 40.0185B - Veranda for side entrance
 - 40.0185A - Veranda for front entrance
 - 40.0185S - Deluxe stairs
- For more information see page 395



Western wagon incl. shingles
Western wagon, including roof shingles

New

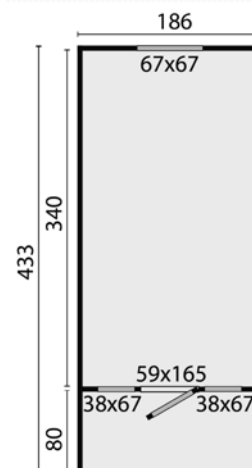

Specifications:

Article no.....	40.0170
Wood thickness	28mm
Wood type	spruce, untreated
Dimensions.....	186x203x433cm
Foundation size	186x433cm
Ridge height including support structure	approx. 270cm
Windows	3 (can be opened)
Glass	double glazing
Fitting kit	included
Wooden floor	included

Static use only! The gypsy caravan is supplied excluding metal support structure and wheels!

Optional extra's

- 40.0183 - Wheel set
- 40.0155 - Beds and table set



Accessories

- 40.0183** Wheel set for gypsy caravan
- 40.0184SD** Panel with shingle door for gypsy caravan (only 360, 600cm and XL)
- 40.0184W** Panel for gypsy caravan (only 360, 600cm and XL)
- 40.0184DD** Panel with double door for gypsy caravan (only 360, 600cm and XL)
- 40.0182W** Intermediate wall for gypsy caravan (only 360, 600cm and XL)
- 40.0185B** Veranda for gypsy caravan with side entrance
- 40.0185A** Veranda for gypsy caravan with front entrance
- 40.0185S** Deluxe stairs for gypsy caravan

W120xH198cm
 W120xH198cm
 Door B138xH198cm / panel: B102xH198cm
 W138xH198cm
 W287xD134xH180cm
 W240xD231xH180cm
 W120cm

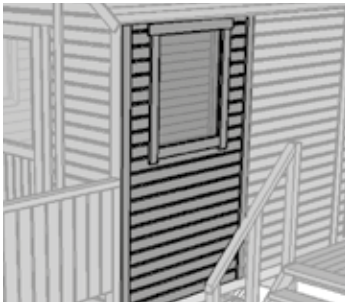

Panel with window

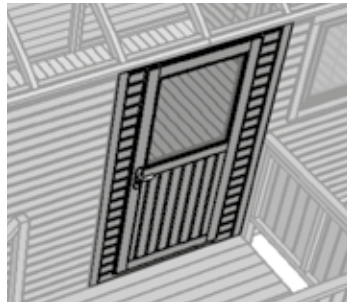

Panel with door



Panel with double door

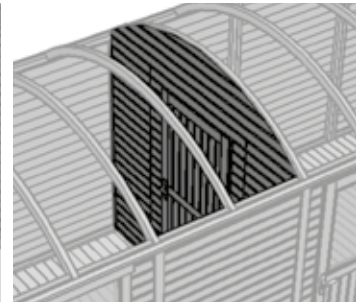

Intermediate wall



Caravan with side entrance



Caravan with front entrance

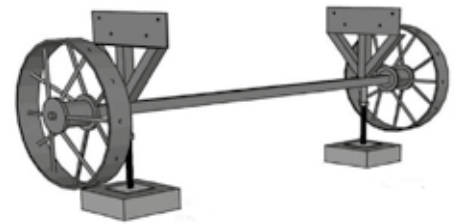

Wheel set





Can't find what you are looking for in our standard assortment?

Then a custom-made log cabin, garage, chalet or holiday home might be something for you. Construction to specification is possible in 28, 40, 44, 50, 58, 70 and 92 mm. You make a sketch of how you want your log cabin to look like and then our specialist guides you step-by-step to realise your dream result. We are happy to send you a measured quotation. On the following pages you will find examples of numerous examples and realised projects. The modification of existing models from this catalogue are among the possibilities.



**Atmosphere and warmth:**

For a comfortable living space, order a double floor and roof prepared for insulation.





Something for you?

Also available with luxury windows and doors (as of 58mm). Laminated wood ensures firmness and resilience. Fitted with doubled-glazed 24mm windows, luxury bracket with multipoint locks and a single hand tilt and turn window.



WOOD PRESERVATIVES

Wood is a beautiful natural material, it is easily worked and can be crafted into virtually any shape imaginable. Wood that is staying outdoors must be protected because if left untreated, it will eventually be affected by the damaging influences of mould, fungi, rain, mist, humidity, wind, storms and sunlight. To prevent this from happening, all wooden components for Log Cabins, Garden Houses, Chalets, Wall Panelling, Fencing, etcetera, must be treated. This protection is achieved by means of impregnation or applying one of our top-quality stains or paints. On the following pages, you will find various products selected and recommended by us.



Impregnation of log cabins

All our Log Cabins are available impregnated. Impregnation increases the life span of the log cabin as this protects the wood against fungus and other processes that may damage the wood. When an impregnated Log Cabin is delivered, it is ready to be constructed in your garden.

Naturally, over time your impregnated log cabin will begin to show signs of weathering and it is important to know that impregnation does not have moisture-regulating properties and does not guarantee wind- and watertight walls and corners.

To achieve this, you will have to paint or stain the log cabin shortly after assembly.

Impregnation is available in a choice of Three colours

Depending on your personal preference, you can choose from one of three Impregnation Colours; Green, Brown or Silver-Grey.

Impregnation Process

A process of immersion /diffusion is used to impregnate the log cabin. This process involves the use of professional impregnating liquids that guarantee long term protection against fungi.

All elements of the log cabin are impregnated, including doors, window frames and shutters, etc. Separate elements such as floorboards can be impregnated. Impregnating liquids may damage the ironmongery in your log cabin. After the impregnation, the log cabin is left to dry naturally and is repackaged.

spray-coating a structure

Your Log Cabin, Arbour, Spruce Building, Garage or Carport can be given an undercoat in one of the following colours, White, Grey, Charcoal or Transparent. The undercoat is applied in two layers. The colour you choose for the undercoat is best determined on the basis of the final colour you are going to apply.

Which parts are coated?

All wall posts, window frames and doors are base-coated with the desired colour. Roof boards are not coated, as that they are covered and protected by the roof covering. We recommend the use of Embadecor/Embalan or Carefree Protect for the final treatment

Impregnating liquid



38.2762	Transparent, 0.75L
38.2763	Silver grey, 0.75L
38.2760	Green, 0.75L
38.2761	Brown, 0.75L
38.2752	Transparent, 2.5L
38.2753	Silver grey, 2.5L
38.2750	Green, 2.5L
38.2751	Brown, 2.5L



CAREFREE PROTECT® - ULTIMATE CONCRETE & WOOD PROTECTION

Is a revolutionary and unique product for maintaining both wood and concrete in optimal condition and providing it with very long-term protection against the effects of the weather, moisture penetration, UV rays and temperature variations. Is based on ultramodern nanotechnology; it is water-based and does not contain any organic solvents. Is very easy to use without any expert knowledge, without time-consuming preparation and without special equipment. Provides a moisture-resistant finish to wood and concrete and is also resistant to algae, fungus and corrosion. Does not have the disadvantage of stains, paints and coatings, such as blistering, colour loss and regular maintenance. Prevents the unattractive calcium formation on concrete products. Has a high penetration capacity whereby the structure of the treated product remains clearly visible. Does not require a primer or undercoat and can be applied directly to a clean and dry surface without any sanding being necessary. Is simple to apply with a paint roller, brush or low-pressure paint spray. Gives a moisture proof protective layer, making cleaning very simple. Is ideally suited to the long-term protection and decoration of wooden products such as log cabins, garden fences, furniture, pergolas and decking planks. Not suitable for hardwood and modified types of wood. Comprehensive handling instructions and useful tips can be found on the website www.carefreeprotect.com

**Carefree Protect**

38.2800	Opaque Black 1L
38.2842	Opaque Black 2.5L
38.2802	Transparent Transparent 1L
38.2810	Transparent Transparent 2.5L
38.2804	Opaque Charcoal 1L
38.2844	Opaque Charcoal 2.5L
38.2805	Transparent Pine 1L
38.2811	Transparent Pine 2.5L
38.2807	Semi-opaque White 1L
38.2840	Semi-opaque White 2.5L
38.2806	Semi-opaque Concrete grey 1L
38.2843	Semi-opaque Concrete grey 2.5L
38.2846	Transparent Light oak 1L
38.2812	Transparent Light oak 2.5L
38.2847	Opaque Green 1L
38.2841	Opaque Green 2.5L

Embalan® is an opaque, silky-gloss paint that you can dilute with water. Embalan® is highly elastic, moisture-regulating and water-repellent and shares several unique qualities with our Embadecor® stains; such as, it does not peel and is UV-stable. Embalan® forms a cocoon in which your wood is protected for many years. If applied correctly Embalan® also prevents your wood from cracking. Embalan® is available in 15 beautiful colours, all of which can be mixed with each other, enabling you to create an entire symphony of colour. You should use a base insulation coat for the first layer under Embalan to ensure the best final result, for this, we recommend our Transparent Embalan Insulation Coat.

**Embalan**

38.2650	Embalan White 2.5L
38.2652	Embalan Grey 2.5L
38.2653	Embalan Black 2.5L
38.2654	Embalan Blue-Grey 2.5L
38.2656	Embalan Prussian blue 2.5L
38.2658	Embalan Carriage green 2.5 L
38.2659	Embalan Red 2.5L
38.2660	Embalan Red-brown 2.5L
38.2666	Embalan Charcoal 2.5L
38.2665	Embalan Insulation Coat 2.5L to prevent light colors from spilling

Embadecor® is a transparent product with active ingredients against the discolouration and damage of the wood through wood-consuming and surface fungi.

Embadecor® is available in 14 natural colours including a transparent option. These stains can be mixed with each other to create stunning and unique colours. Embadecor® not only makes wood weatherproof, but it also enhances the natural characteristics by adding depth, texture and highlighting the beautiful structure of the wood. A unique quality of Embadecor® is that it does not peel, it is UV-stable, emphasises the grain and is water-repellent. It is suitable for all types of wood and is applied using a brush, spray or immersion. Embadecor® can be used as a primary coat for wood that is to be later treated with Embalan® opaque paint.

**Embadecor**

38.2600	Embadecor Transparent 2.5L
38.2601	Embadecor Swedish red 2.5L
38.2602	Embadecor Light pine 2.5L
38.2603	Embadecor Pine 2.5L
38.2604	Embadecor Light oak 2.5L
38.2605	Embadecor Rustic oak 2.5L
38.2606	Embadecor Teak 2.5L
38.2607	Embadecor Walnut 2.5L
38.2608	Embadecor Ebony 2.5L
38.2609	Embadecor Pine green 2.5L
38.2610	Embadecor Chestnut 2.5L
38.2611	Embadecor Mahogany 2.5L
38.2612	Embadecor Silver grey 2.5L

Untreated Northern European spruce doors and windows, including frame, single glazing for log cabins with a wall thickness of 28-44cm
 * LH (left-hinged) RH (right-hinged) - Please note! The dimensions of the windows and doors are rebate dimensions.



40.2007
Stable window L7 44mm
 Dimensions: W70xH50cm



40.2003
Top hinged window W4
 Dimensions: W49xH49cm



40.2002
Top hinged window W3
 Dimensions: W85xH68cm



40.2001
Top hinged window W2
 Dimensions: W112xH77cm



40.2000
Top hinged window W1
 Dimensions: W77xH112cm



Single door D5
40.2014L W83xH190cm LH*
40.2014R W83xH190cm RH*
 Including cylinder lock



Single door D6
40.2015L W83xH190cm LH*
40.2015R W83xH190cm RH*
 Including cylinder lock



Double door D3
40.2012 W159xH190cm
 Including cylinder lock



Double door D2
40.2011 W159xH190cm
 Including cylinder lock



Double door D1
40.2010 W142.5xH190cm **499.95**
 Including cylinder lock



40.2035 Skylight
 W50xH50cm
 Only to be used with roofing felt and roof shingles



39.0260
Cylinder Lock for Log Cabin
 30-35cm



40.1103
Door and Window Shutter
 (twist-lock)

39.0261
Cylinder Lock for Log Cabin
 30-40cm



42.8055
Glazing kit white
 Paintable sealant suitable for sealing joints in single and double glazing



Tilt and Turn Window L5.1
40.2023 W50xH50cm



Tilt and Turn Window L5.2
40.2024 W50xH100cm



Tilt and Turn Window L4
40.2022 W75.5xH96.6cm



Tilt and Turn Window L2
40.2025 W92.0xH92.0cm



Tilt and Turn Window L6
40.2026 W120.0xH92.0cm



Tilt and Turn Window L3
40.2021 W144.5xH96.6cm



Tilt and Turn Window L1
40.2020 W212.0xH96.6cm

Untreated Northern European spruce doors and windows, including frame, with double-glazing for log cabins with a wall thickness of 28-70cm

* LH (left-hinged) RH (right-hinged)

**To place an extra high single or double door in your log cabin, you also need to install 2 additional wall layers.

The doors illustrated on this page are covered with wood on both sides and have insulation between the planks. As in the case of the windows they are sealed with rubber and have a top-quality bracket.

What's more, both the windows and doors have an aluminium weathering.

Please note! The specified dimensions of the windows and doors are rebate dimensions.



Single Door D10
40.2032L W83xH188cm LH*
40.2032R W83xH188cm RH*
Including cylinder lock



Single Door D11
40.2033 W83xH188cm
Including cylinder lock



Extra High and Wide Single Door
40.2017LW99xH209cm LH*
40.2017R W99xH209cm RH*
Including cylinder lock and extra solid hinges



Extra High and Wide Double Door
40.2018L W174xH209cm LH*
40.2018R W174xH209cm RH*
Including cylinder lock and extra solid hinges



Double Door DL7
40.2030 W159xH188cm
Including cylinder lock



Double Door DL8
40.2031 W159xH188cm
Including cylinder lock

NEW Ready-to-use glass modules of Northern European spruce that can be used anywhere. From roofs, preels and log cabins, or to make a wall with it yourself. These modules have a modern look and are supplied with safety glass.



41.3000
Wall module double, impregnated
 W97xH200cm
 With low parapet and safety glass



41.3001
Wall module triple, impregnated
 W145xH200cm
 With low parapet and safety glass



41.3010
Single wall module modern black coated
 W45xH210cm
 With safety glass



41.3011
Double wall module modern black coated
 W99xH210cm
 With safety glass



41.3020
Double door module modern coated black
 W145xH210cm
 With safety glass

New



Foundation beam, impregnated

Dimensions: D4.5xW9.0xL300cm
With drainage profile



- 40.2050** Standard
- 40.2051** Robust for log cabins with 44mm wood thickness or more



Foundation beam, plastic

Dimensions: D3.5xW8.5xL300cm
With drainage profile

- 40.2070** Standard
- 40.2071** Robust for log cabins with 44mm wood thickness or more



Foundation beam, hardwood

Dimensions: D4.5xW9.0xL300cm
With drainage profile

- 40.8050** Standard
- 40.8051** Robust for log cabins with 44mm wood thickness or more



Hardwood girder

Sharp-edged and fine sawn
This can also be used as a foundation girder.

- 2.41930** 4.0x20.0x300cm
- 2.41940** 4.0x20.0x400cm
- 2.41950** 4.0x20.0x500cm



Floor Pack

Floor packs consist of: Floorboards, floorbeams and skirting boards

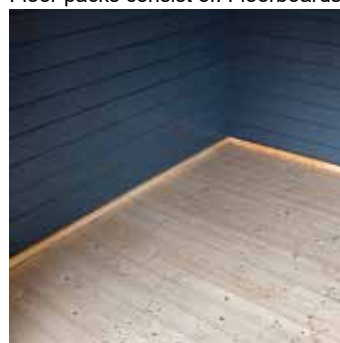

- 40.5007** 18mm - *This is enough for 2.15m²*
- 40.5005** 26mm - *This is enough for 1.66m²*
- 40.5006** Premium 28mm - *This is enough for 1.66m²*
These floor packs are 100% bark-free and have a fixed knot
- 40.5009** 22mm larch/douglas - *This is enough for 1.61m²*

- 1.59350**
Concrete band, charcoal
Dimensions: D9.5xW100xH13cm
With drainage profile

This unique patented product is a result of our successful foundation bar, which has been around for years. The result is a concrete belt with a drainage profile, unique in the market.



Synthetic floor support

Adjustable and made from new plastic

- 40.2073** Adjustable 3 to 6 cm Maximum weight 450 kg
- 40.2074** Adjustable 6 to 14 cm Maximum weight 1400 kg



Impregnation Floor Pack 18 mm

- 40.95007** Impregnation, green floor pack 18mm
- 40.85007** Impregnation, brown floor pack 18mm
- 40.65007** Impregnation, silver grey floor pack 18mm

Impregnation Floor Pack 26 mm

- 40.95005** Impregnation, green floor pack 26mm
- 40.85005** Impregnation, brown floor pack 26mm
- 40.65005** Impregnation, silver grey floor pack 26mm

Impregnation Floor Pack Premium 26 mm

- 40.95006** Impregnation, green floor pack 28mm
- 40.85006** Impregnation, brown floor pack 28mm
- 40.65006** Impregnation, silver grey floor pack 28mm

Accessories

- 40.5017** Nail set for floor pack



- Straight**
40.9970 Roof shingles, straight black
40.9971 Roof shingles, straight red
40.9972 Roof shingles, straight green



- Straight**
40.9973 Roof shingles, straight blue
40.9974 Roof shingles, straight brown



- Beavertail**
40.9980 Roof shingles, beavertail black
40.9981 Roof shingles, beavertail red
40.9982 Roof shingles, beavertail green



- Hexagonal**
40.9985 Roof shingles, hexagonal black
40.9986 Roof shingles, hexagonal red
40.9987 Roof shingles, hexagonal green



Starter set

- Starter set**
40.1120 Starter set 1
 This kit consists of:
 1 garden house kit small,
 1 storm anchor set,
 1 air vent for log cabins
40.1121 Starter set 2
 This kit consists of:
 1 garden house kit large,
 1 storm anchor set,
 1 air vent for log cabins
40.1122 Starter set 3
 This kit consists of:
 2 garden house kit large,
 1 storm anchor set,
 1 air vent for log cabins
40.1107 Asphalt nail, galvanised, 3x15mm Bag of 200
40.1108 Roof board nails, 2.4x50mm (Bag of 200)
40.1109 Garden house kit (800 nails / 800 asphalt nails)
40.1110 Garden house kit (800 nails / 200 asphalt nails)

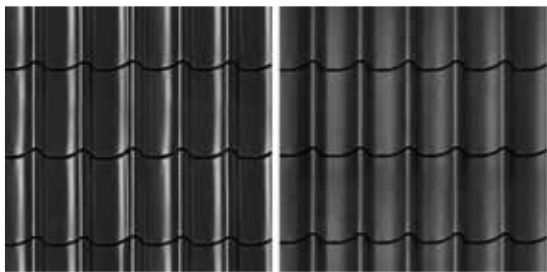
**Roof tile profile boards**

- 40.9930** Roof tile profile boards, black
40.9933 Roof tile profile boards, matt black

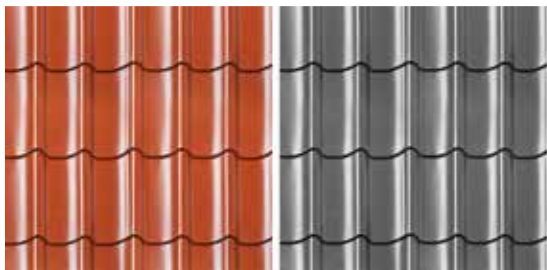
**Roof tile profile boards**

- 40.9931** Roof tile profile boards, terracotta
40.9932 Roof tile profile boards, charcoal

**Aqua-pan**

- 40.9956** Aqua-pan board, red
40.9966 Aqua-pan board, charcoal

Advantages of Aquapan:

Granulate finishing, therefore no shiny surface area

The metal is finished with an aluminium zinc coating

Very easy to install without cutting or sawing

Weights only 6 kg/m²

Minimum roof angle 10 degrees

To prevent condensation and damp formation we advise that you use roofing felt as an underlayer.

Aqua-pan ridge tile and end piece

- 40.9957** Aqua-pan ridge tile, Red
40.9967 Aqua-pan ridge tile, Charcoal
91cm (effective 81cm)

- 40.99571** Aqua-pan ridge capping end piece, Red
40.99671 Aqua-pan ridge capping end piece, Charcoal
(2 per roof)

Aqua-pan wind stop and screws

- 40.9958** Aqua-pan wind stop, Red
40.9968 Aqua-pan wind stop, Charcoal
91cm (effective 81cm)

- 40.99561** Aqua-pan screws, Red
40.99661 Aqua-pan screws, Charcoal
Per 40 (6 per board)



EASY Roofing is a self-adhesive roofing roll fitted on the top side with a UV-resistant aluminium layer. This roll is ideal for practically all surfaces such as lightly slanted roofs, and forms the ideal solution for roof covering of your garden house, garage, carport, etc. The roll is easy and safe to install, which can be done in no time. The aluminium foil on the top has an attractive silver-grey colour, which also provides protection against UV radiation and other environmental influences. A roof angle of 2 degrees is already sufficient.



40.9988E
Easy-roofing aluminium
 Roll of 5 m²



40.9991
EPDM roof covering
 1.14mm thick, to specification per m²

Not for pyramid roofs. LSFR certified for the Dutch construction industry. This certificate shows that the material is fire retardant and withstands extreme temperature variations.

EPDM contact adhesive



40.99892 Tube 0.29L
40.99891 Spray can 0.75L

Aluminium edging strip

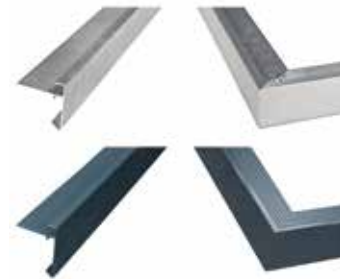

40.1114 L250xW4.5xH4.5cm Aluminium
40.1115 L50xW4.5xH4.5cm Aluminium
40.1116 Coupling element Aluminium
40.1114Z L250xW4.5xH4.5cm charcoal
40.1115Z L50xW4.5xH4.5cm charcoal
40.1116Z Coupling element charcoal

Roof duct, round



43.5110 Roof duct, round
43.5110M Slip coupling



43.5111
Urban grommet, square
 Protrudes from the fascia board at the lowest side between roof and rain pipe.

Roofing felt, grey



40.9994 Per roll 6.5m²
40.9995 Per roll 10m²



40.9990
Bitumenkit
 For roof shingles/roofing felt
 Per tube 310ml

**Roof insulation panel**

- 40.9977** Roof insulation panel 60x120cm
Thickness: 3cm (0.72m²)
Rc Value 1.36M²K/W
- 40.9934** Roof underlay membrane 120gr/m² Roll
W150cmxL50m
- 40.9978** Pressure distribution plate for roof
insulation panel 70mm
- 40.9979** Screws for pressure distribution plate
5.0x45mm

**Log cabin profiles**

Planed spruce

- 40.0959** Log cabin profile, unindented 19mm
- 40.0960** Log cabin profile, unindented 28mm
- 40.0961** Log cabin profile, unindented 34mm
- 40.0962** Log cabin profile, unindented 40mm
- 40.0963** Log cabin profile, unindented 44mm
- 40.0964** Log cabin profile, unindented 58mm
- 40.0965** Log cabin profile, unindented 70mm
- MPKEEP** Additional charge for 2 indents for log
cabin profiles
- 40.1112** Adjustable support for log cabin porch
- 40.0985** Porch support post

**H/I-profielen**

- 40.0324** H/U profile 28 and 34mm
Length: 220cm
- 40.0326** H/U profile 45 and 58mm
Length: 220cm

**Flower planter**

- 40.0361** Flower planter with plastic inner box for
log cabins



40.1111
Finial (without brass ball finial)
Square roof



40.3333
Finial (without brass ball finial)
Hexagonal roof



40.2222
Finial (without brass ball finial)
Octagonal roof



40.4444
Finial (without brass ball finial)
Rectangular roof



40.1111B
Brass ball for finial



40.9976
Air vent for log cabins
 Set of 2
 Including fitting kit



40.1105
Storm anchor set, metal
 Set of 4
 Including bolts

Plastic roof guttering



Gutter set for 2 sides mini-gutter 65cm charcoal

- 40.5400Z** Gutter set complete 400cm
- 40.5401Z** Extension set 200cm (for 2 sides)
- 40.5402Z** Extra outlet set for rainwater, necessary for gutters > 500cm (for 2 sides)

Gutter set for 2 sides valley gutter 100cm charcoal

- 40.5520Z** Gutter set complete 500cm
- 40.5521Z** Extension set 200cm (for 2 sides)
- 40.5522Z** Extra outlet set for rainwater, necessary for gutters > 600cm (for 2 sides)

Gutter set for 4 sides mini-gutter 65cm charcoal

- 40.5410Z** Gutter set complete 400cm
- 40.5403Z** Extension set 200cm (for 4 sides)
- 40.5404Z** Extra outlet set for rainwater, necessary for gutters > 500cm (for 2 sides)

Gutter set for 4 sides valley gutter 100cm charcoal

- 40.5530Z** Gutter set complete 500cm
- 40.5523Z** Extension set 200cm (for 4 sides)
- 40.5525Z** Extra outlet set for rainwater, necessary for gutters > 600cm (for 2 sides)

Gutter pieces charcoal

- | | | |
|--|--|--|
| 40.5900Z Gutter bracket 65cm | 40.5906Z Right corner for rain drainage, 60mm | 40.5912Z Outer corner 100cm gutter |
| 40.5901Z End piece 65cm | 40.5907Z Gutter corner piece for 65cm gutter | 40.5913Z Box gutter 200cm 100cm |
| 40.5902Z Gutter outlet 65>60cm | 40.5908Z Gutter bracket, 100cm | 40.5914Z Gutter coupling element 100cm |
| 40.5903Z Box gutter 200cm 65cm | 40.5909Z End piece left, 100cm | 40.5915Z Gutter corner piece for 100cm gutter |
| 40.5917Z Rain drainage 200cm 60cm | 40.5910Z End piece right, 100cm | 40.5916Z Outer corner 65cm gutter |
| 40.5905Z Gutter coupling element 65cm | 40.5911Z Gutter outlet 100>60cm | 40.5918Z Wall bracket for rain drainage 60cm |

Synthetic gutter set consisting of:

- | | | |
|-------------------|--|------------------------------|
| • Gutter | • Gutter corner piece | • Rain drainage pipe bracket |
| • End cap | • Rain drainage | • Adhesive 125 ml |
| • Gutter brackets | • Rain drainage corner element, 67 degrees | • Coupling element |

Galvanised roof guttering



Gutter set, galvanised 125cm

- 40.5961** Gutter set, galvanised, 2 sides 300cm Ø125cm
- 40.5960** Gutter set, galvanised, 2 sides 600cm Ø125cm
- 40.5962** Gutter set, galvanised, 4 sides 600cm Ø125cm
- 40.5961** Gutter set, galvanised, extension set 2 sides 300cm Ø125cm

125mm round / 0.6mm dik

- | | |
|--|---|
| 40.5945 Gutter 300cm | 40.5944 Connecting pipe between outlet and pipe |
| 40.5939 Rain drainage Ø8cm - 200cm | 40.5946 Gutter bracket |
| 40.5940 Gutter connector (clamping model) | 40.5947 Wall bracket Ø8cm |
| 40.5941 End piece, left, right | 40.5948 Galvanised screw-in pin for wall bracket |
| 40.5942 Gutter outlet | 40.5949 Gutter outflow |
| 40.5943 Rain drainage bend 72° - Ø8cm | 40.5950 Outer corner 90° |



To ensure a proper construction, you need good tools as well as the right fitting materials. Our ironmongery provide you with the accessories you need. Garden timber also has to be maintained well. To give your garden a fresh look, why not check out our post ornaments.

Post ornament, wood

Impregnated pine



- 6.00800** 8.0x8.0cm pyramid
- 6.01000** 10.0x10.0cm pyramid
- 6.10800** 8.0x8.0cm ball/plate
- 6.11000** 10.0x10.0cm ball/plate

Post ornament, galvanised



- 6.20800** 7.1x7.1 cm pyramid
- 6.21000** 9.1x9.1 cm pyramid
- 6.40800** 7.1x7.1 cm ball/plate
- 6.41000** 9.1x9.1 cm ball/plate

Post ornament, copper-coloured



- 6.60800** 7.1x7.1 cm pyramid
- 6.61000** 9.1x9.1 cm pyramid
- 6.80800** 7.1x7.1 cm ball/plate
- 6.81000** 9.1x9.1 cm ball/plate



Spiggot hinge

Per item



- 39.0204** 50cm galvanized
39.0200 60cm Stainless steel
39.0201 80cm Stainless steel
39.0202 90cm Stainless steel



- 39.0265**
Hinge joint stainless steel for larch/douglas doors
 Dimensions: W8.9xH8.9cm
 Thick: 2.5mm



- 39.0210**
Spiggot 38.0x5.0mm
 Per item



- 39.0211**
Spiggot adjustable
 Per item

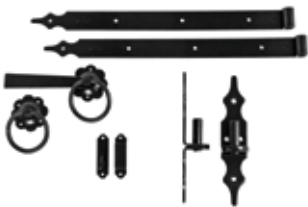

- 39.0220**
Blackline set
 This set consists of:
 2x 60cm hinge
 Closing mechanism
 2 Spigots

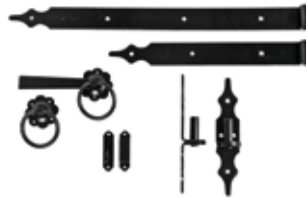

- 39.0221**
Blackline set
 This set consists of:
 1x 60cm hinge
 1x 40cm hinge
 Closing mechanism
 2 Spigots



- 39.0259**
Built-in cylinder lock, stainless steel
 With shields
 Depth casing: 55mm
 Cylinder length: 80mm
 This set consists of:
 door handles, pivot, 100mm spindle



- 39.0258**
Built-in cylinder lock, stainless steel
 With rosette
 Depth casing: 55mm
 Cylinder length: 80mm
 This set consists of:
 door handles, pivot, 100mm spindle



- 39.0252**
Built-in cylinder lock
 Depth casing: 55mm
 Cylinder length: 80mm
 This set consists of:
 door handles, pivot, 90mm spindle



- 39.0264**
Stainless steel built-in cylinder lock, police quality mark
 With aluminium shields
 This set consists of:
 door handles, pivot, 100mm spindle

Cylinder lock

39.0260 30-35mm
39.0261 30-40mm



39.0251
Rim lock
Built-in/mounted lock

39.0253
Automatic gate latch



39.0257
Gate bolt 10cm

39.0250
Gate latch



39.0256
Flip-over gate latch 43cm

39.0255
Push bolt 40cm

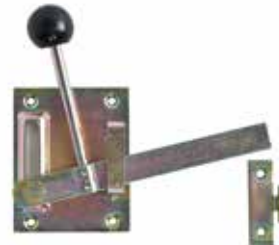

39.0254
Garden gate latch





1.59607
Concrete sinking prevention
D5xØ25cm
 For concrete posts/pad footings



1.59291
Concrete foot padding, charcoal,
mini Dimensions:18x18x10cm
 With bevelled edge
 M20 coupler



1.59250
Concrete Pad Footing, Grey
Dimensions: (18x18)>(15x15)
x50cm
 with rounded edges
 M16 coupler



1.58307
Clamp, galvanised height
adjustment
 3 mm thick
 For posts 12-20cm



1.59251
Concrete Pad Footing, Charcoal
Dimensions: (18x18)>(15x15)
x50cm
 with rounded edges
 M16 coupler



1.58301
Thermally Galvanised Height
Adjustment
 for concrete pad footing with plate
 3 mm thick
 Threaded rod M16

Concrete pad footing, charcoal with bevelled edges



1.59200 Dimensions:
 15x15x60cm
 (M16)



1.59205 Dimensions:
 15x15x60cm
 (M20)



1.58201
Stainless steel height adjustment
 for concrete pad footing with plate
 3 mm thick
 Threaded rod M16

Stainless steel height adjustment
 3 mm thick
 Including screw nut and screw end

1.59280
Concrete pad footing,
charcoal, deluxe Dimensions:
(23.5x23.5)>(20x20)x50cm
 with rounded edges
 M20 coupler



- 1.58315** Deluxe M16
 Footplate: 10x10cm
- 1.58316** Deluxe M20
 Footplate: 10x10cm
- 1.58305** Galvanised M16
 Footplate: 10x10cm
- 1.58306** Deluxe M20
 Footplate: 10x10cm
- 1.58314** Deluxe M16
 Footplate: 8x8cm
- 1.58317** Deluxe M16
 Footplate: 8x8cm





7.77990
Anti-collapsing anchor
Adjustable
 For posts with a thickness up to 15cm. Adjustable in height and width.
 The anchors are secured with quick-drying concrete.

Post support on panel



7.71500 7.1x7.1x13cm galvanised
7.91500 9.1x9.1x15 cm, galvanised
7.12150 12.1x12.1x15cm, galvanised
7.15150 15.1x15.1x15cm, galvanised



7.77995
PVC tube for anti-collapsing anchor Ø12.5xL100cm
 Dig this tube into the soil and fill it with quick-drying concrete for optimal strength, for example with arbours and carports.
 Approx. 2 bags of concrete required per tube.

Post point



7.17900 7.1x7.1x75cm, galvanised
7.19900 9.1x9.1x90cm, galvanised
7.11200 12.1x12.1x90cm, galvanised
7.11500 15.1x15.1x90cm, galvanised



7.12500
Adjustable post support
 12.0x12.0x0.6cm, galvanised

Earth auger



39.0300 Ø7cm, galvanised
39.0301 Ø10cm, galvanised
39.0302 Ø10cm, professional



1.93005
Quick-drying concrete 25kg
 Ready-made, just add water



1.93006
Concrete mortar 25kg
 Ready-made, just add water



A2
inoxCE
EN 14592

Chipwood screw, stainless steel,
double-countersunk head, Pozidrive
Full thread, waxed

Art. no.	∅	l	bit	
39.0061	3.5	25	PZ 2	200
39.0062	3.5	30	PZ 2	500
39.0063	4	25	PZ 2	500
39.0064	4	30	PZ 2	500
39.0065	4	40	PZ 2	500
39.0079	4	70	PZ 2	200
39.0066	4.5	35	PZ 2	200
39.0067	5	50	PZ 2	200
39.0069	5	70	PZ 2	200
39.0088	5	90	PZ 2	200

A2
inoxCE
EN 14592

Chipwood screw, stainless steel,
double-countersunk head, T-drive
Full thread, waxed

Art. no.	∅	l	bit	
39.0800	3.5	30	Tx 15	200
39.0801	4	30	Tx 20	200
39.0802	4	40	Tx 20	200
39.0803	5	50	Tx 25	200

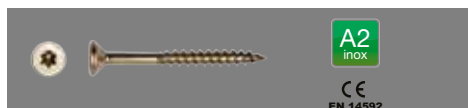
A2
inoxCE
EN 14592

Chipwood screw, stainless steel,
double-countersunk head, T-drive
Partial thread, waxed

Art. no.	∅	l	bit	
39.0085	5	70	Tx 25	200

pfs⁺ - screw €

De PFS+ chipwood screws have a drilling tip, which greatly reduces the risk of cracks occurring in the wood. The wax with which the screws are treated ensures reduced resistance during screwing which saves both time and energy!

GZ
yellow
zinc pl.CE
EN 14592

Chipwood screw, PFS+, double-
countersunk head, T-drive

With 4 milling ribs under the head, special drilling tip type 17, full thread, tempered and waxed

Art. no.	∅	l	bit	
39.0129	3	30	Tx 10	200
39.0130	4	40	Tx 20	200
39.0131	4	50	Tx 20	200
39.0132	4	60	Tx 20	200

GZ
yellow
zinc pl.CE
EN 14592

Chipwood screw, PFS+, double-
countersunk head, T-drive

With 4 milling ribs under the head, special drilling tip type 17, partial thread, tempered and waxed

Art. no.	∅	l	bit	
39.0133	4	70	Tx 20	200
39.0134	5	90	Tx 25	200
39.0135	6	100	Tx 30	100
39.0136	6	120	Tx 30	100
39.0137	6	140	Tx 30	100
39.0138	6	160	Tx 30	100
39.0139	6	180	Tx 30	100
39.0140	6	200	Tx 30	100

CE European Standard
EN14592

Z
zinc pl.

Coach bolt DIN 603 with hexagonal nut DIN
555

Art. no.	∅	l	
39.0110	M8	30	p/item
39.0111	M8	50	p/item
39.0112	M8	70	p/item
39.0114	M8	90	p/item
39.0115	M8	100	p/item
39.0116	M8	120	p/item
39.0117	M8	140	p/item
39.0120	M10	120	p/item
39.0121	M10	140	p/item
39.0122	M10	150	p/item
39.0123	M10	160	p/item
39.0124	M10	220	p/item

Z
zinc pl.

Coach screw DIN 571

Art. no.	∅	l	
39.0150	6	30	p/item
39.0151	6	60	p/item
39.0160	8	30	p/item
39.0162	8	70	p/item
39.0164	8	100	p/item
39.0166	8	120	p/item
39.0169	8	140	p/item
39.0171	10	160	p/item



Fence bracket
39.0015 40cm
39.0011 46cm
39.0012 58cm

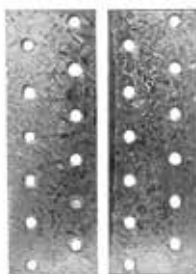

39.0013
Coupling bracket
120x40cm



Reinforcement
corner
39.0005
30x30cm
39.0006
40x40cm
39.0007
90x60cm



39.0014
Wall bracket, square
Set of 2

To be used when
your rainwater
drainage gets in
the way.

Smart[®]

N
nylon

SMART nail plug with countersunk head
With countersunk head and electrolytic galvanised nail

Art. no.	∅	l	
39.0019	6	60	p/item
39.0020	6	80	p/item
39.0022	8	120	p/item



Drill screw (self-tapping)

Art. no.	∅	l	
39.0091	4.2	25	200
39.0081	4.2	32	200
39.0119	4.8	25	200



38.2575
Bangkirai oil 0.75L
 For the treatment of hardwood products
 Prevents hardwood from ageing



38.2582
Decking oil 2.5L
 For the treatment of hardwood decking
 Prevents hardwood from ageing



38.2578
Hardwood oil spray can 0.4L
 For the treatment of hardwood garden furniture

Black tar

For treating wood that contacts the ground

38.0075 0.75L

38.0175 2.5L



38.2579
Hardwood maintenance kit
 This set consists of:
 Brush
 Sanding block
 Grey remover, bottle 0.5L
 Oil in spray can 0.4L
 For the treatment of hardwood garden furniture

Scaffold wood stain

38.2591 White wash, 0.75L

38.2592 Grey wash, 0.75L

38.2596 Charcoal, 0.75L



38.2580
Hardwood oil 0.75L
 For the treatment of hardwood garden furniture
 The addition of wax creates a tough protective layer

Undercoat

For touching up sawn and screwed elements.

38.2595 Black, 1L

38.2597 White, 1L

38.2598 Grey, 1 L



A

Agnes 44mm	334
Aiste 40mm	354
Aksel 28mm	349
Alfsu 28mm	228
Anja 28mm	239
Annabel 40mm	311
Annette 40mm	345
Anton 40mm	302
Ardee 70mm	381
Argo 19mm	232
Arne 28mm	350
Asmund 28mm	325
Ava 70mm	382
Azores 70mm	385

B

Barbara 28mm	225
Berlin 44mm	374
Bertil 44mm	343
Big Ben 70mm	370
Big Lauren 70mm	369
Björn 28mm	241
Blackpool 58mm	276
Bo 28mm	244
Bodine 28mm	305
Bolton 58mm	277
Brenda 28mm	316
Bristol 58mm	278

C

Chappo 28mm	300
Charlotta 28mm	301
Chloe 40mm	352
Christoffer 28mm	338
Clockhouse 44mm	367
Clockhouse Trevor 70mm	368
Coventry 58mm	279

D

Dagmar 28mm	328
Daisy 40mm	351
Daniël 28mm	324
Dellinger 28mm	314
Derby 58mm	280
Diederick 28mm	320
Dora 28mm	299

E

Edelweiss 70mm	375
Eigo 19mm	293
Elin 19mm	308
Emiel 44mm	270
Emma 40mm	327
Ennis 70mm	376
Erickson 28mm	317
Erke 44mm	272
Extramodern 28mm	315

F

Finn 92mm	378
Flow 40mm	312
Freddy 28mm	298
Frodo 44mm	266

G

Georg 28mm	243
Gitte 28mm	237
Gretel 44mm	342
Gudrun 44mm	363
Gunda 40mm	263
Gunnar 44mm	321
Gustav 44mm	268

H

Halvar 28mm	348
Hedvig 44mm	261
Heino 44mm	267
Helge 44mm	335
Hendrick 44mm	269
Henning 58mm	373
Hypermodern 28mm	307

I

Idonea 28mm	246
Inge 44mm	264
Inglund 44mm	257
Ingmar 28mm	249
Ingrid 28mm	326
Ipswich 58mm	281
Irina 19mm	231

J

Johan 34mm	362
Jörgen 28mm	296
Jos 28mm	323
Juha 28mm	250
Julia 40mm	255
Justine 40mm	353
Jutka 44mm	347

K

Kay 70mm	377
Kennet 28mm	337
Klair 28mm	240
Konstantin 40mm	227
Kris 28mm	294
Kukka 40mm	358
Kwaspa 44mm	361

L

Ladyk 28mm	229
Lars 28mm	242
Laula 44mm	265
Leeds 58mm	282
Lennart 58mm	273
Letterkenny 70mm	380
Lilou 40mm	322
Liverpool 58mm	289
Log Cabin 40mm	262
Log cabin 70mm	386
Lory 44mm	309
Lotte 44mm	330
Loya 28mm	297
Lynn 44mm	332

M

Maja 28mm	319
Malva 19mm	234
Manchester 58mm	283
Marit 44mm	226
Markku 28mm	340
Megamodern 28mm	318
Middelmodern 28mm	313
Mika 28mm	248
Mila 28mm	295
Minimodern 28mm	304
Mitch 28mm	224
Mokka 40mm	359
Monne 28mm	230
Mullingar 70mm	383

N

Newcastle 58mm	284
Niklas 28mm	339
Nilsson 44mm	329
Nora 34mm	331
Nottingham 58mm	285
Novalie 19mm	303

O

Olaug 44mm	371
Oletha 40mm	346
Ollie 70mm	379
Olson 44mm	341
Ove 28mm	360

P

Paiva 44mm	344
Perlund 28mm	245

R

Ragna 40mm	372
Richard 28mm	235
Riho 40mm	256
Robert 28mm	236
Roig 28mm	355
Rorik 58mm	274
Rune 70mm	292

S

Sanstrov 44mm	258
Selma 40mm	357
Sheffield 58mm	290
Sibella 44mm	366
Sigrid 28mm	333
Skerries 70mm	384
Skov 28mm	247
Skyler 28mm	251
Sören 44mm	260
Southampton 58mm	286
Sten 28mm	238
Stian 58mm	275
Stig 28mm	336

T

Tane 40mm	356
Torkel 44mm	364
Torsten 58mm	291

U

Ulrik 44mm	259
Ultramodern 28mm	306

V

Valery 19mm	233
Viggo 28mm	252
Viveka 44mm	365

W

Watford 58mm	288
Wigan 58mm	287
Wolfgang 44mm	271

Y

Yorick 44mm	310
-------------	-----

The properties of wood:

Wood is a natural material and has excellent properties, such as:

- Firmness
- Elasticity
- Noise insulation
- Easy to process
- Natural appearance

Because wood is a natural material, it also has the following properties:

- Swelling, shrinking and cracking
- Resin
- Pith
- Knots and flames
- Rough spots and edges
- Salt formation
- Pinholes
- Fungi and bruises
- Gum



Swelling, shrinking and cracking:

The atmospheric humidity level has a profound effect on the volume of wood. It makes wood swell and shrink. This is what we refer to as "warping" of the wood.

Resin:

During the first year after processing, wood can secrete a certain amount of resin which, once it reaches the surface, quickly becomes brittle. It then very soon falls off the wood or can be removed with the aid of a plane.

Pith:

The core of the tree trunk contains pith. This is the tree's food channel and is sometimes confused with wood rot.

Knots and flames:

These are characteristic for wood and give each wood type a different appearance.

Rough spots and edges:

Due to its specific structure, wood can always contain rough spots or edges, even when it has been thoroughly planed or milled.

Salt formation:

Impregnated wood can appear to have salt formation on the outside. This is actually resin that turns yellow/green when the wood is impregnated. These spots disappear after a while.

Pinholes:

These are caused by small wood-eating insects. All such insects are eliminated before the wood is processed into the final product. This has nothing at all to do with woodworm.

Fungi and bruises:

Wood impregnated under boiler pressure becomes very moist, due to which the wood can be affected by mildew and fungi, especially in the summer season. They disappear over time and can easily be removed by hand. The fungi have no effect on the quality and strength of the wood.

Gum:

Hardwood contains gum. This is a brown substance that is released from the wood due to rain and heat. It can discolour surrounding parts.



Understanding that wood is a natural product and may swell or shrink, the dimensions specified in this catalogue may differ slightly from those of the supplied product



LARGEST RANGE
SERVICE & QUALITY
WORLDWIDE
OWN DISTRIBUTION
RELIABLE DISTRIBUTION
ONLINE CATALOGUE
220.000 M² STORAGE AREA

Any text printed in this catalogue is subject to change. The dimensions and colours printed in this catalogue may differ from the supplied product. Interim model alterations may occur, in which case all liability is excluded. Reprinting or partially reprinting this catalogue is forbidden. This catalogue is published by Tuindecò International BV in Coevorden, the Netherlands. All illustrations used in this catalogue are the property of Tuindecò International BV and may not be used without explicit prior approval.